



# ADA- Toilet Rooms, Saunas, and Washer and Dryer



**6**

**Professional Development Hours (PDH) or  
Continuing Education Hours (CE)  
Online PDH or CE course**



## U.S. Access Board Technical Guide

# Lavatories and Sinks

This guide explains requirements in the ADA Standards for lavatories and sinks.

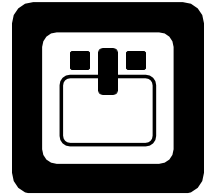

### Required Compliance [§212, §213.3.4]

The Standards cover access to sink and to lavatories, which are sinks used for handwashing in toilet and bathing facilities. At least one lavatory, where provided, must comply in each accessible toilet or bathing room and be located outside a toilet compartment.

Where sinks are provided in accessible rooms or spaces, at least 5%, but no less than one, of each type must comply. This provision applies to sinks in breakrooms, kitchens and kitchenettes, classrooms, and other spaces required to be accessible. Mop or service sinks, which are intended to be used for janitorial or maintenance purposes, are exempt. Other types of sinks used only by employees to perform work are not required to comply (§203.9), although compliance is advisable.



*At least 5% of sinks, but no less than one sink of each type, must comply in each accessible room or space, such as classroom labs (§212.3). At least 5% of work surfaces must also comply (§226.1).*

FDA, Inc

### Lavatories [§606]

Specifications for lavatories address clear floor space for a forward approach, height, faucets, and exposed pipes and surfaces. The Standards also address mirrors, where provided.

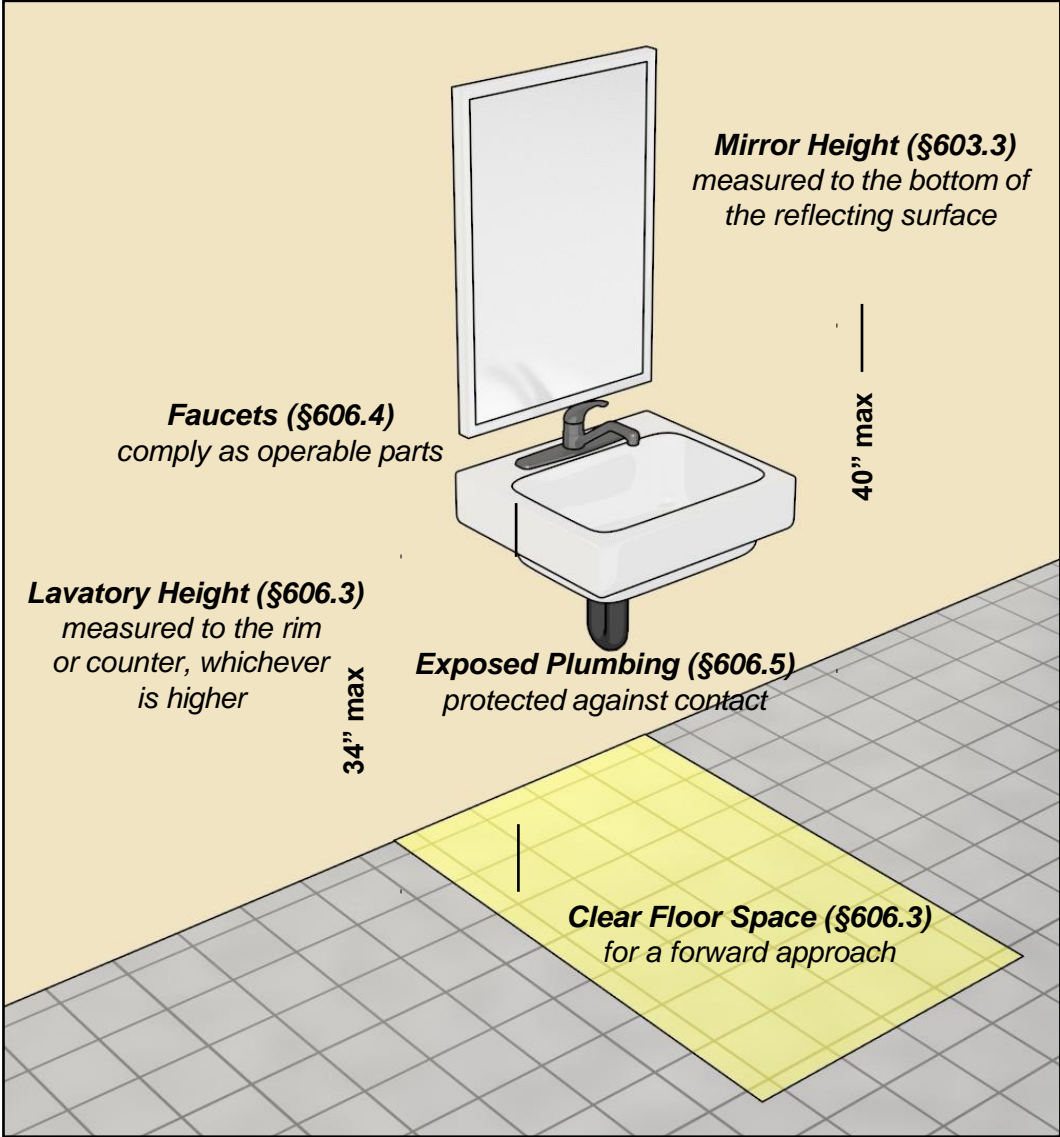

**Recommendation:** Standard size lavatories should be used instead of elongated fixtures that project significantly from walls. Elongated sinks require a greater reach to faucets and controls and reduce available maneuvering space.

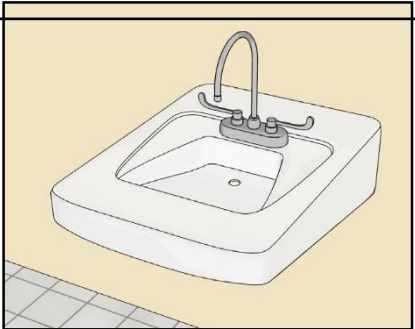

## Sinks [§606]

Sinks are subject to the same criteria as lavatories, but some sinks are permitted a parallel approach instead of a forward approach. In kitchens, kitchenettes, and breakrooms without a cooktop or conventional range, a parallel approach is permitted at kitchen sinks (§606.2, Ex. 1). A parallel approach is also permitted at wet bars (i.e., bars or counters that have sinks with running water and are used for mixing drinks). Where multi-bowl sinks are provided, only one bowl must comply with knee and toe space clearance (§606.2, Ex. 7).

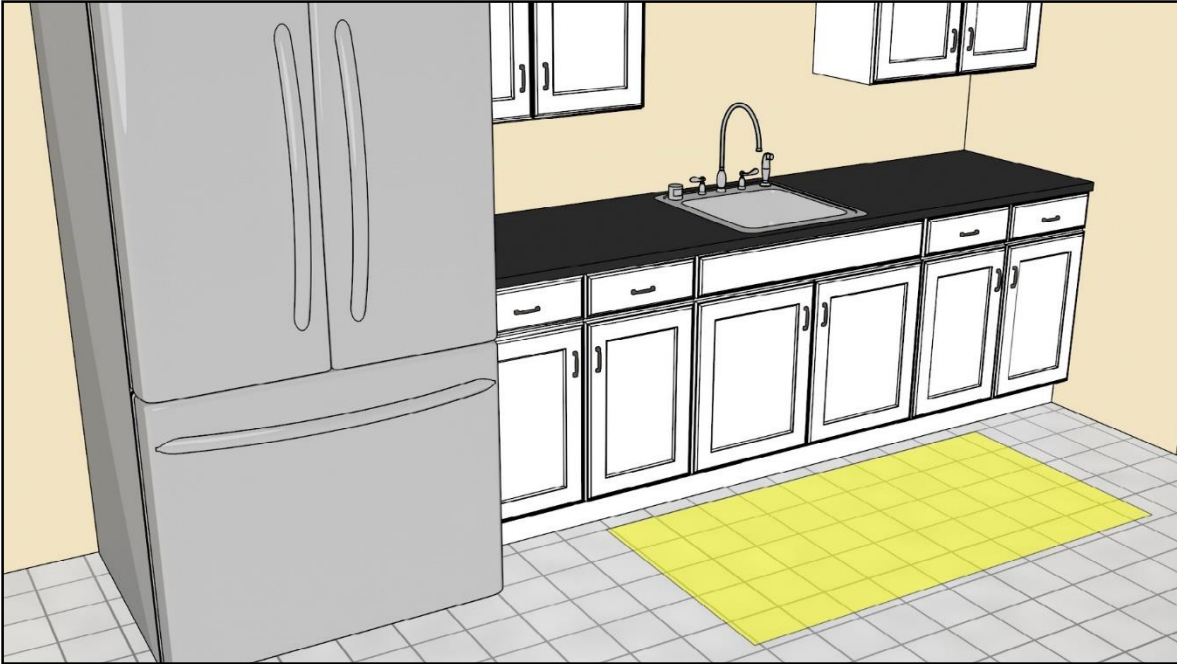

*A parallel approach is permitted at kitchen sinks (i.e., sinks used for food preparation) located in breakrooms, kitchenettes, and similar spaces that do not have either a cooktop or conventional range (§606.2, Ex. 1).*



**Recommendation:** When a parallel approach is permitted to a kitchen sink, it is advisable to provide a forward approach for greater usability. An option is to install cabinet doors that can be opened to provide a forward approach. Make sure that slide-in doors do not obstruct the required clear floor space. However, where a forward approach is required, it is important that the knee and toe space remain clear.



## Lavatories and Sinks in Residential Dwelling Units [§606.2, §606.3]

In mobility accessible dwelling units, lavatories and sinks must comply. Additional exceptions are permitted for fixtures in these facilities.

### Exceptions for Lavatories and Sinks in Residential Dwelling Units

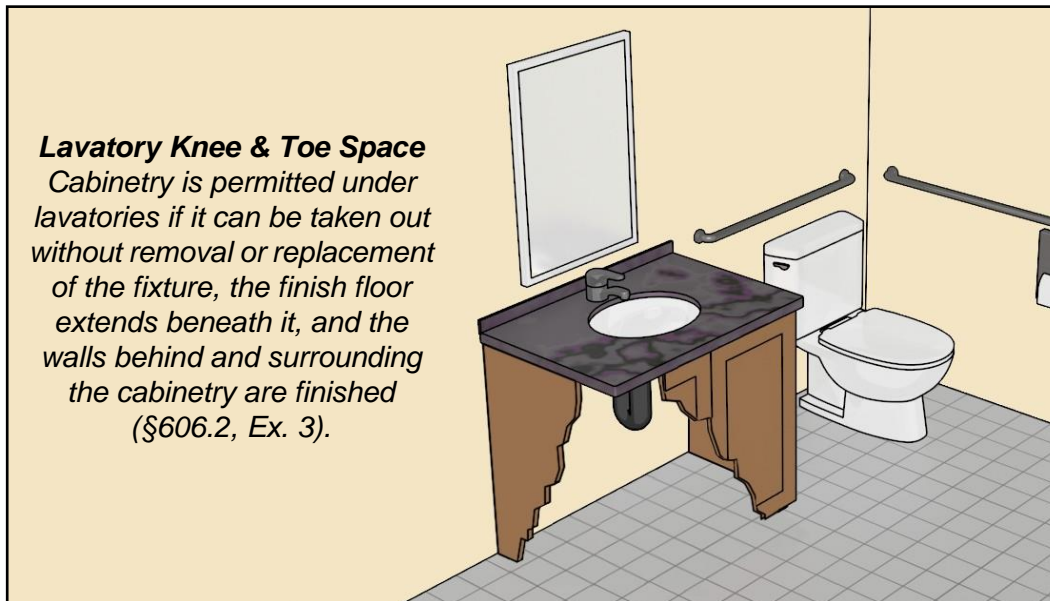

Kitchen sinks that are adjustable to 29" minimum and 36" maximum height are allowed if rough-in plumbing permits connections of supply and drainage pipes for sinks mounted at 29" high (§606.3, Ex. 2).



## Lavatories and Sinks for Children's Use

Specifications based on children's dimensions may be followed when lavatories or sinks are designed primarily for use by children ages 12 and younger. Structured as exceptions, these provisions are optional and serve as alternatives to adult-based dimensions. The Standards do not require building elements, including lavatories and sinks, to be designed or constructed for use primarily by children. This determination is left to other building requirements or regulations, good practice, client preference, or other factors. Exceptions are provided based on two age groups: children 6 to 12 years and children 5 years and younger.

A parallel approach is permitted to lavatories or sinks used primarily by children 5 and younger (§606.2, Ex. 5). For this age group, the standard fixture height is too low to accommodate a forward approach.

### Sink for Children Ages 5 and Younger



*A parallel approach is permitted at sinks and lavatories for children 5 and younger.*

A forward approach is required at lavatories and sinks primarily used by children 6 through 12. However, a lower knee clearance (24" minimum) is permitted if the rim or counter surface is no higher than 31" above the finish floor or ground (§606.2, Ex. 4).

## Clear Floor or Ground Space [§606.2, §305]

Clear floor space at lavatories and most sinks must provide a forward approach and include knee and toe space clearance. It is advisable, but not required, that the clear floor space be centered under the fixture. The knee and toe space must underlie the bowl, faucet controls, and other operable parts of the fixture and must be 17" to 25" deep. If the clear floor space is obstructed on both sides for more than half the depth, such as with alcoves, additional clearance is required for maneuvering.

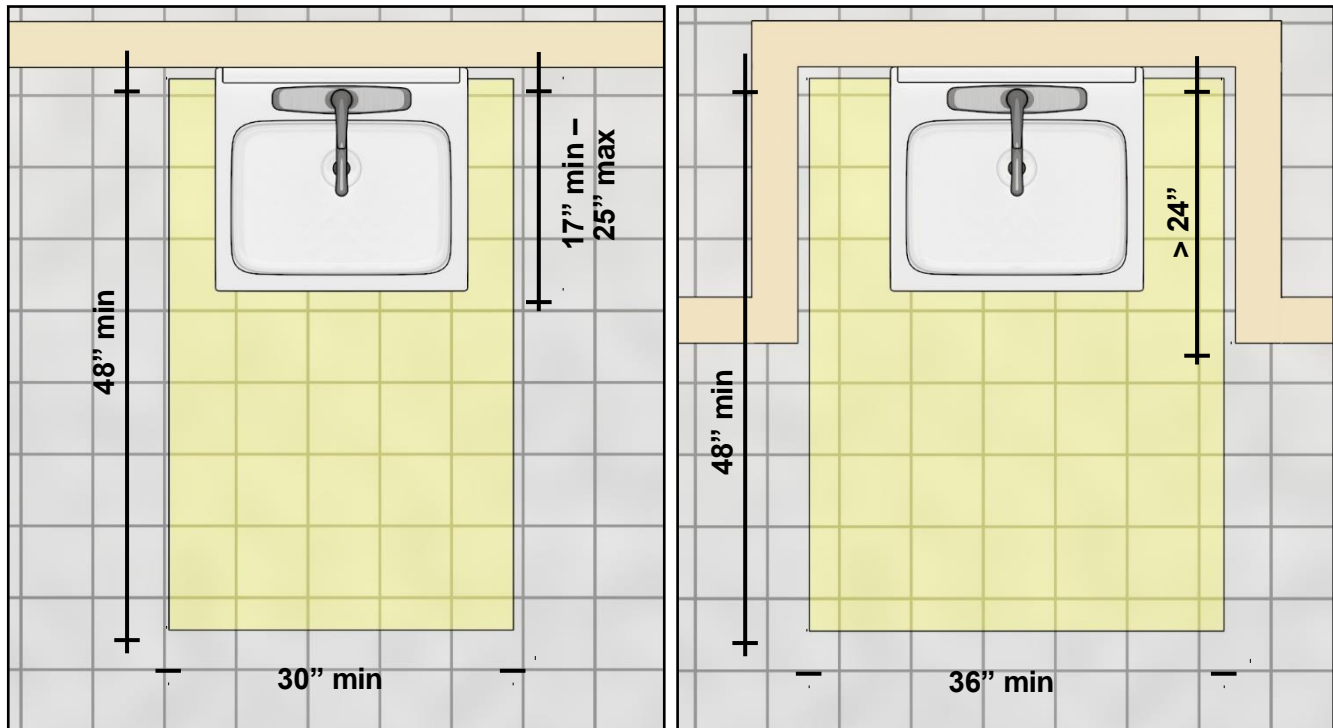

No element, including towel dispensers, hand dryers, etc., can overlap the clear floor space outside the designated knee and toe space.

### Private Office Toilet and Bathing Facilities

In single-occupant toilet rooms or bathrooms accessed only through a private office and not for common or public use, lavatories do not have to meet height or knee and toe space requirements (§606.2, Ex. 2, §606.3, Ex. 1). Where cabinetry is provided below lavatories, it is advisable that cabinetry be readily removable with finish floor below and finished walls behind it, similar to requirements for lavatories in residential dwelling units.

## Knee and Toe Clearances

Knee and toe space must be at least 30" wide and 17" to 25" deep from the leading edge of the clear floor space. These specified clearances allow space for plumbing, enclosures, and supports outside the minimum clearances. No object may protrude into the required clearances other than the dip of the overflow.

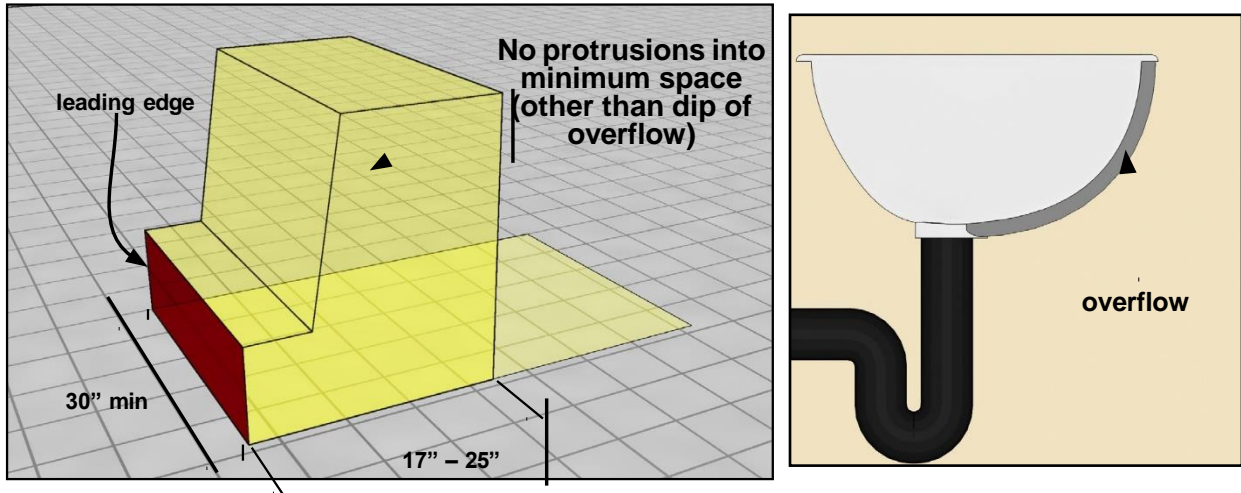

Beyond a depth of 8" measured from the leading edge, the 27" minimum high knee clearance can reduce 18" to a height of 9" minimum (toe space) over a 3" span (6:1 slope). When the knee and toe is deeper than 17", the additional depth must provide full knee clearance at least 27" high.

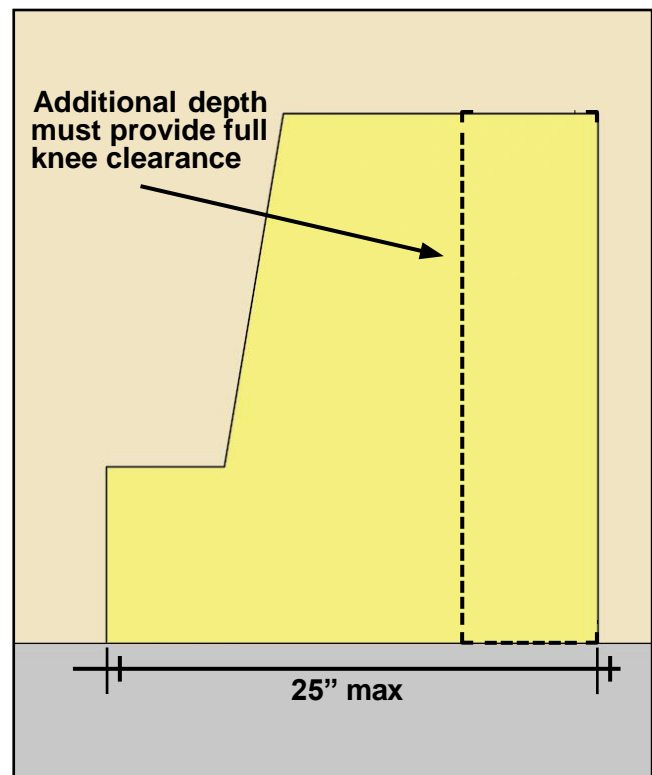
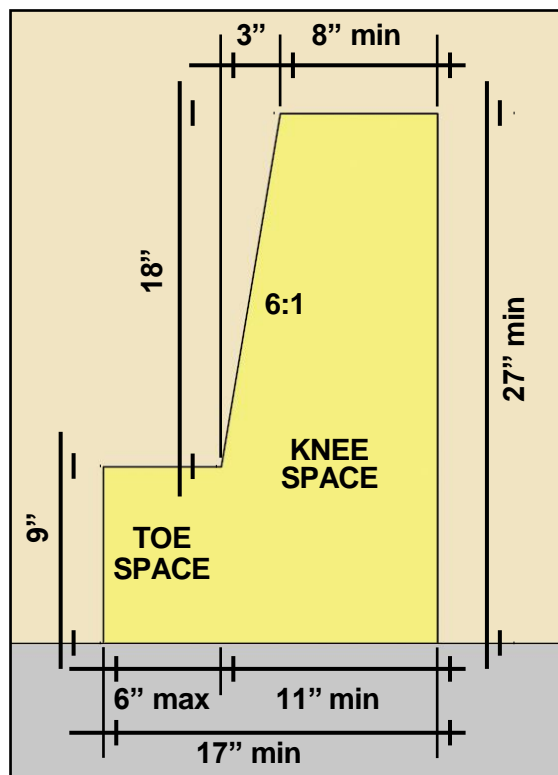



## Knee and Toe Space and Reach Depth

The knee and toe space must be as deep as the required reach to faucet controls, soap dispensers, and other operable parts. This requirement is necessary because the forward reach for most people typically does not extend beyond the toes. Open space beyond the required toe clearance is permitted.

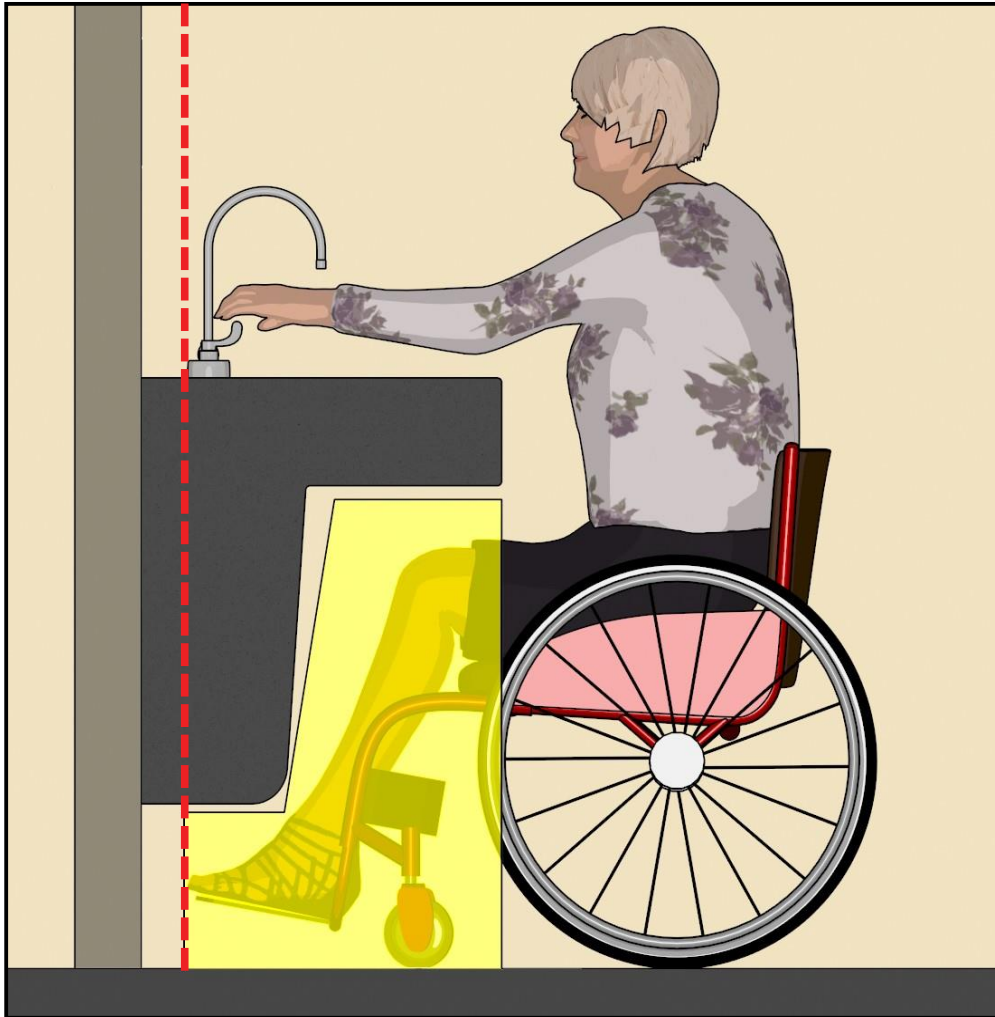

To avoid issues with garbage disposals protruding into knee and toe space, use a sink with a drain located at the rear of the bowl instead of the center. At sinks with two bowls, knee and toe space is required beneath only one bowl (§606.2, Ex. 7).

## Reach at a Lavatory

The maximum reach of 48" is reduced to 44" when the depth of the forward reach over an obstruction exceeds 20".

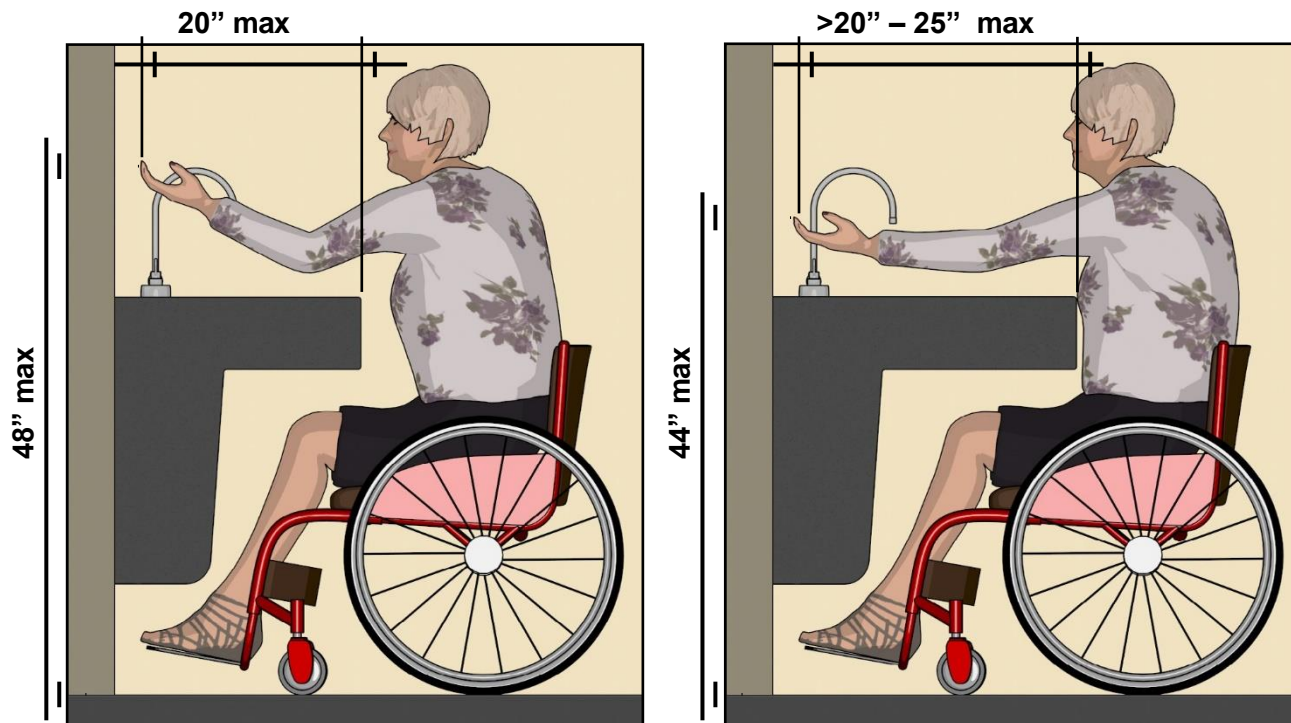

*Recommendation:* Towel dispensers should be usable at the accessible lavatory so that people do not need to operate mobility devices with wet hands. Make sure that dispensers or any other elements do not overlap the lavatory clear floor space outside the designated knee and toe space.

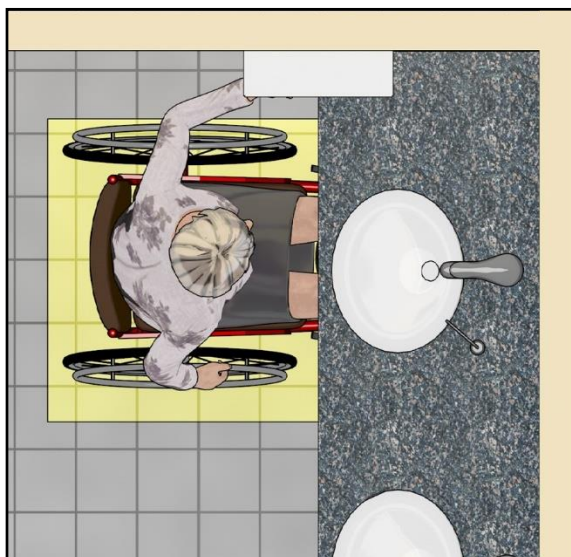



*Recommendation:* When a parallel approach is provided at a sink, locate the fixture and operable parts away from corners so that they are within reach from the clear floor space.

approx. 12"

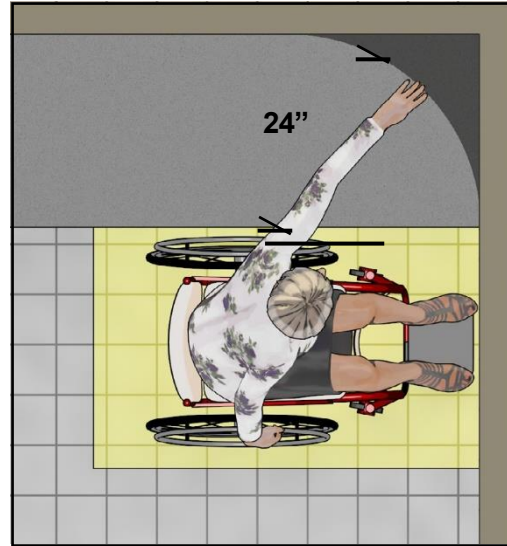
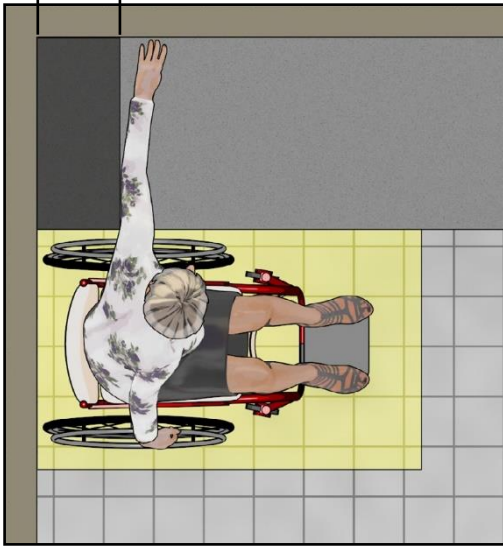

### Faucets [§606.4] and Operable Parts [§205, §309]

Faucet controls, soap dispensers, and other elements that require manual operation must be usable with one hand and not require tight grasping, pinching, or twisting of the wrist, or more than five pounds of force (lbf) to operate. Metering faucets with manual or touch controls must remain open for at least 10 seconds.

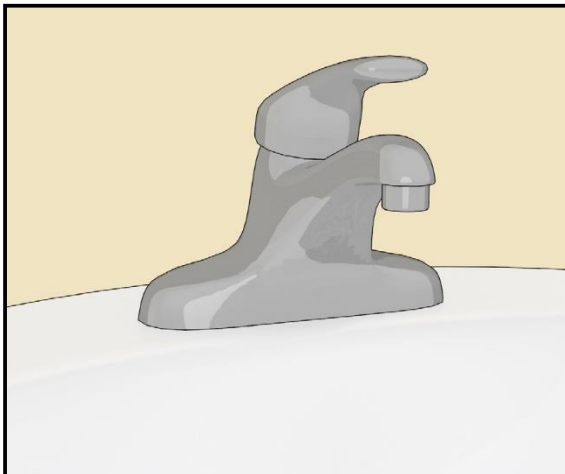

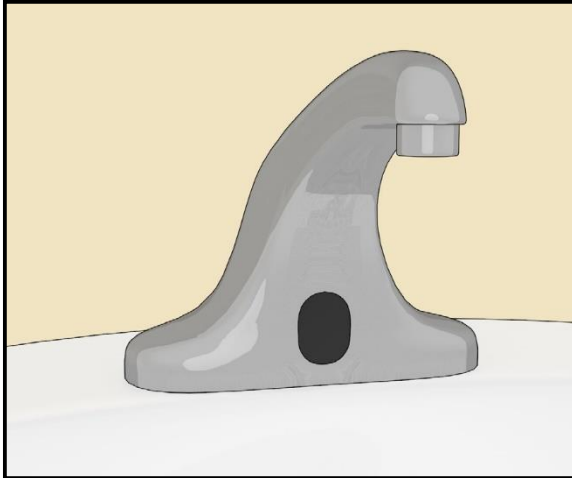

Motion-activated or touch-free faucets and dispensers provide easier access and accommodate a broader range of users. This type of control does not have to remain active for a minimum amount of time.



### **Exposed Pipes and Surfaces [§606.5]**

To avoid injury or burns, water supply and drainage pipes under lavatories and sinks must be insulated, enclosed, or configured to prevent contact. There cannot be sharp or abrasive surfaces under lavatories and sinks. Enclosure of pipes and surfaces must comply with knee and toe space clearance.



*Recommendation:* Where multiple lavatories are provided, insulate pipes at each lavatory since it may not be apparent which fixture is compliant.

## Common Questions



*What type of sinks are exempt as “service sinks”?*

As used in the Standards, the term “service sinks” is similar in meaning as “mop sinks” and refers to sinks used for janitorial or maintenance purposes.

*Are work use sinks required to comply?*

Sinks and other elements used only by employees for work are not required to comply (§203.9). Examples include sinks in restaurant kitchens and in laboratories not used for instruction. Providing access to work use sinks is advisable. Sinks in public and common use spaces not used solely by employees for work, including classrooms and laboratories used for instruction, must comply. Where multiple sinks are provided, at least 5%, but no less than one, of each type must comply (§212.3).

*Are laundry room sinks required to comply?*

Sinks in laundry facilities not used solely by employees for work, such as those provided for use by residents or guests in residential facilities, dormitories, and other transient lodging, must comply. Those located in commercial laundry facilities and used only by employees, as well as mop or service sinks located in laundry rooms, are not required to comply.

*Must the clear floor space at lavatories and sinks be centered?*

No. It is advisable, though not required, that the clear floor space be nominally centered on the fixture. However, the clear floor space must fully underlie the fixture.

*When must sinks or lavatories be designed for use by children?*

The Standards do not specify where sinks or lavatories must be designed specifically for children. This determination is usually made based on other building codes or regulations, good practice, client preference, or other factors. Instead, the Standards provide exceptions that can be used when the decision is made to design fixtures for use primarily by children ages 12 and younger.

*Can pipes, garbage disposals, or other elements protrude into the knee or toe clearance?*

No. Only the dip of the overflow is permitted within the required knee and toe clearance.

*Does space beyond the 6” maximum toe space need to be enclosed?*

No, it does not need to be enclosed. Open space beyond the 6” maximum toe space is permitted.

*How can garbage disposals be accommodated at sinks?*

One option is to select a sink with a drain located at the rear of the bowl instead of the center. Another option is a two-bowl sink where knee and toe space is provided below only one bowl.

*Is the exception permitting a side approach to certain kitchen sinks applicable only to those located in kitchens?*

The exception applies to kitchen sinks (i.e., used for food preparation or cooking) located in break rooms, kitchenettes and kitchens, party rooms, and similar spaces if they do not contain a cooktop or range. Other types of cooking appliances, including microwave ovens, do not impact application of this exception.

*Can a lavatory be located outside of a toilet room?*

Yes. The Standards do not prohibit location of lavatories outside toilet rooms where permitted by codes and other regulations.

*Can a lavatory be provided in a wheelchair accessible toilet compartment?*

Yes. However, the toilet compartment must meet requirements for toilet rooms, including turning space (§604.8). A second accessible lavatory must be provided outside the compartment (§213.3.4).

*Are touch-free (motion sensor) faucets required to remain open for at least 10 seconds?*

No. Manually operated faucet controls that are metered and activate for a set period of time must remain open for at least 10 seconds. Motion-activated faucet controls are not required to remain open for a minimum duration.

*Can accessible mirrors be located above lavatories?*

Yes. Accessible mirrors can be located above lavatories or countertops if the bottom of the reflecting surface is 40" maximum above the finish floor (§603.3). The bottom of the reflecting surface of mirrors not located above lavatories or countertops must be 35" maximum above the finish floor.

*If a toilet room has a full-length mirror and a mirror above a countertop or lavatory, must both types comply?*

No. The Standards require only one mirror in a toilet room to comply. If mirrors are provided above lavatories or counters and at other locations in a toilet room, it is advisable, but not required, that one of each type comply.

*Are lavatories and sinks provided at outdoor locations required to comply with the Standards?*

Yes. At both indoor or outdoor locations, lavatories and sinks that serve accessible facilities or spaces, including, but not limited to, fishing piers, recreational boating facilities, and picnic and camping facilities, must comply.

*Are eyewash stations required to be accessible?*

Yes. Eyewash stations must comply as operable parts (§309), including requirements for clear floor space and controls that are within accessible reach range and operable without tight grasping, pinching, twisting of the wrist, or more than 5 lbf. Products that are usable while standing and from seated positions, including forward approach access at those with basins or bowls, are recommended for greater usability.



**UNITED STATES ACCESS BOARD**

Advancing Full Access and Inclusion for All

1331 F Street, NW ▪ Suite 1000 ▪ Washington, DC 20004-1111  
(202) 272-0080 (v) ▪ (202) 272-0082 (TTY) ▪ [www.access-board.gov](http://www.access-board.gov)

September 2021



## U.S. Access Board Technical Guide

# Saunas and Steam Rooms

This guide explains scoping and technical requirements for saunas and steam rooms in the ADA Standards.

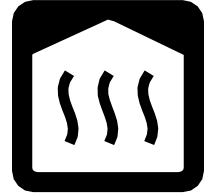

### Required Compliance [§241]

Saunas and steam rooms, where provided, must be accessible. Where two or more saunas or steam rooms are clustered at a single location (i.e., next to, or close to, one another), at least 5%, but no less than one of each type, must comply. Examples of different types include, but are not limited to, those designated by gender or features such as wet or dry heat and temperature capacity.





## Saunas and Steam Rooms [§612]

Requirements for saunas and steam rooms address doors, wheelchair turning space, benches, and controls and other operable parts.

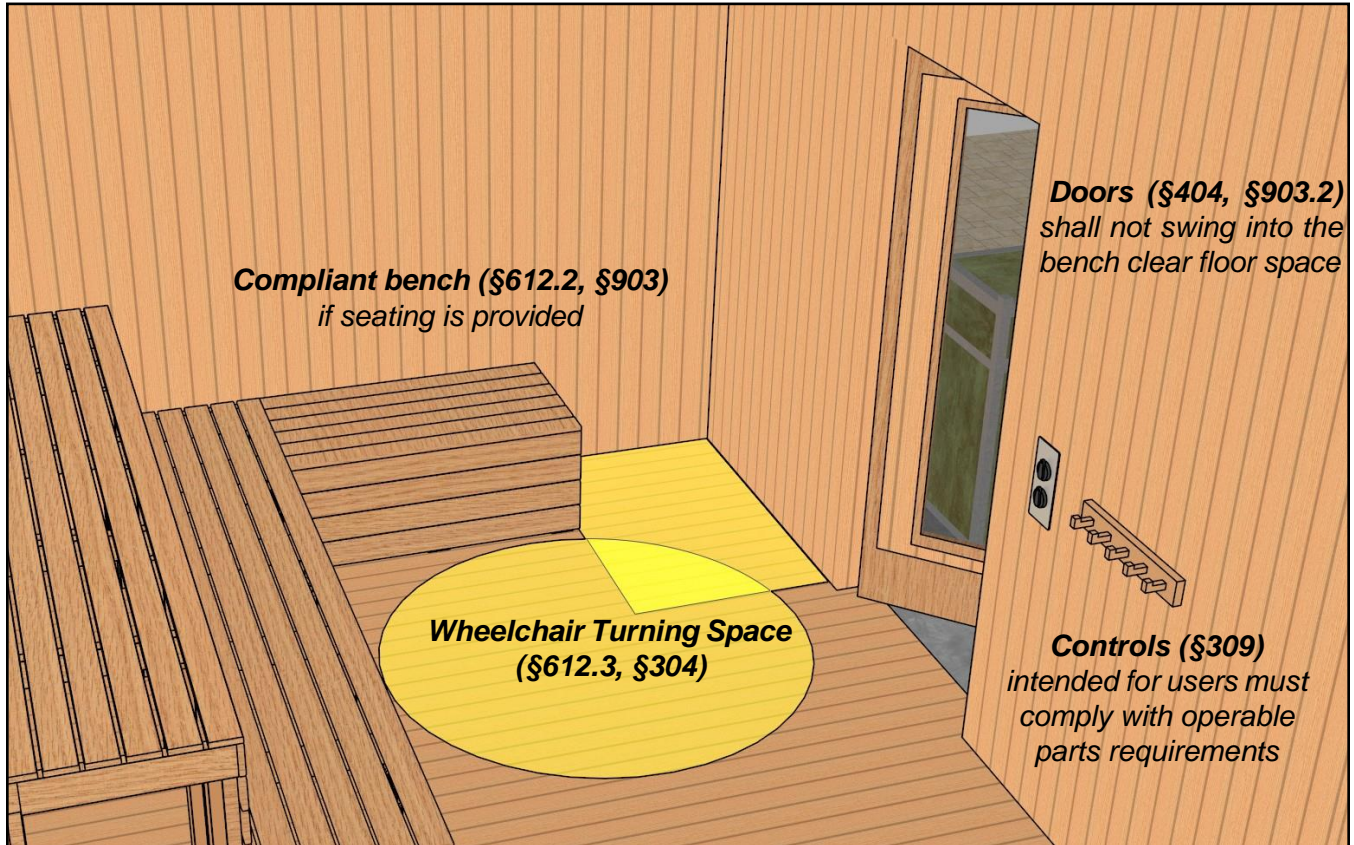

### Turning Space [§612.3, §304]

Wheelchair turning space is required in accessible saunas and steam rooms. This turning space must be a 60" diameter circle or T-shaped. Readily removable benches may obstruct the turning space, but it is advisable that they be placed outside the turning space.

## Benches [§612.2, §903]

Seating in saunas and steam rooms must have at least one compliant bench when seating is provided. The accessible bench must be fixed or built in. Unobstructed clear floor space 30" minimum by 48" minimum is required at the end of the bench and parallel to the short side of the bench. Doors cannot swing into this space. Other readily removable benches may obstruct the clear floor space of the accessible bench, but it is advisable that they be placed outside this space.

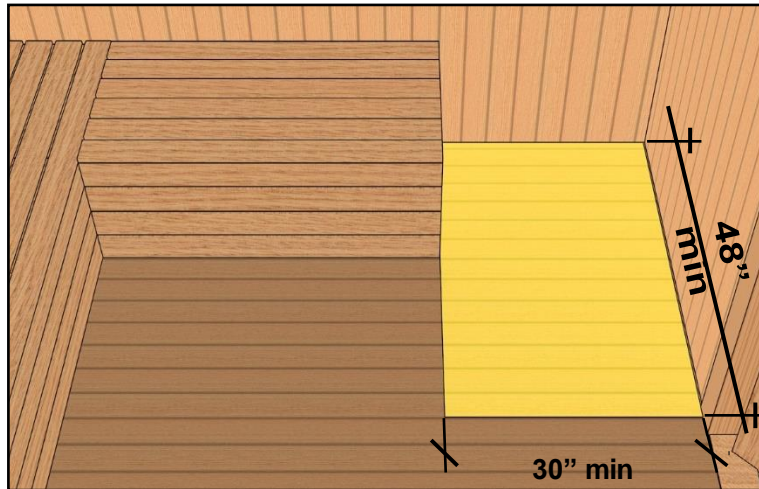

*Clear Floor Space is required at the end of the bench and parallel to the short axis of the bench.*

The seat of the bench must be 42" long minimum, 20" to 24" deep, and 17" to 19" high. Walls may be used as back support for the bench. Benches not fixed to the wall must provide back support that is 42" long minimum, extends from a point 2" maximum above the seat surface to a point 18" minimum above the seat surface, and is 2½" maximum from the rear edge of the seat measured horizontally (§903.4).

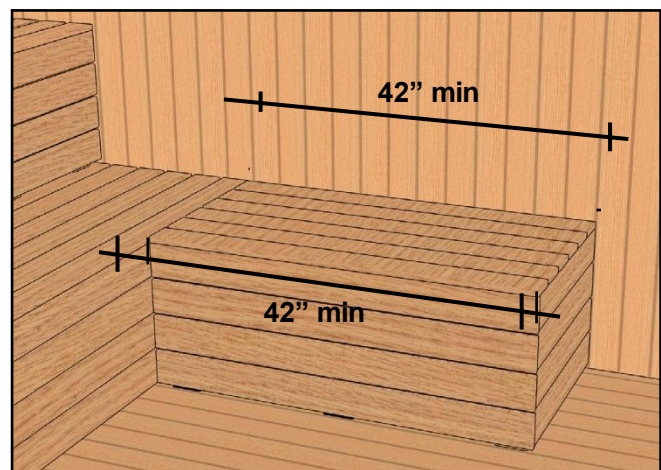
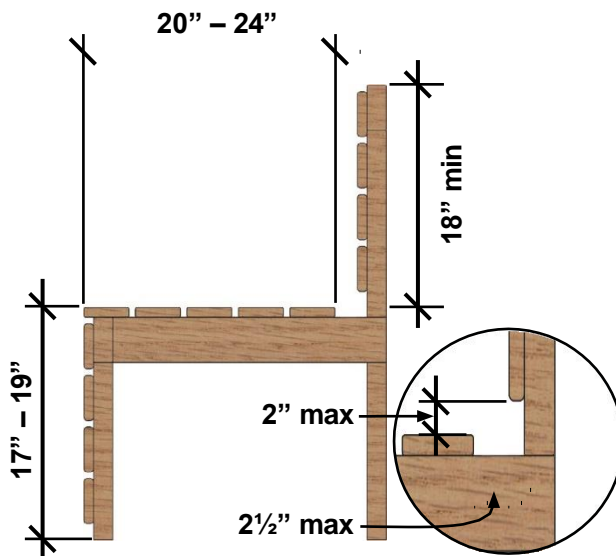

The structural strength of benches and back support must withstand a vertical or horizontal force of 250 lbs. In wet locations, the surface of the seat must be slip resistant and not accumulate water.

## Doors [§404]

Doors to saunas and steam rooms must meet all applicable requirements, including those for clear width (32" minimum), maneuvering clearance, thresholds, hardware, opening force (5 pounds of force maximum), closing speed, and smooth surfacing at the bottom of the push side. Doors that have a window or glazed panel that permits viewing shall have the bottom edge of the panel no higher than 43" above the floor so that it can be used from a seated position. If the bottom edge of a window or glazed panel is higher than 66" above the floor, it is not intended for viewing.

If thresholds are provided at doorways, they cannot exceed  $\frac{1}{2}$ " high. The edge must be beveled 1:2 maximum above a height of  $\frac{1}{4}$ ". Where changes in level are higher than  $\frac{1}{2}$ " because of pre-fabricated unit configurations, compliant ramps and landings must be provided.

If entrance landings and ramps are provided to doors, they must accommodate door maneuvering clearances. Maneuvering clearances for wheelchairs apply to both sides of the entry door. Doors cannot swing into the clear floor space required at benches.

For more information on door requirements, see the *Entrances, Doors, and Gates Guide*.

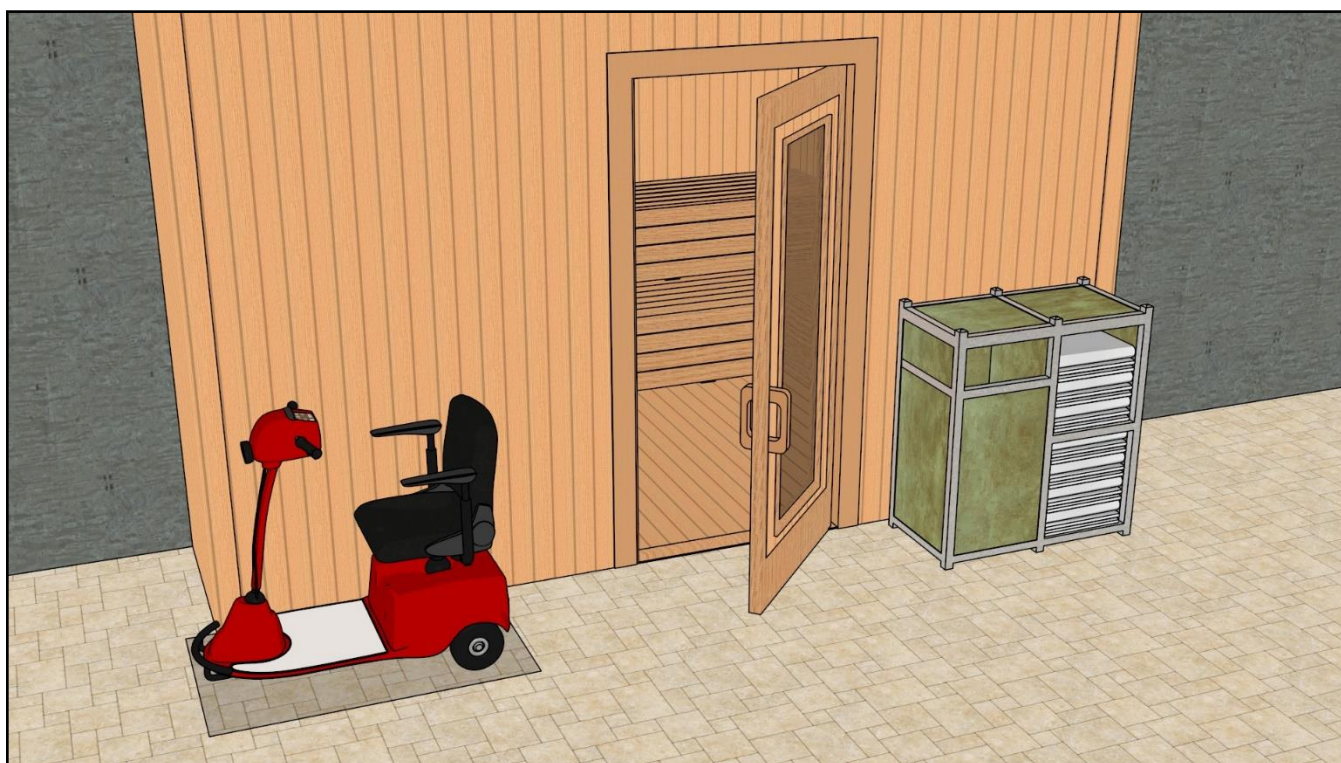

*Recommendation:* Some users may leave their mobility device outside the sauna or steam room. Where possible, space should be available outside saunas or steam rooms and near the entrance (but outside the door maneuvering clearance) for mobility devices.

## Common Questions



*Is access required to all saunas or steam rooms when clustered?*

Where two or more saunas or steam rooms are clustered at a single location, no more than 5% of the saunas and steam rooms, but no fewer than one, of each type in each cluster shall comply (§241).

*Can the entrance to saunas and steam rooms be ramped?*

Yes, ramps can serve accessible routes to saunas and steam rooms. However, ramp landings and door maneuvering clearances must be level. Entrance landings must also be designed to accommodate door maneuvering clearances.

*Is space for storing a wheelchair or other mobility device required?*

No, wheelchair storage space is not required, but it is advisable to provide adequate space outside of the accessible route and door maneuvering clearance for those who wish to leave their mobility device outside the sauna or steam room.

*Do requirements for floor or ground surfaces apply to saunas and steam rooms?*

Yes, floor or ground surfaces in saunas and steam rooms must be stable, firm, and slip resistant and meet all applicable requirements in §302 of the standards.

*What is the door width requirement for saunas and steam rooms?*

Doors must meet all requirements of §404 and have a clear opening width of 32" minimum. There is no exception for saunas or steam rooms.

*Are windows or vision lights on doors required?*

No. But if provided, vision lights and glazing panels that permit viewing shall have the bottom of at least one panel 43" maximum above the finish floor.

*Must saunas and steam rooms be identified by the International Symbol of Accessibility (ISA)?*

Labeling accessible saunas and steam rooms with the ISA is required only where inaccessible ones are present. At least 5% of saunas and steam rooms of the same type in each cluster must comply and be identified by the ISA unless all are accessible (§213.2., Ex. 3, §216.8).

*Are rules or informational signage required?*

Information signage is not required. However, where provided, informational signs, such as rules of conduct, must comply with requirements for visual characters (§703.5). Signs are more legible for persons with low vision when characters contrast as much as possible with their background.

*If clothes hooks or shelves are provided, do they need to be accessible?*

Yes, storage elements, including clothes hooks or shelves, must comply (§225.2). At least one of each type of storage must be within reach range.

*Do controls for saunas and steam rooms need to comply with operable parts requirements?*

Yes, controls intended for users need to comply with operable parts requirements (§309). Controls must be within reach range and operable with one hand and without tight grasping, pinching, twisting of the wrist, or more than 5 lbf to operate.

*Can sauna and steam room walls be used to provide back support for benches?*

Yes, walls maybe used as back support. Where benches are provided, designs providing full back support are advisable but not required.

*Can the bench back support be tilted or must it be at a right angle to the seat?*

Bench backrests can be sloped in order to provide stability for users. Back support must be within 2.5" horizontally to the rear edge of the bench seat (§903.4).



UNITED STATES ACCESS BOARD

Advancing Full Access and Inclusion for All

1331 F Street, NW ▪ Suite 1000 ▪ Washington, DC 20004-1111  
(202) 272-0080 (v) ▪ (202) 272-0082 (TTY) ▪ [www.access-board.gov](http://www.access-board.gov)

September 2021



## U.S. Access Board Technical Guide

# Toilet Rooms

This guide explains requirements in the ADA Standards for toilet rooms.

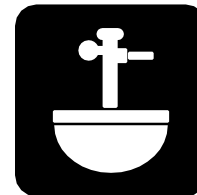

### Required Compliance [§213]

Plumbing and building codes address the number and type of toilet rooms and toilet fixtures required for a facility. The ADA Standards, on the other hand, do not address the number of toilet rooms or fixtures required for a facility, but instead specify which ones must be accessible where provided. In new construction, access is required to all toilet rooms, including those for employees. However, where single user toilet rooms are clustered in one location, at least half for each use must comply (§213.2., Ex. 4). In the case of single user portable units, access is required to at least 5% at each cluster, excluding those on construction sites for construction personnel which are fully exempt (§213.2, Ex. 3, §203.2).

### Clustered Single User Toilet Rooms

*Clustered single user toilet rooms (2 minimum) are those that are next to, or close to, one another. No more than 50% for each use within a cluster must comply. Compliant toilet rooms and portable units must be labeled by the International Symbol of Accessibility unless all are accessible (§213.2, Ex. 3, §216.8).*



## Unisex (Single-Use or Family) Toilet Rooms [§213.2]



Where multi-user toilet rooms are provided, accessible unisex toilet rooms cannot serve as a substitute for access to multi-user rooms, except in alterations where making multi-user rooms comply is not technically feasible (§213.2, Ex. 1). Otherwise, where multi-user and unisex restrooms are provided, both types must comply. Providing an accessible unisex toilet room in addition to multi-user toilet rooms is helpful for those who use personal care assistants of the opposite sex. The International Building Code (IBC) requires accessible unisex or “family” toilet rooms in assembly and mercantile occupancies where a total of six or more toilet fixtures for each sex is required (§1108.2.1 in the 2000 IBC and §1109.2.1 in later editions). The ADA Standards require that unisex toilet rooms, where provided, have privacy latches and contain at most one lavatory, one water closet, and one urinal (or a second water closet) (§213.2.1).

## Medical Care and Long-Term Care Facilities [§223.1, §805.4]



In licensed medical care and long-term care facilities, toilet rooms that are part of accessible patient or resident sleeping rooms, excluding critical or intensive care patient sleeping rooms, must comply (§223.1, Ex., §805.4). The Standards cover independent accessibility and do not address design for use that is assisted by medical or resident care personnel. Features for assisted use that conflict with the Standards can be provided in those toilet rooms serving rooms not required to comply with the Standards. Otherwise any departure from the Standards must be based on the provision for “equivalent facilitation” (§103) which permits alternatives to specified requirements that provide substantially equivalent or greater accessibility and usability. This means that the alternative solution is just as, if not more, effective than what is required by the Standards in terms of accessibility, usability, convenience, and reliability for people with disabilities.

### Toilet Room Location

The Standards specify the location of toilet rooms in two instances:

- Where toilet rooms are provided in multi-story facilities that are exempt from the requirement for vertical access between stories (§206.2.3, Ex. 1 or 2), a toilet room must be provided on a story that is connected to an accessible entrance by an accessible route (§213.1). Toilet rooms on other stories must fully comply as well.
- In alterations where it is technically infeasible to make men’s and women’s rooms comply, an accessible unisex toilet room is permitted as an alternative if it is located in the same area and on the same floor as the existing toilet rooms (§213.2, Ex. 1).

## Additions [§202.2]

Additions are required to comply with requirements in the Standards for new construction. Each toilet room of an addition must comply as would be required in new construction.

## Alterations [§202.3]

When existing toilet rooms are altered, the Standards apply according to the planned scope of work. If one toilet room on a floor is altered, the Standards apply to that room only; if all toilet rooms on a floor are altered, the Standards apply to each toilet room that would be required to comply in new construction. The scope of work also determines which technical requirements apply. If some, but not all, elements in a toilet room are altered, only those elements altered must comply. If a room or space is completely altered (or built new as part of an alteration), the entire room or space must comply.

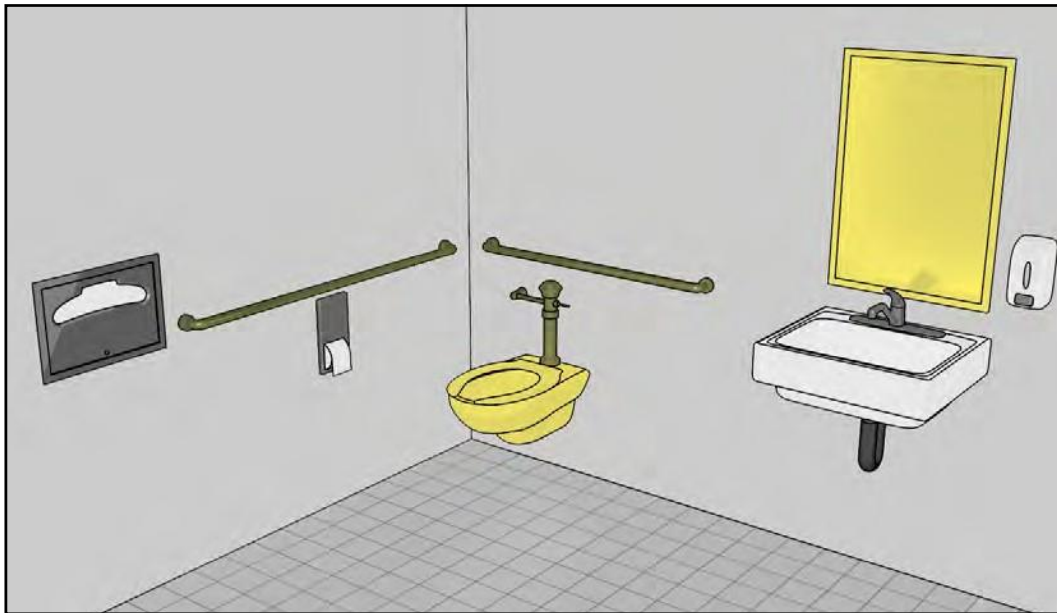

*In a project involving alterations to the toilet, grab bars, faucet controls, and mirror in a restroom, the Standards apply to these elements but not to those that remain unaltered.*

*In more extensive projects where additional elements are altered, application of the Standards is greater, commensurate with the scope of work.*



**Recommendation:** While only those elements altered are required to comply, it is advisable to maximize opportunities for accessibility in alterations. Alteration of multiple elements in a room or space may provide a cost-effective opportunity to make the entire room or space fully accessible.



Compliance in an alteration is not required where it is “technically infeasible.” The term is defined as “something that has little likelihood of being accomplished because existing structural conditions would require removing or altering a load-bearing member that is an essential part of the structural frame; or because other existing physical or site constraints prohibit modification or addition of elements, spaces, or features that are in full and strict compliance with the minimum requirements.” For example, combining two toilet compartments to create an accessible compartment may be technically infeasible where it would reduce the fixture count below the number required by the applicable plumbing code.

When it is technically infeasible to make existing men’s and women’s rooms comply, an accessible unisex toilet room can be provided instead if it is in the same area and on the same floor as the existing toilet rooms (§213.2, Ex. 1). Where technical infeasibility is encountered, compliance is still required to the maximum extent feasible.

### **Alterations and Additions to Primary Function Areas [§202.4]**

When an area containing a primary function (a major activity intended for a facility) is altered or added to a facility, an “accessible path of travel” is required. The accessible path of travel, which must extend from site arrival points to the primary function area, includes provided restrooms (at least one for each sex or, if only unisex restrooms are provided, at least one unisex restroom), telephones, and drinking fountains, where provided, that serve the primary function area. The accessible path of travel is required to the extent that it does not cost more than 20% of the total cost of the work to the primary function area. Compliance is required up to the point this cost cap is reached, even where it does not result in a fully accessible path of travel. See the Alterations and Additions Guide.

### **Alterations to Qualified Historic Facilities [§202.5, §213]**

The Standards provide certain exceptions for qualified historic facilities where compliance in an alteration would threaten or destroy the historic integrity or significance of a facility as determined by the appropriate State Historic Preservation Official or Advisory Council on Historic Preservation. One of these exceptions allows access to be provided to a unisex toilet room or to one men’s and one women’s room regardless of the number of toilet rooms altered or added (§213.2, Ex. 2).



This guide notes some provisions in the International Building Code (IBC) and the *ICC A117.1 Standards for Accessible and Usable Buildings and Facilities* that are not found in the ADA Standards. For example, the A117.1 standard, which provides technical provisions and is referenced by the IBC, requires a vertical grab bar at water closets. Not all differences between the ADA Standards and editions of the IBC and A117.1 standard are noted in this guide.

### Components of Accessible Single User Toilet Room

Requirements in the Standards for toilet rooms address doors, turning space, plumbing fixtures, mirrors, dispensers, shelves, and other elements provided. Other provisions in the Standards also apply.

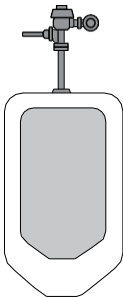
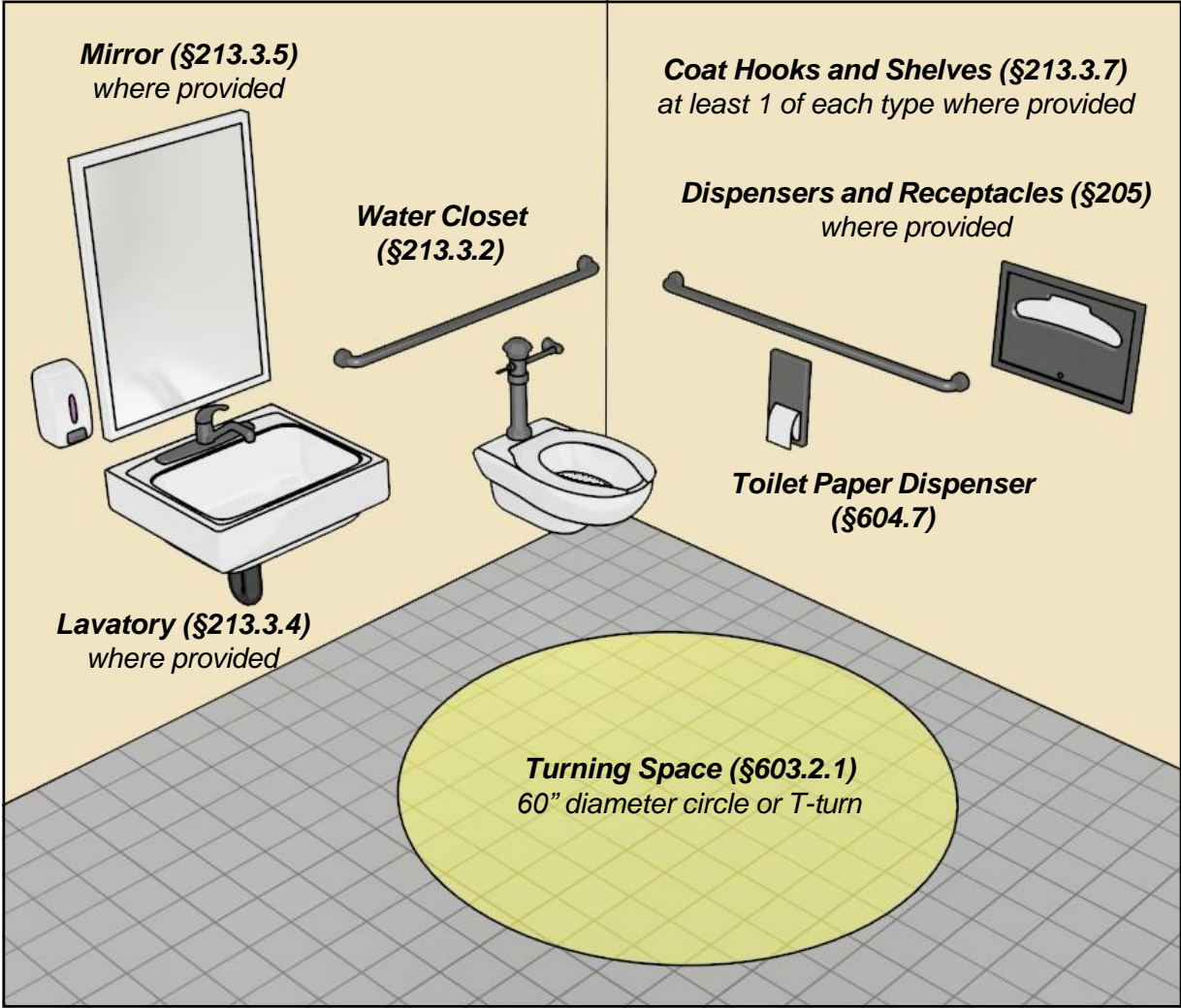

**Urinals (§213.3.3)**  
An accessible urinal is required only in toilet rooms where more than one urinal is provided.

## Water Closets [§213.3.2, §604]

Criteria for water closets address location, clearance, seats, grab bars, flush controls, and dispensers. Water closets can be arranged for either a left-hand or right-hand approach.

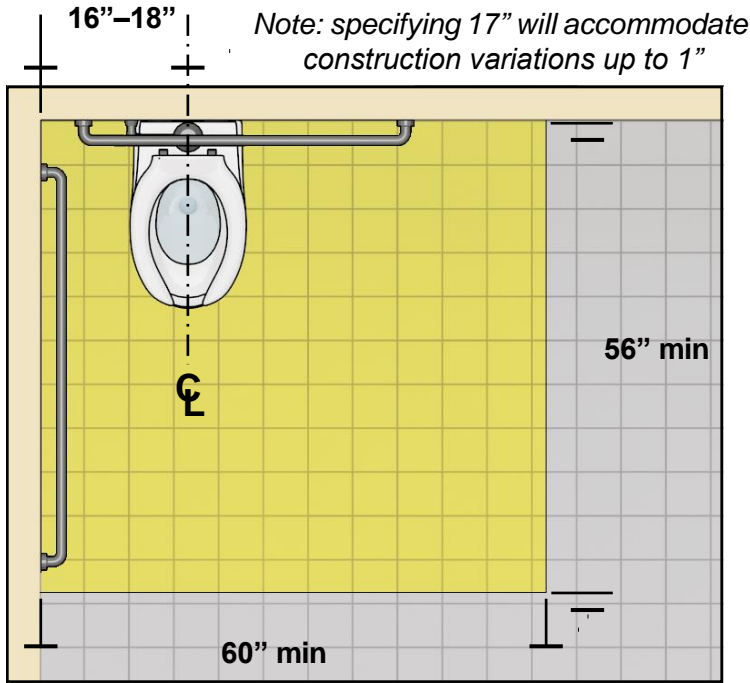

The required clearance provides space for approach and transfer to water closets. The water closet, associated grab bars, toilet paper dispensers, seat cover and other dispensers, coat hooks, shelves, and sanitary napkin disposal units are the only elements that can overlap this clearance (§604.3.2). Other elements and fixtures cannot overlap the required water closet clearance. (In residential dwelling units, a lavatory can overlap a portion of the water closet clearance under certain conditions.)

### Location, Clearance, Seat Height and Flush Controls

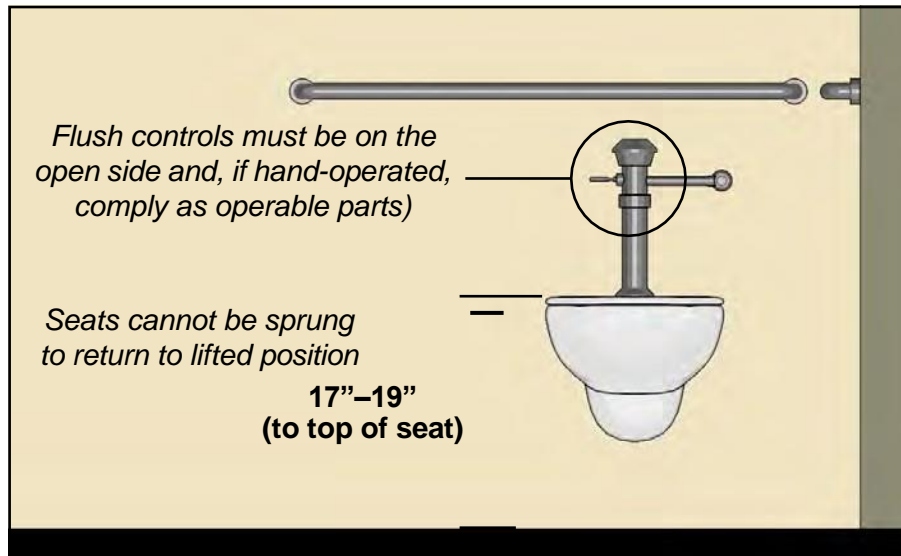

**Recommendation:** Locate flush valves and related plumbing to the side of the water closet or behind walls to keep the rear grab bar clear.

### Grab Bars [§604.5, §609]

Grab bars are required to be mounted on the walls beside and behind the water closet. They can be separate or continuous. When returned to walls, the length is measured to the centerline of the return, consistent with industry practice. When attached at other points along the bar, the length is measured to the end of the bar.

Rear Grab Bar

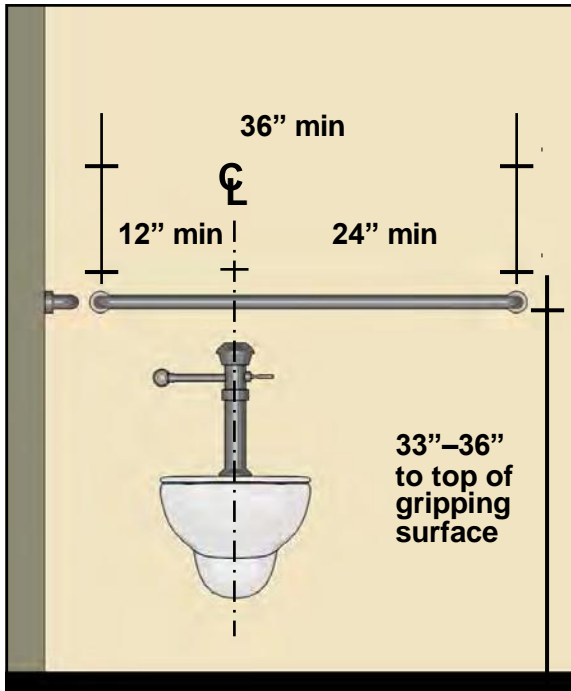

Side Grab Bar

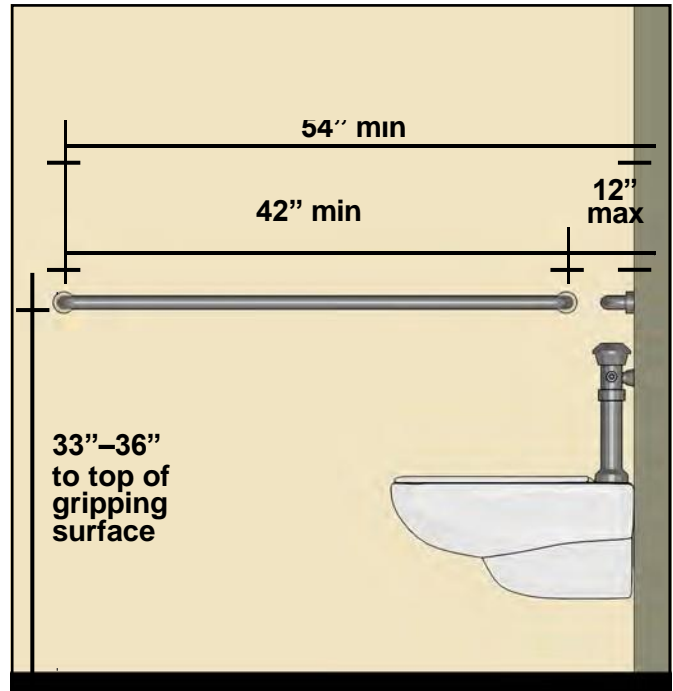

*The rear grab bar can be shifted to the open side of the water closet or split where it would conflict with the location of flush controls required by applicable codes (§604.5.2).*

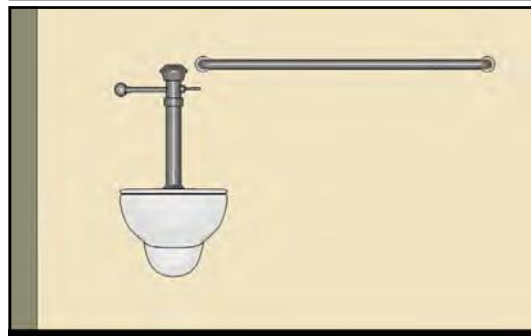
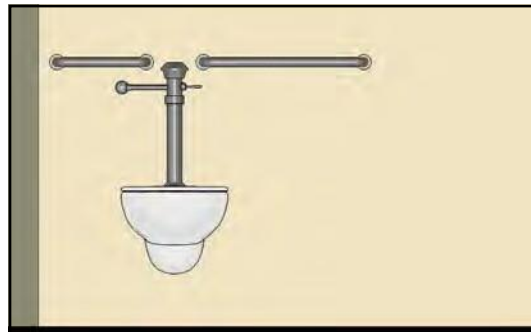

Grab bars and wall or other surfaces adjacent to them must be free of abrasive or sharp elements. Any projecting object must be located at least 12" above grab bars and at least 1½" from the bottom and ends of grab bars so that the reach and use of grab bars is not impeded.

**Minimum Clearances at Grab Bars**

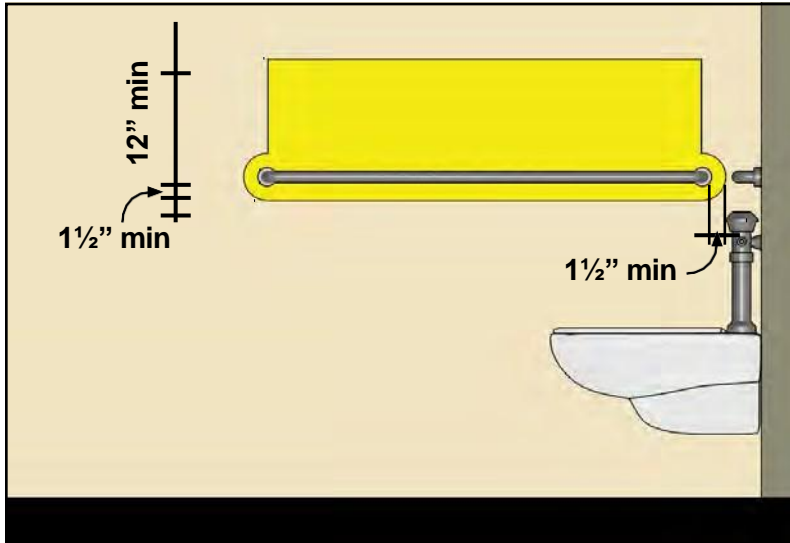

Grab bars can have circular or non-circular cross-sections but must have rounded edges. The 1½" clearance between the grab bar and wall is not a minimum but an absolute dimension to prevent entrapment. Grab bars cannot rotate within fittings. The structural strength of grab bars must withstand a vertical or horizontal force of 250 lbs. at any point on the grab bar, fastener, mounting device, or supporting structure.

**Cross Section and Clearance**

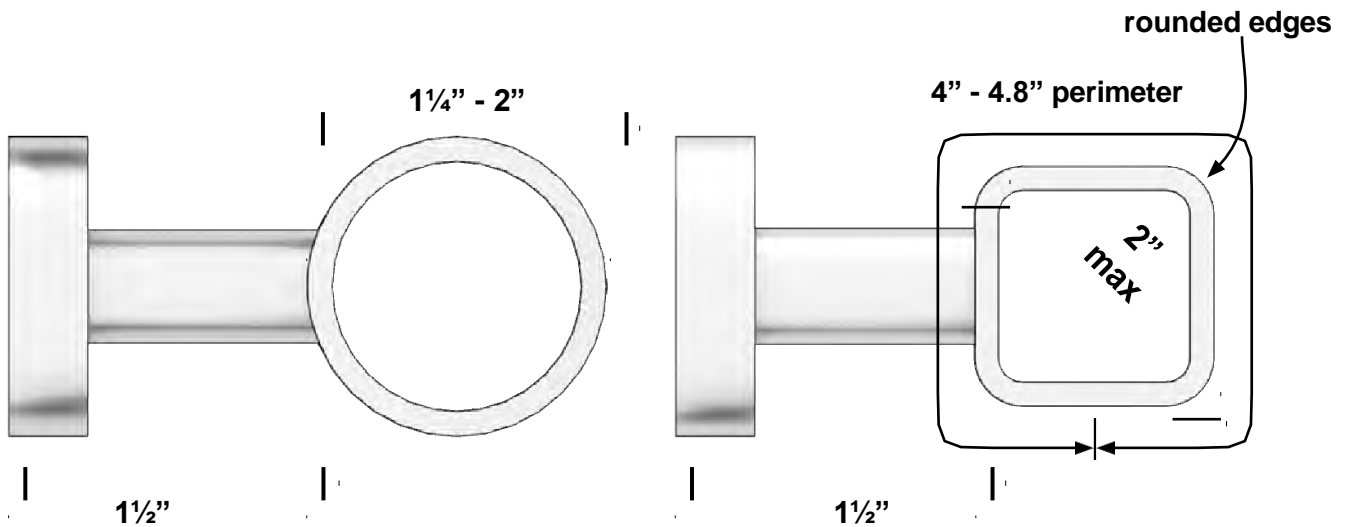

The Standards do not require or address additional folding or swing-away grab bars on the open side of the water closet. However, if provided, they must be mounted so that they do not interfere with use of the required grab bars or the clear floor space at water closets. Also, it is important they are properly secured (although this is not addressed by the Standards).

### Vertical Grab Bar (ICC A117.1 Standard)

The *ICC A117.1 Standard for Accessible and Usable Buildings and Facilities*, which is referenced by the International Building Code, requires an 18" min. vertical grab bar at water closets. The ADA Standards do not require this grab bar but allow a second grab bar to be within the 12" clearance above the horizontal grab bar (§609.3) if there is a separation of 1½" min.

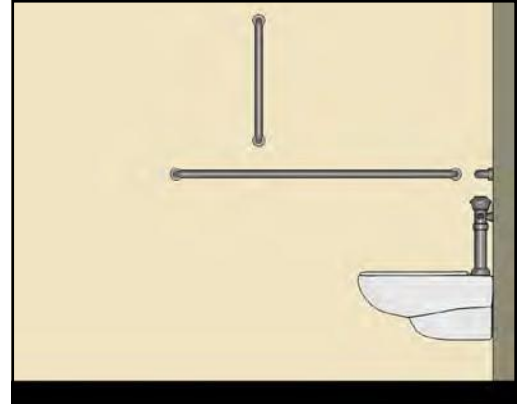

### Toilet Paper Dispensers [§604.7]

Toilet paper dispensers must be within accessible reach from the water closet. They can be located below or above (but not behind) grab bars, though it is important that non-recessed dispensers be outside the 12" minimum high clearance above the bar yet not exceed the 48" maximum height (measured to the outlet) of the dispenser. Dispensers must allow continuous paper flow and cannot control delivery.



*Recommendations:* Recessed toilet paper dispensers provide better access by keeping space at the water closet clear. Large-roll dispensers can obstruct space at water closets and can be hard to reach due to their width and the required placement from the water closet measured to the dispenser centerline.

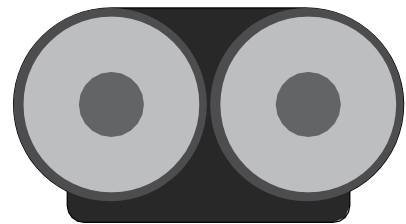

## Recessed Dispenser Location

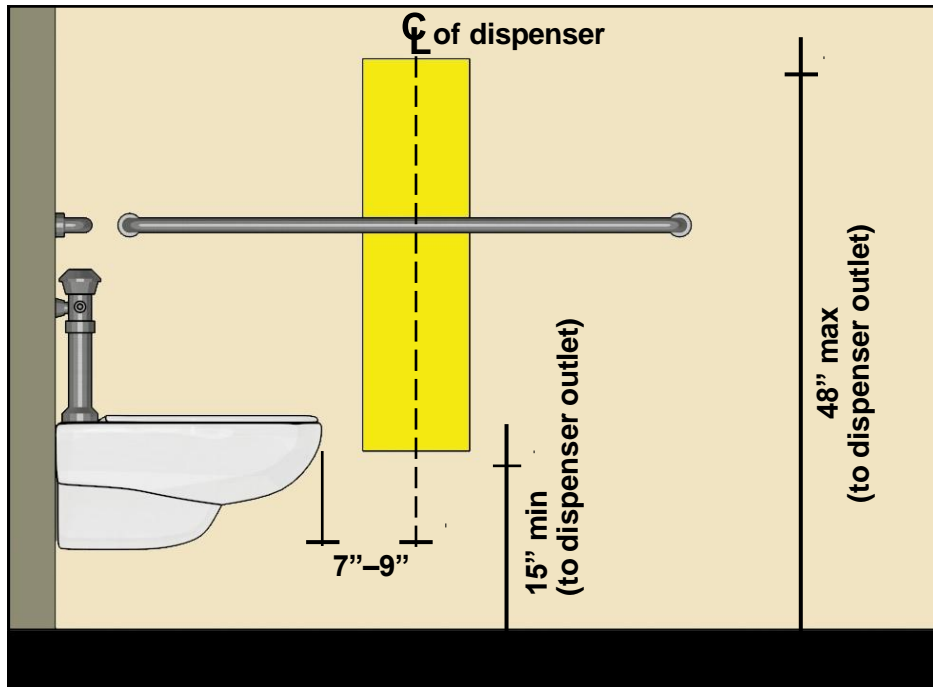

## Non-Recessed Dispenser Location

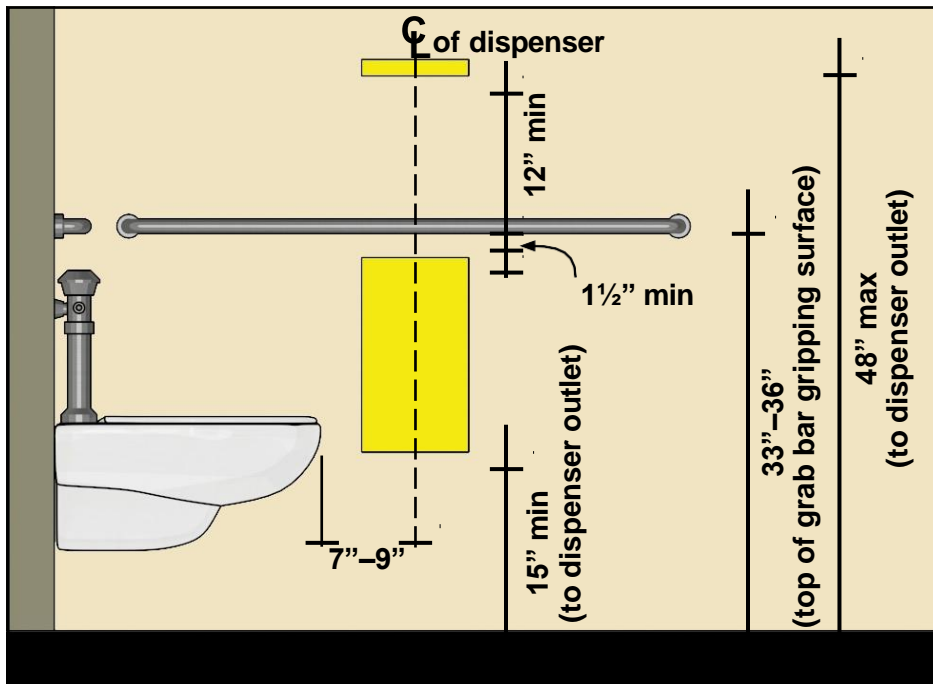

*If the grab bar is 36" high, a non-recessed toilet paper dispenser located above the bar must have an outlet at exactly 48" high to accommodate both the max. reach height and the 12" min. clearance above the grab bar.*

## Example Single User Toilet Room

The Standards do not directly specify the size of toilet rooms which is determined by a variety of factors, including the layout and number of fixtures, the presence of other features, such as baby changing tables, and even the swing of doors. How various space requirements are met also determine the minimum room size, including required clearances at fixtures and other elements, turning space, and door maneuvering clearance.

Accessible toilet rooms can be configured in many different ways. The layout shown here is used only as an example in illustrating the features of a compliant toilet room. These designs show the minimum dimensions specified in the Standards. Providing additional space in toilet rooms will enhance usability.

**Water Closet Clearance**

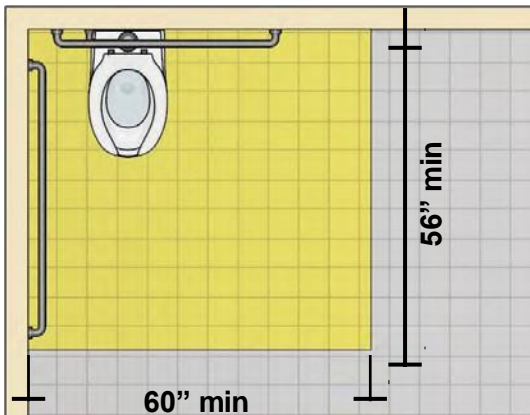

*Water closets can be placed in any corner.*

**Lavatory Clearance**

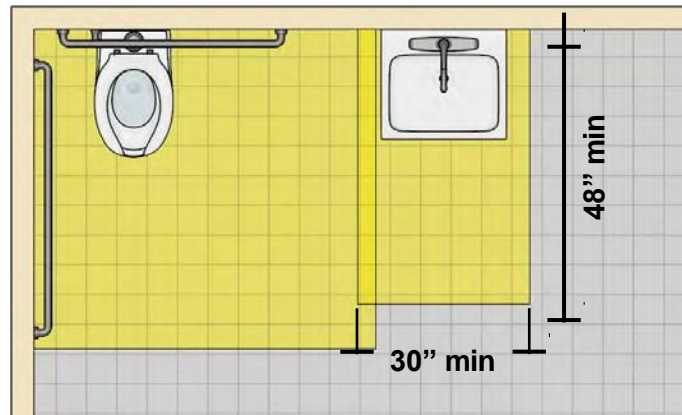

*The lavatory cannot overlap the water closet clearance (except in residential dwelling units), but the clearance at the lavatory can. It is advisable (but not required) to nominally center the lavatory on the clear floor space.*

### Option: Recessed Lavatory

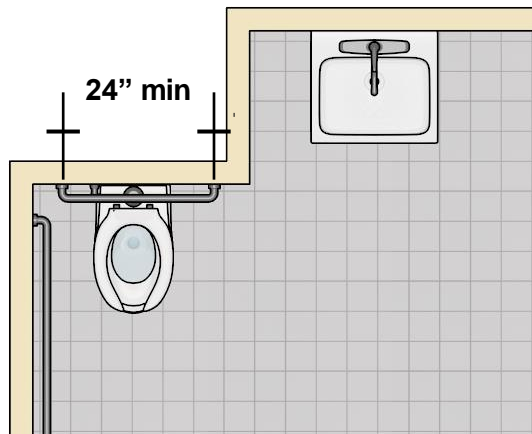

*If a lavatory or other fixture is recessed next to a water closet, the rear grab bar can be 24" (instead of 36") long minimum, centered on the unit if wall space does not allow a grab bar 36" long min. (§604.5.2).*

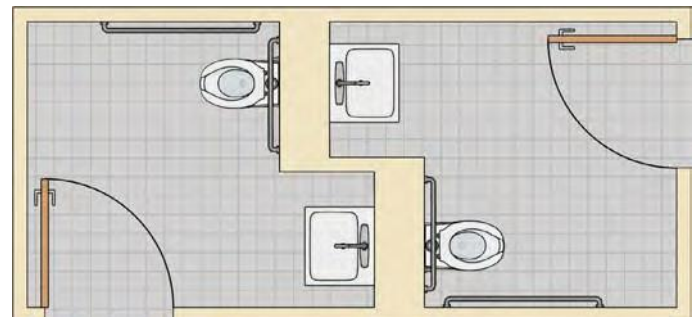

*Recessed fixtures can save space where two rooms are paired.*



## Doors [§404]

Maneuvering clearance is required at doors based on the approach and swing. No elements can overlap door maneuvering clearances.

**Push-Side Maneuvering Clearance**

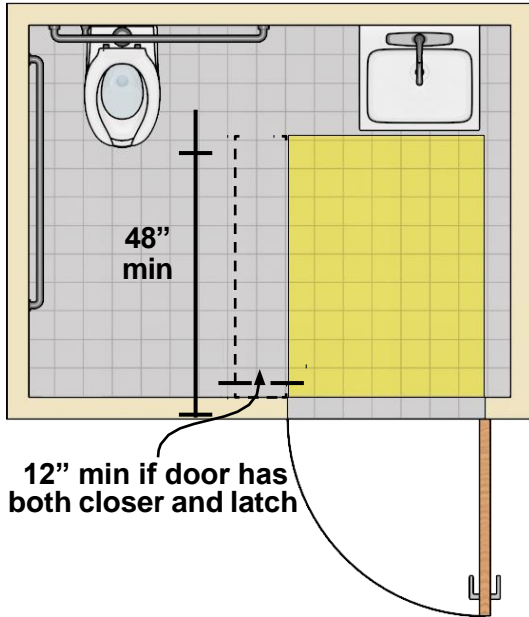

**Pull-Side Maneuvering Clearance**

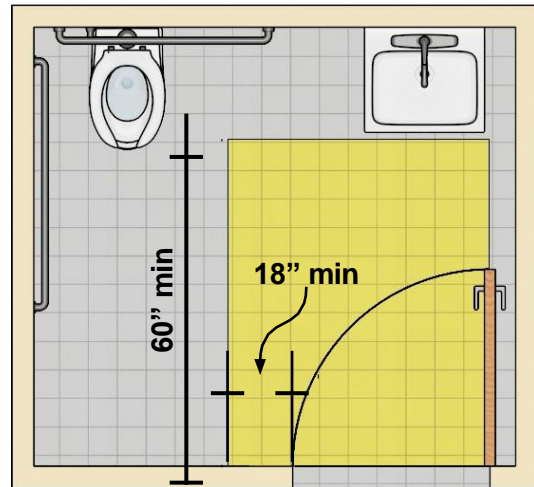

Doors can swing into fixture clearances in single-user toilet rooms where unobstructed wheelchair space is available beyond the door swing (603.2.3). This provides space to enter the room and clear the door using wheeled mobility aids.

**Door Swing Outside Fixture Clearances**

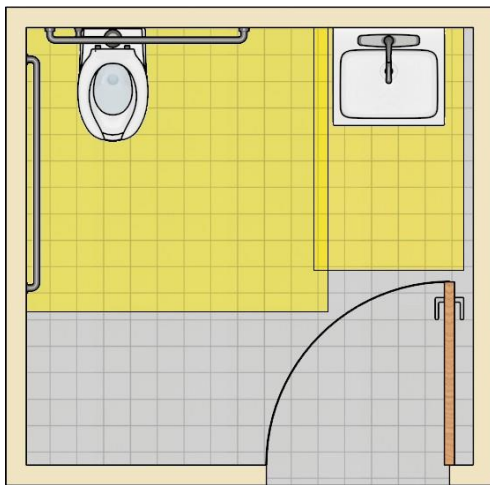

**Wheelchair Space Beyond Door Swing**

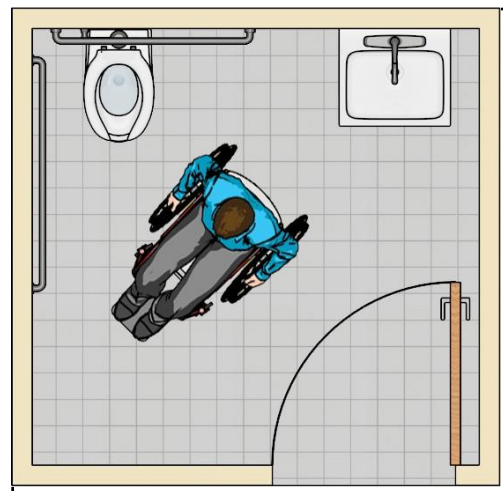

*The location and orientation of the wheelchair space is not specified, but it should be easy to access upon entry into the room.*

## Turning Space [§304, §603.2.1]

Turning space is required in the room and can be provided as a 60" diameter circle or T-shaped space. Doors can swing into the turning space. The orientation of the T-shaped space is not specified, and it can be located for approach at any segment (i.e., the stem or either arm).

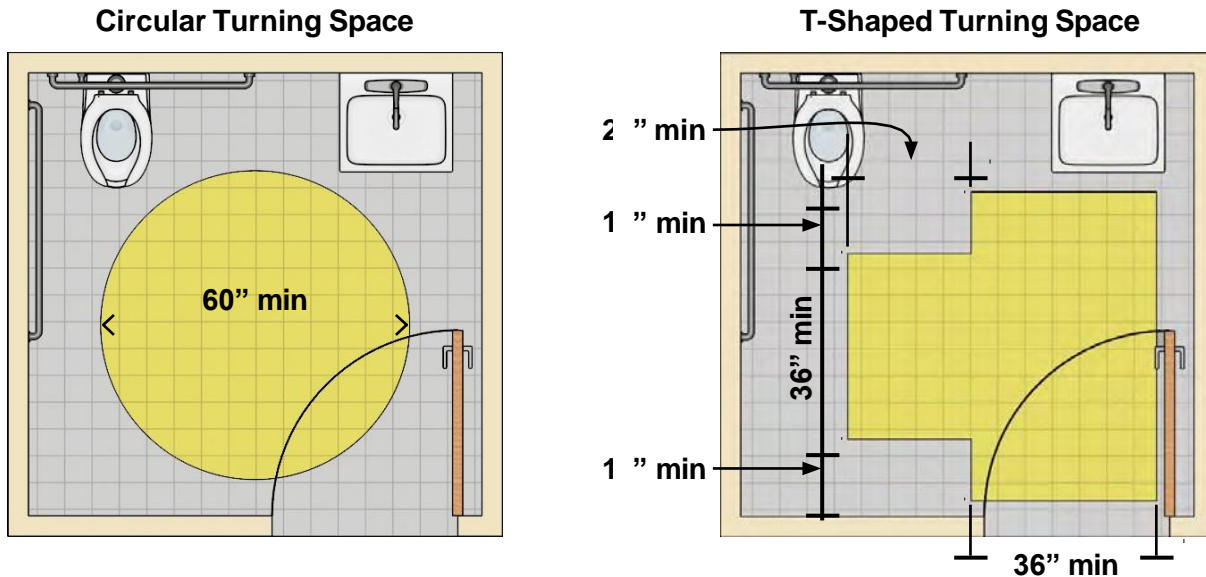

Elements with knee and toe clearance can overlap a portion of the turning space. With t-shaped space, overlap is limited to one segment of the T so that the other two remain clear for approach and backing up.

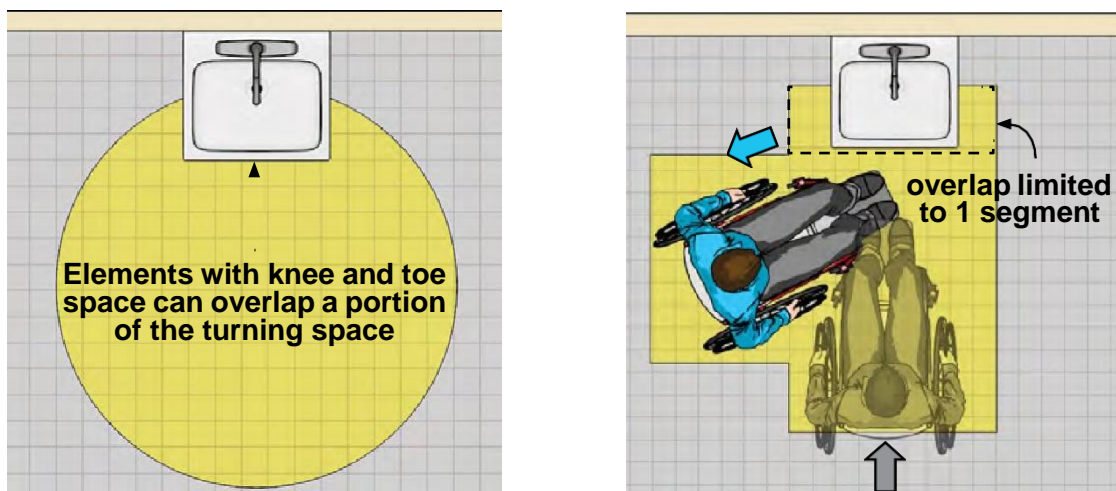

**Recommendation:** To provide easier access, locate elements with knee and toe space outside the turning space.

## Approximate Room Dimensions

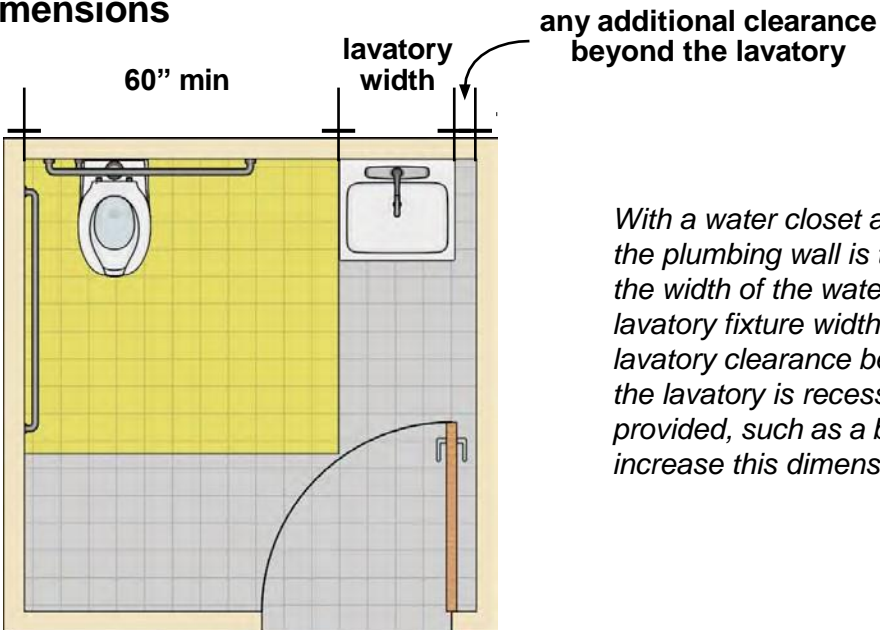

*With a water closet and lavatory side-by-side, the plumbing wall is typically determined by the width of the water closet clearance, the lavatory fixture width, plus any additional lavatory clearance beyond the fixture (unless the lavatory is recessed). Other elements provided, such as a baby changing table, may increase this dimension.*

*In the same example, if the door is opposite the plumbing wall and swings in, the room depth will likely be determined by keeping the door swing outside fixture clearances (left). Alternatively, if there is unobstructed wheelchair space beyond the door swing, the door maneuvering clearance and the horizontal depth of the lavatory may determine the room depth (right). Turning space is typically available in the room without further increase in room size where doors swing in.*

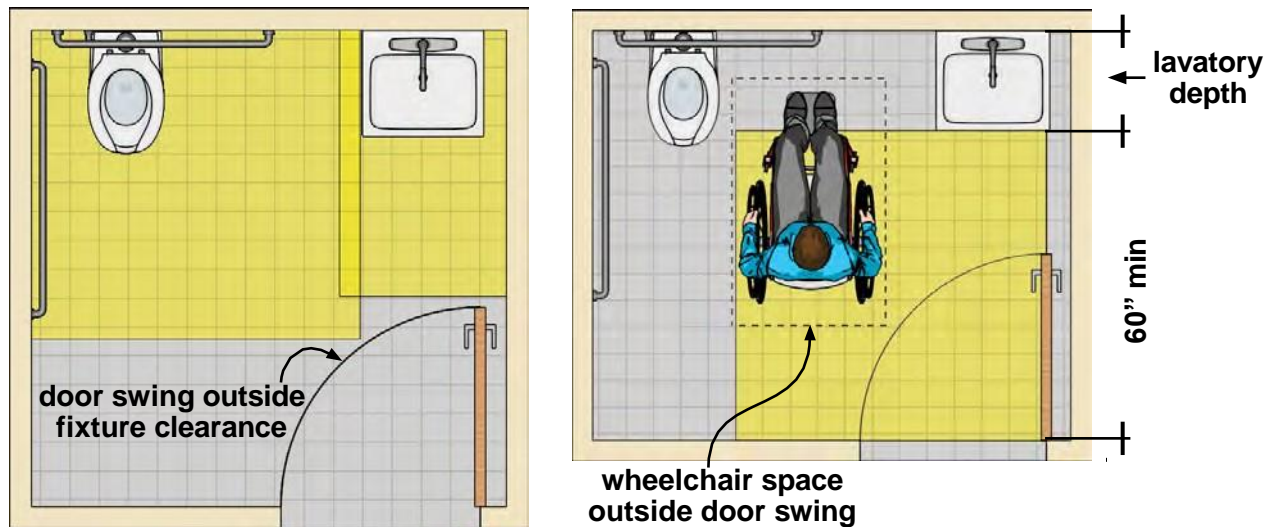

*Note: Other elements provided may increase minimum room dimensions.*

If the door swings out, the room depth is usually determined by the door maneuvering clearance and the horizontal depth of the lavatory. Turning space usually can be provided without further increase in this design but providing additional depth will help minimize fixture overlap of the turning space for improved access.

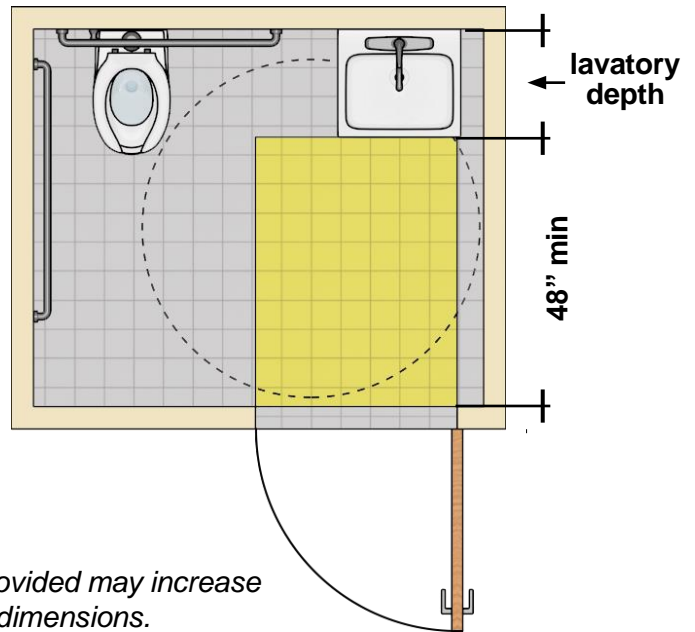

Note: Other elements provided may increase minimum room dimensions.

### Example: Lavatory Opposite Water Closet

Toilet rooms can be configured in many different ways, but the same requirements apply, including those for fixtures, doors, and turning space. This example shows a door swing located outside fixture clearances (obviating the need for wheelchair space beyond the arc of the door swing) and turning space free of any overlapping elements (left). Fixtures and other elements can overlap turning space but not the door maneuvering clearance (right).

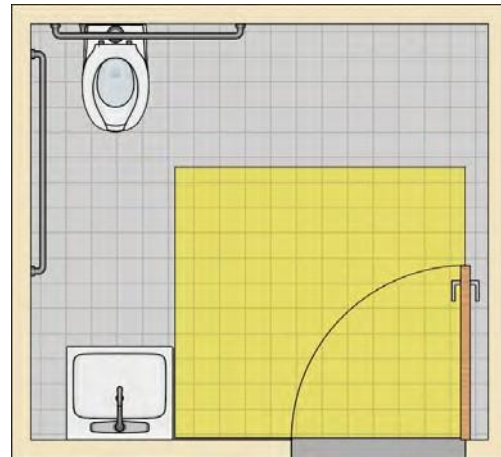
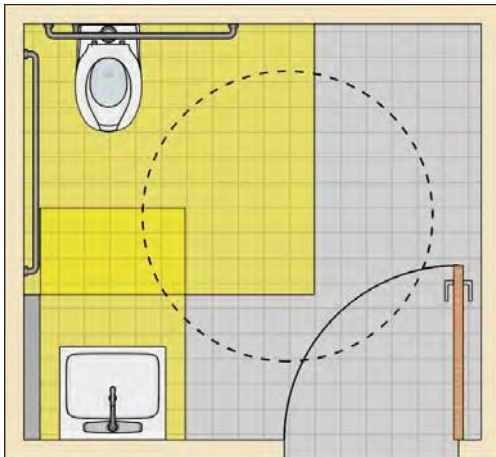

**Recommendation:** Toilet rooms sized to provide more space than the minimum required by the Standards improve access and enhance usability particularly for people using wheelchairs by allowing more room for maneuvering, transfers, and turning.

## Dispensers and Receptacles [§205, §309], Coat Hooks and Shelves [§213.3.7, §603.4]

Dispensers, receptacles, and other operable parts, as well as shelves and coat hooks, must comply where provided.

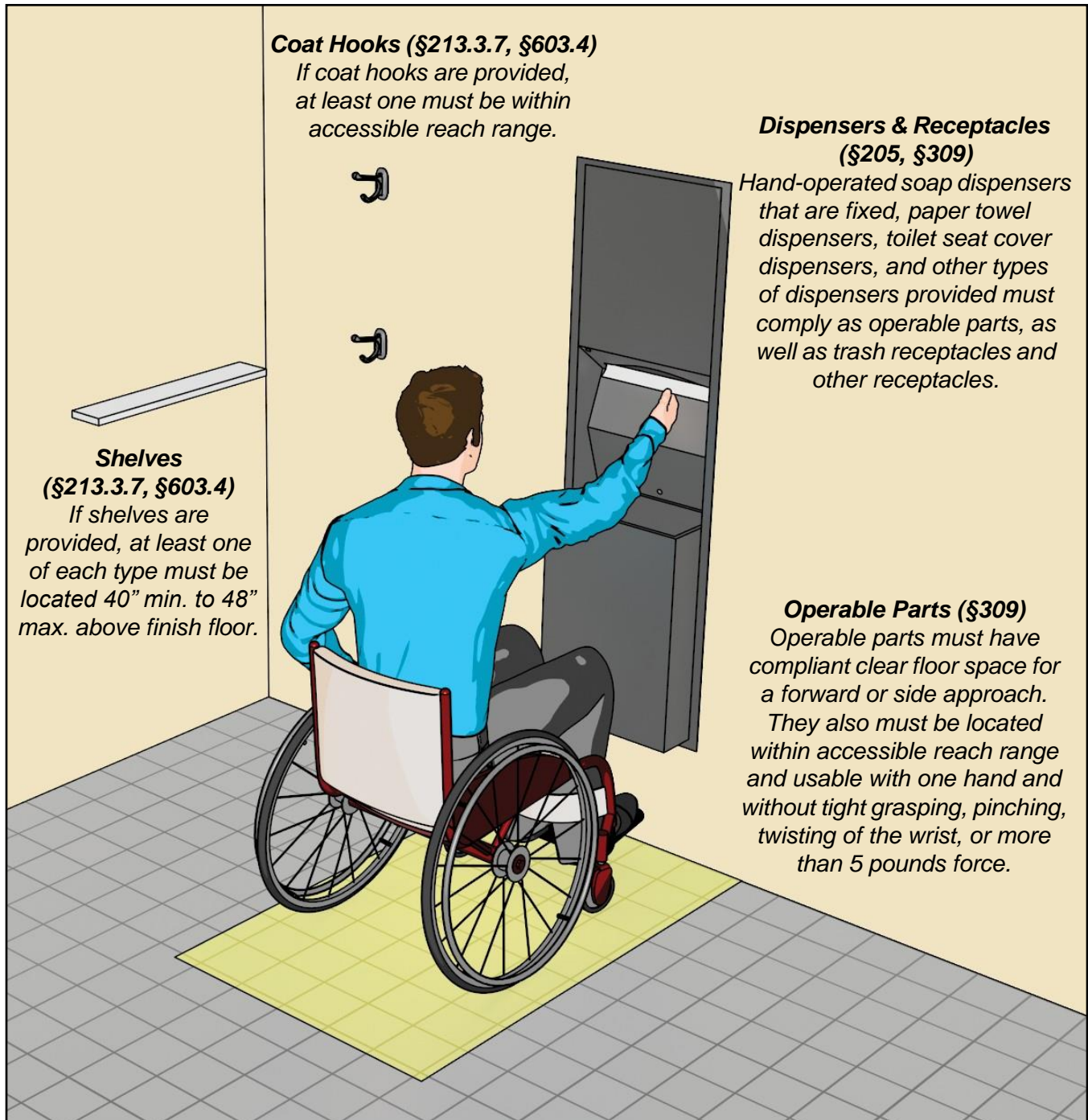

## Baby Changing Tables [§226, §902]

Where baby changing tables are provided, they must comply as a work surface and, if they project into circulation paths, as protruding objects.

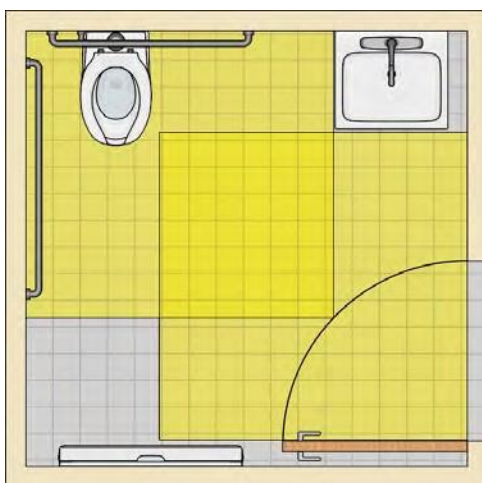
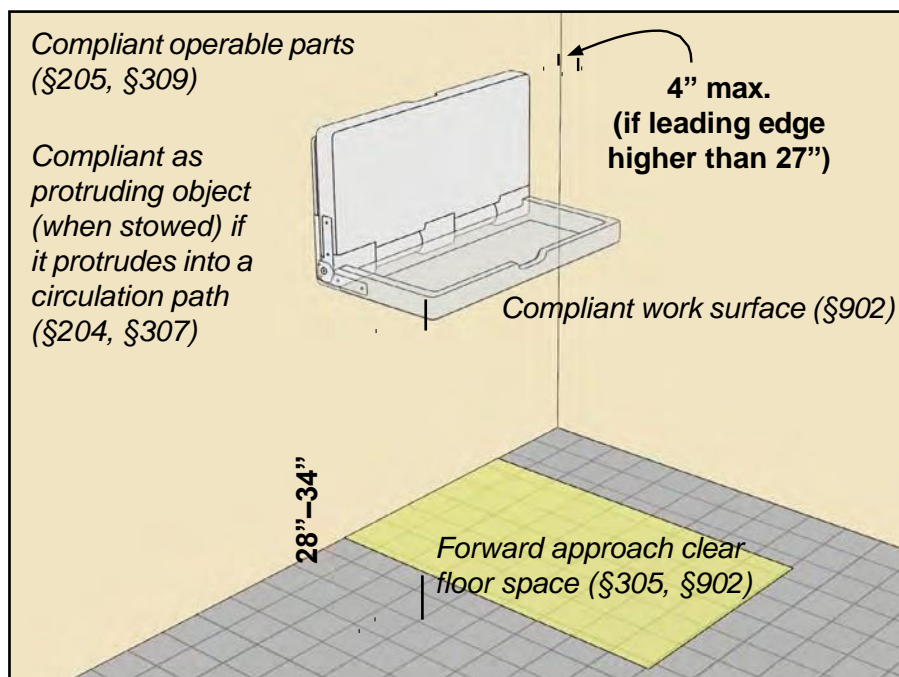

*Baby changing tables cannot overlap fixture clearances or door maneuvering clearances when stowed.*

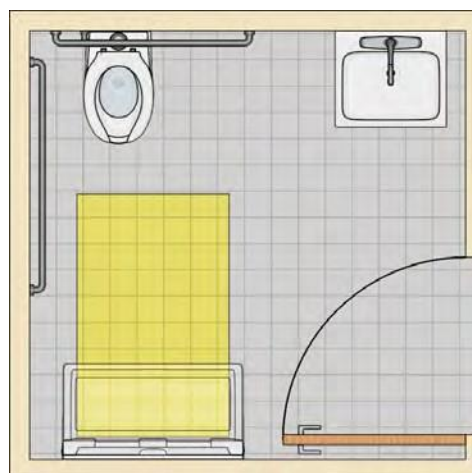

*Clear space for a forward approach to the table is required. This space can overlap fixture clearances and door maneuvering clearances.*



**Recommendations:** Locate baby changing tables so that they are easy to use by people with disabilities. Avoid placement in toilet compartments for easier access.

## Private Toilet Rooms Accessed through a Private Office

Single-occupant toilet rooms accessed only through a private office and not for common or public use are permitted exceptions that allow certain access features, such as grab bars, to be provided after construction as needed. However, they still must be sized for accessibility and fully meet all space requirements. Enlarging or reconfiguring a private toilet room is not permitted by the Standards as a post-construction accommodation.

### Exceptions for Private Toilet Rooms

*Note: All other applicable requirements, including clearances and turning space, must be met.*

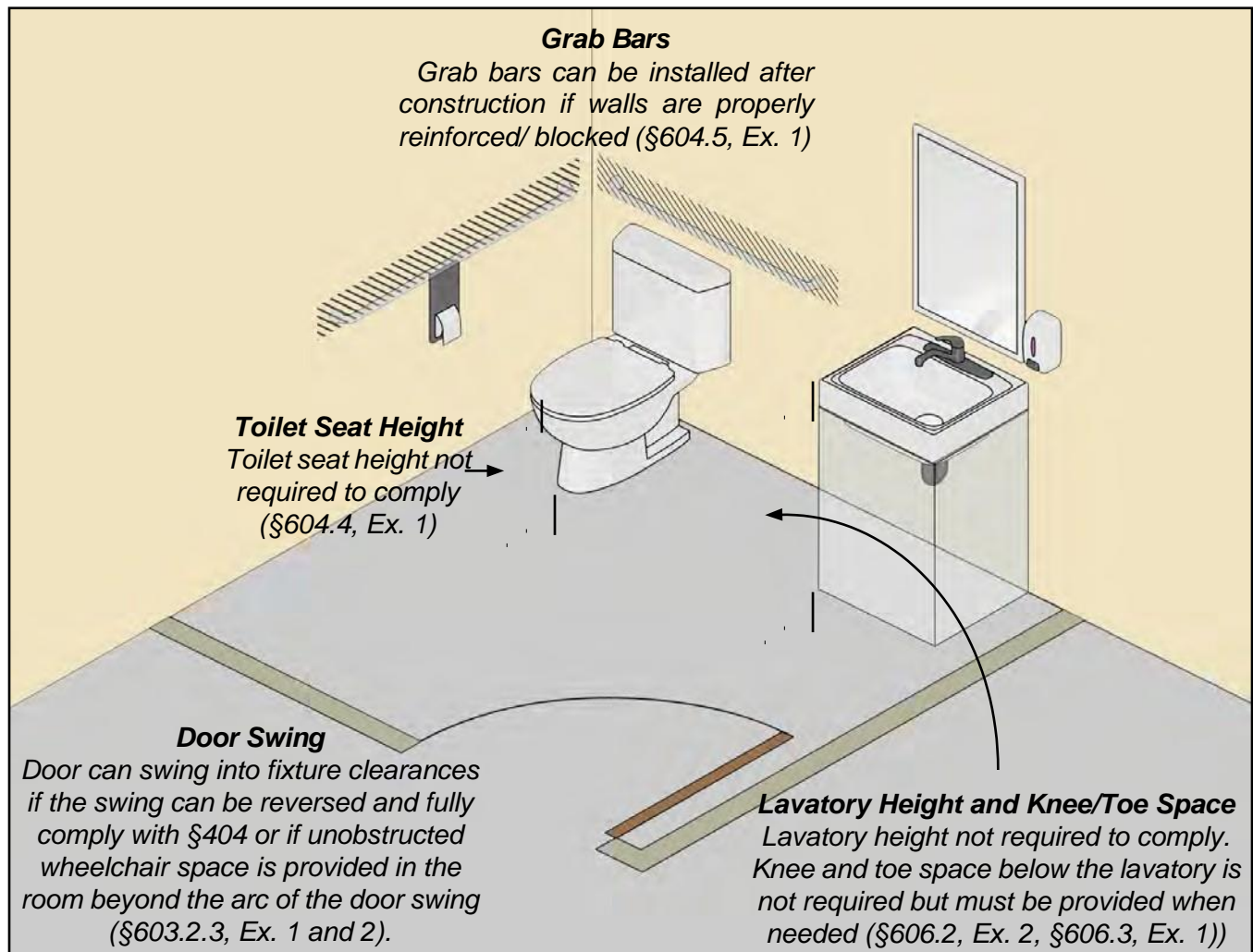

**Recommendations:** Cabinetry below lavatories should be readily removable with finish floor below and finished walls behind it. Verify that the applicable building or life safety codes will permit the door swing to be reversed if using the exception for doors.

## Water Closets in Residential Dwelling Units

In residential dwelling units required to be mobility accessible, at least one bathroom must comply (§809.4). Accessible water closets in dwelling units are permitted several exceptions that allow some features, such as grab bars and knee and toe space below lavatories, to be provided after construction as needed if certain conditions are met. In addition, lavatories can overlap a portion of the water closet clearance if additional clearance depth is provided.

### Exceptions for Water Closets in Dwelling Units

*Note: All other applicable requirements, including clearances and turning space, must be met.*

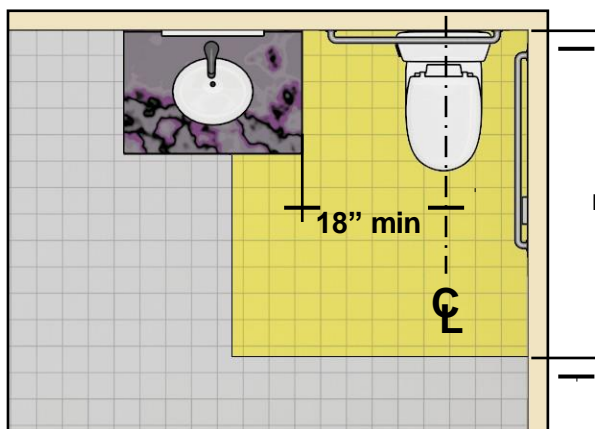
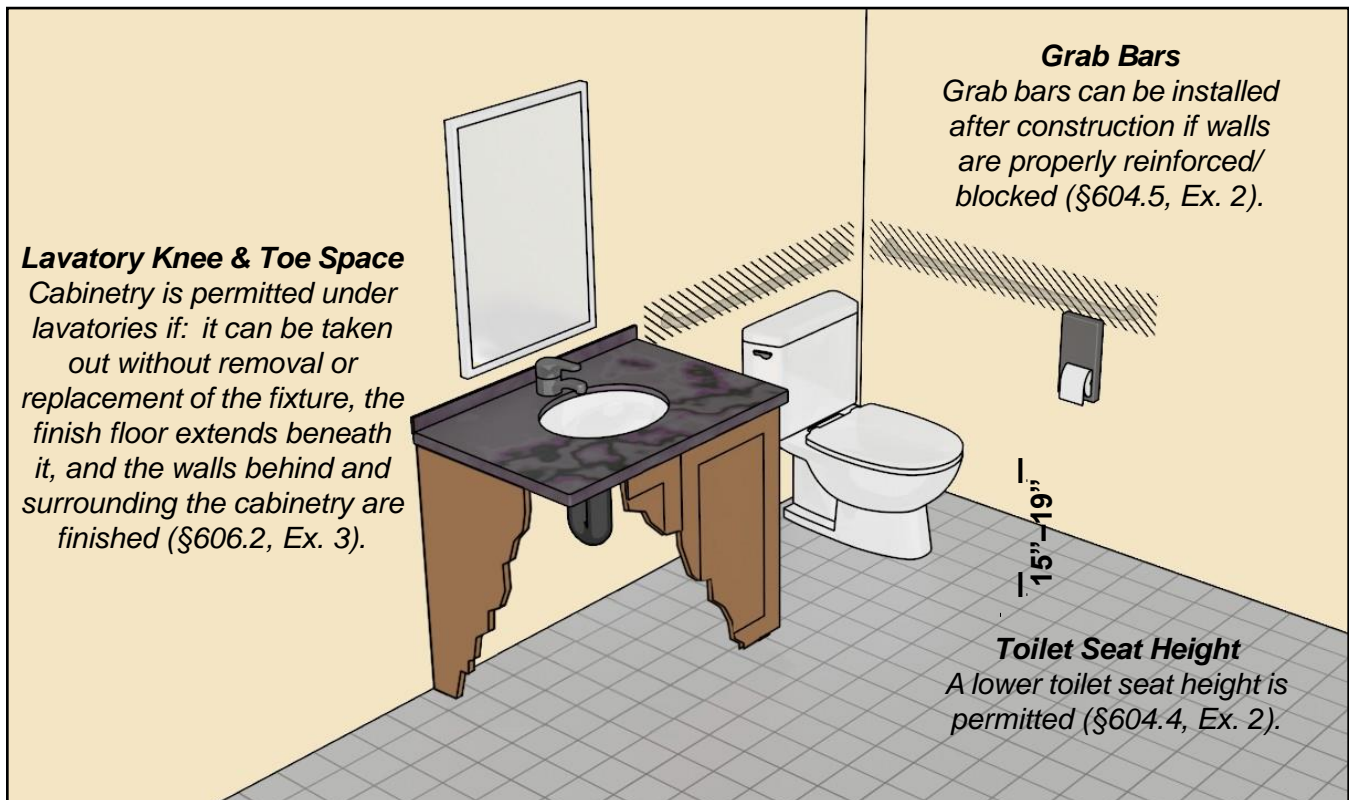

A compliant lavatory is permitted on the rear wall 18" min. from the water closet centerline if the clearance at the water closet is at least 66" (instead of 56") deep (§604.3.2, Ex.).



### Dwelling Unit Water Closet and Lavatory

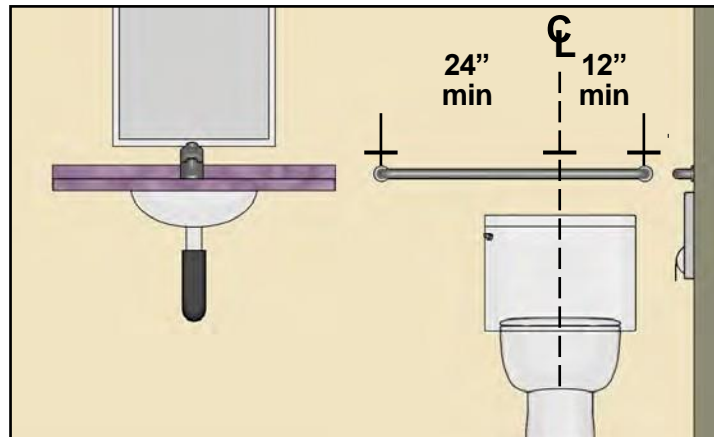

*Recommendations:* Keep the lavatory outside the water closet clearance so that space is available for side transfers. Lavatories that overlap the water closet clearance should be located so that the rear grab bar does not overlap the lavatory or counter.

### Water Closets and Toilet Compartments for Children's Use [§604.1, §604.8, §604.9]

Specifications based on children's dimensions can be followed when water closets and toilet compartments are designed primarily for use by children ages 12 and younger. Structured as exceptions, these provisions are optional and serve as alternatives to adult-based dimensions. Under the Standards, the decision to design a toilet room for children is left to other building requirements or regulations, good practice, client preference, or other factors. When a toilet room or compartment is designed for children, all pertinent alternate specifications for toilets, compartments, grab bars, and dispensers must be applied.



*Recommendations:* Where a toilet room serves both adults and children, provide one wheelchair accessible toilet for adults and a second one for children (only one toilet or compartment is required to be accessible in a toilet room). Unisex or "family" restrooms that are provided in addition to multi-user toilet rooms are beneficial to parents with children of the opposite sex.

The Standards provide non-mandatory guidance on specifications according to the age group served that reflect the differences in size, stature, and reach ranges of children ages 3 through 12. The chosen specifications should correspond to the primary user group and be consistent within an age bracket. If the planned user group spans more than one age group, one can select specifications that align on the borderline between the two groups.

### Water Closet for Children 12 and Younger

*Note: All other requirements for children’s water closets and toilet compartments are consistent with those based on adult dimensions.*

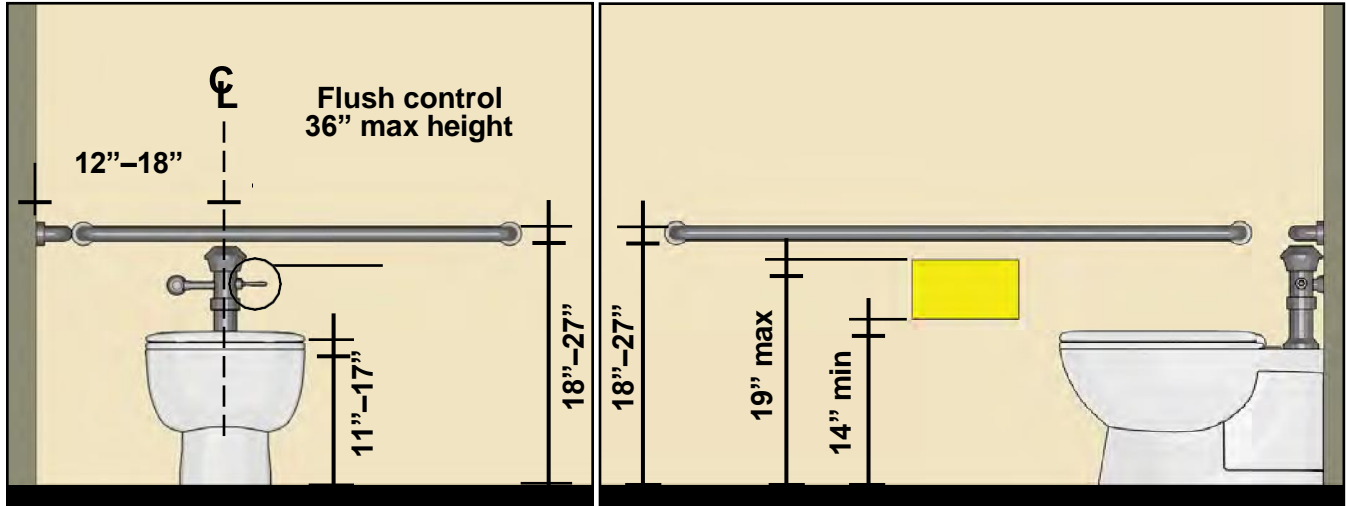

*Water closet centerline, seat height, and grab bar height*

*Grab bar and toilet paper dispenser height*

The rear grab bar can be shifted to the open side of the water closet or split where it would conflict with the location of flush controls required by the applicable code (§604.5.2, Ex. 2).

<b>Advisory (Non-Mandatory) Specifications by Age Group</b>			
	<b>3 &amp; 4</b>	<b>5 through 8</b>	<b>9 through 12</b>
Water Closet Centerline	12"	12" – 15"	15" – 18"
Toilet Seat Height	11" – 12"	12" – 15"	15" – 17"
Grab Bar Height	18" – 20"	20" – 25"	25" – 27"
Dispenser Height	14"	14" – 17"	17" – 19"



*Recommendations:* The Standards provide advisory (non-mandatory) guidance on the water closet height and centerline and the height of grab bars and toilet paper dispensers according to three age groups (above). The chosen specifications should correspond to the age of the primary user group. The specifications of one age group should be applied consistently in the installation of a water closet and related elements.

## Portable Toilet Units

Where portable single user toilet units are provided, including at temporary events, access is required to at least 5% in each cluster (213.2, Ex. 3). Compliant units must be labeled by the International Symbol of Accessibility (ISA). Portable units must meet all requirements for toilet rooms that apply, including fixture clearances, turning space, and door maneuvering clearances.

*An accessible route and entrance are required to serve portable units. Ramps necessary for changes in level must fully comply, and entrance landings must be sized to accommodate door maneuvering clearances and ramp landings.*

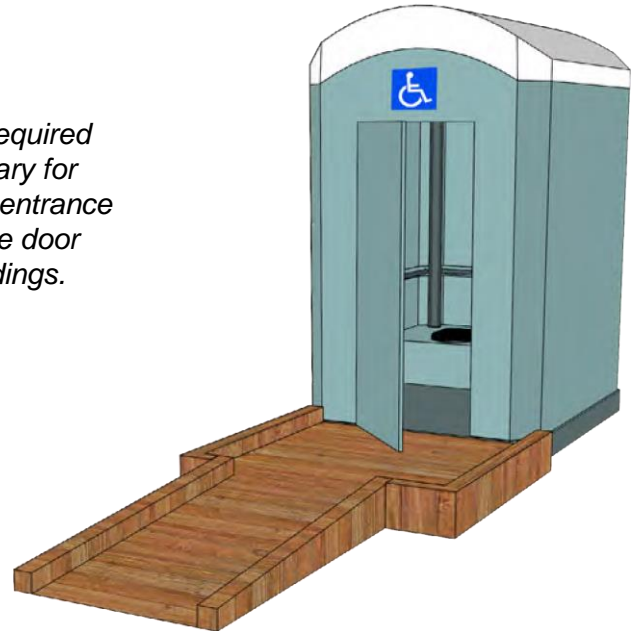
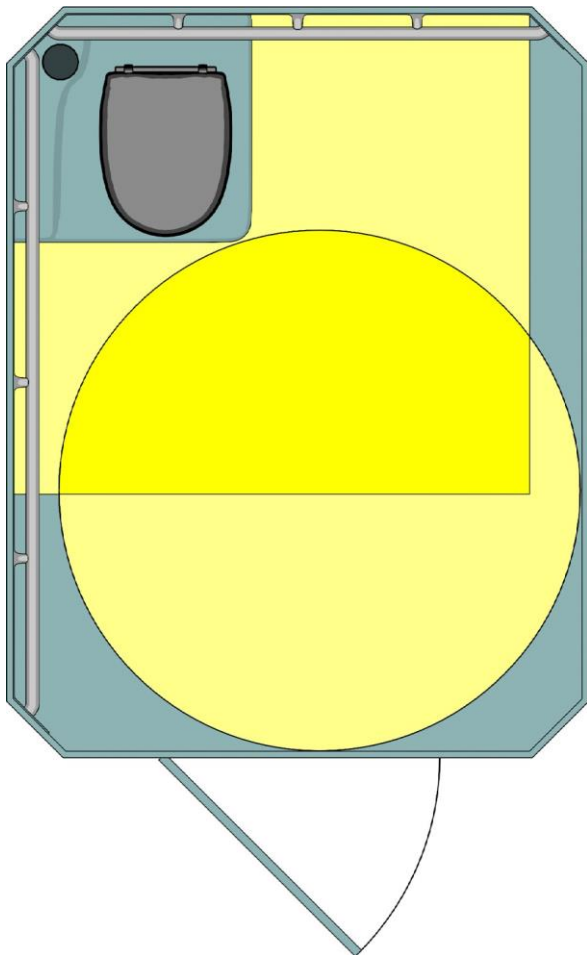

*Compliance with all other applicable provisions for water closets, including those for grab bars and clearance, is required. Other requirements for toilet rooms, such as door maneuvering clearance (not shown) and turning space also apply.*

## Multi-User Toilet Rooms

The Standards address toilet compartments and urinals which apply in addition to criteria for toilets, lavatories, mirrors, dispensers, shelves, and other elements provided.

### Components of Multi-User Toilet Rooms

*At least one wheelchair accessible toilet compartment (§213.3.1)*

*At least one compliant urinal where more than one urinal is provided (§213.3.3)*

*At least one compliant lavatory (not located in a toilet compartment) and at least one compliant mirror, where provided (§213.3.4 and §213.3.5)*

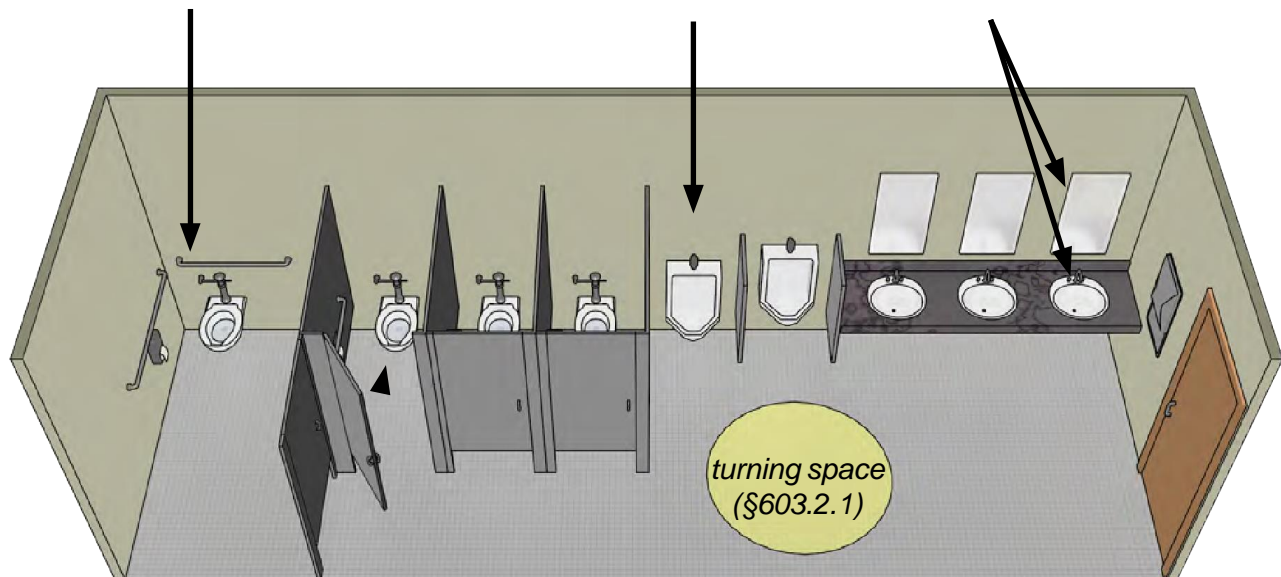

*At least one ambulatory accessible toilet compartment in restrooms with at least 6 toilet compartments or where the combined total of toilets and urinals is at least 6 fixtures (§213.3.1)*

*Dispensers, receptacles, and other operable parts must comply where provided (§205)*

*Doors, including toilet compartment doors, cannot swing into the clear floor space required at plumbing fixtures (§603.2.3), but they can swing into turning space.*



## Wheelchair Accessible Toilet Compartments [§213.3.1, §604.8]

At least one toilet compartment must be wheelchair accessible where toilet compartments are provided.

Compliant coat hooks and shelves where they are provided in other toilet compartments (§213.3.7, 604.8.3)

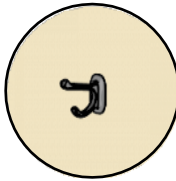

Compliant water closet with additional clear floor space required if fixture is floor mounted (59" instead of 56" deep) (§604.8.1.1)

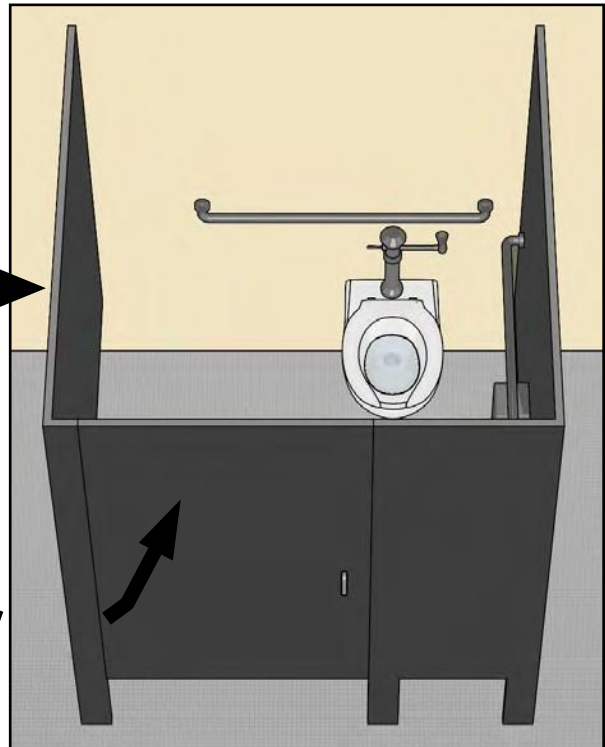
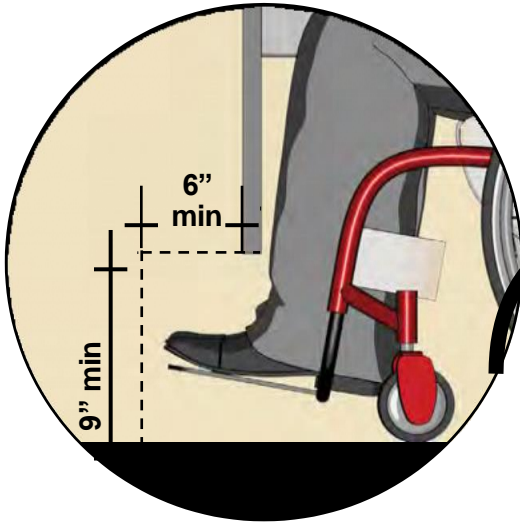

Toe clearance below the front and one side partition unless the compartment is enlarged to include toe space (§604.8.1.4) (partition vertical supports are permitted within this clearance)

A compliant door that is self-closing (§604.8.1.2)

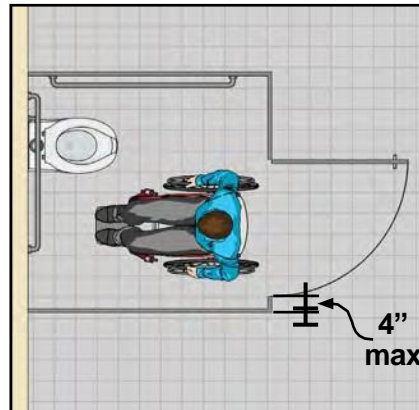

Compartment doors must be offset from the water closet in either the front or the side partition so that there is space to enter the compartment. Doors can be hinged on the left or right side of the opening.

## Compartment Doors [§404, §604.8.1.2]

Compartment doors must meet applicable requirements for doors, including the clear width (32" min.), hardware, and opening force (5 lbs. max.).

*Door must be self-closing (gravity or spring hinges are typically used). The min. closing time for spring hinges is 1.5 seconds measured from a 70° open position to the closed position.*

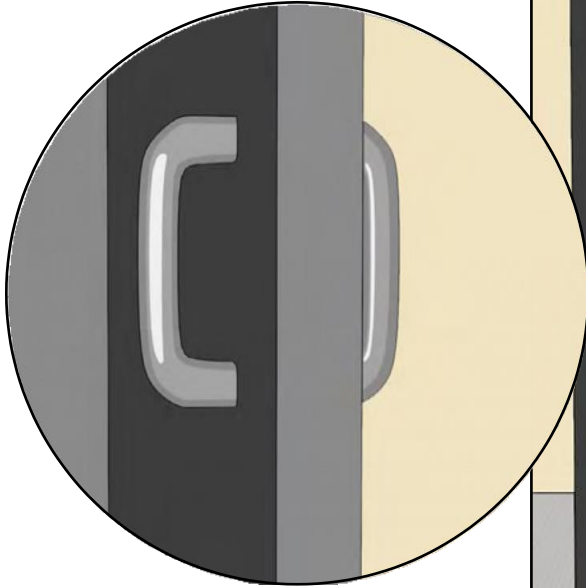

*Door pulls are required on both sides near the latch, 34" – 48" above the finish floor.*



*Doors cannot swing into the minimum compartment area specified.*

*Door pulls, latches and other hardware must comply as operable parts and be usable with one hand and not require tight grasping, pinching, twisting of the wrist, or more than 5 pounds force. Hardware that is usable with a loose grip or closed fist will accommodate a wider range of users. Latches with small parts that must be manipulated can be difficult to use and will not comply if pinching is necessary.*



**Recommendations:** Pulls should provide sufficient knuckle clearance (1½" minimum) to facilitate gripping. Avoid hardware, including latches, that requires hand or finger dexterity, fine motor movement, or simultaneous actions.

Compartment doors must meet maneuvering clearance requirements, but a reduced clearance is specified for compartment doors providing a latch approach. Doors can be hinged on either side.

 **Recommendation:** Hinging doors to provide a latch approach instead of a hinge approach will provide easier access and require less maneuvering clearance.

**Latch Approach Clearance**

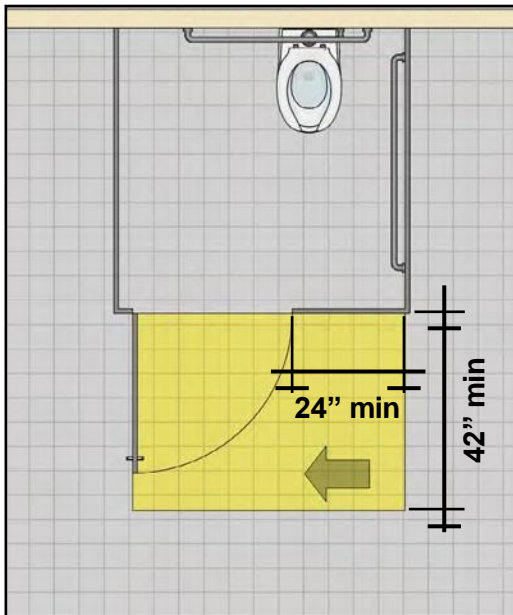

**Forward Approach Clearance**

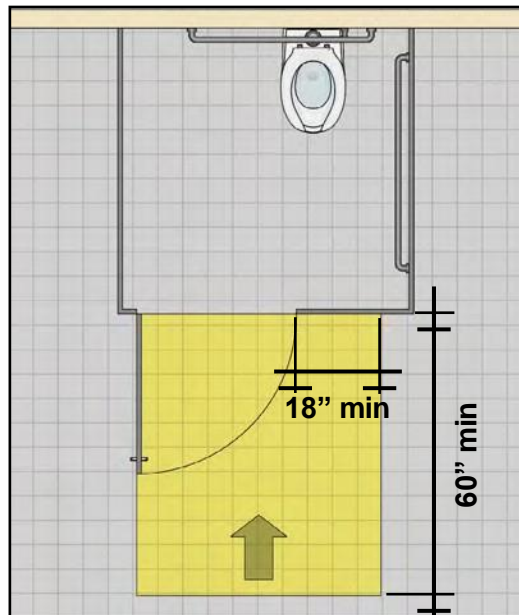

**Hinge Approach Clearance**

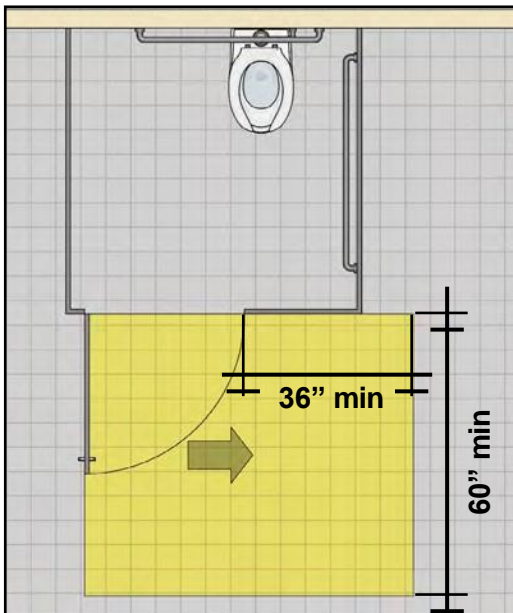

**Alternative Hinge Approach Clearance**

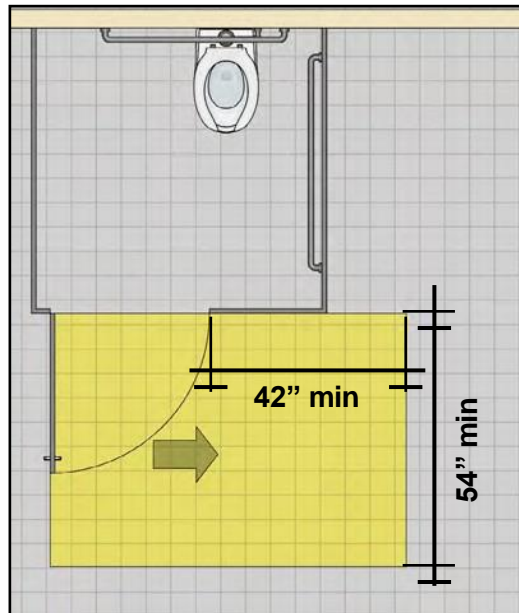

The required size of compartments provides the minimum space needed to enter, approach and transfer to water closets, and exit. As with water closets generally, the only elements that can overlap the minimum compartment/water closet clearance are: the water closet, associated grab bars, dispensers, coat hooks, shelves, and sanitary napkin disposal units. Other elements and fixtures, including baby changing tables in the stowed position, cannot overlap this clearance. If an additional plumbing fixture, such as a lavatory, is provided in a compartment, the compartment must meet the requirements for single-user toilet rooms in §603.

Toilet compartments are typically enclosed by partitions. Full-height partitions and door assemblies are not prohibited but will require a larger compartment because toe clearance below partitions is not available.



*Recommendations:* The dimensions specified represent the minimum necessary for access. Providing additional space within compartments will enhance usability.

### Compartment with Toe Clearance Below Partitions

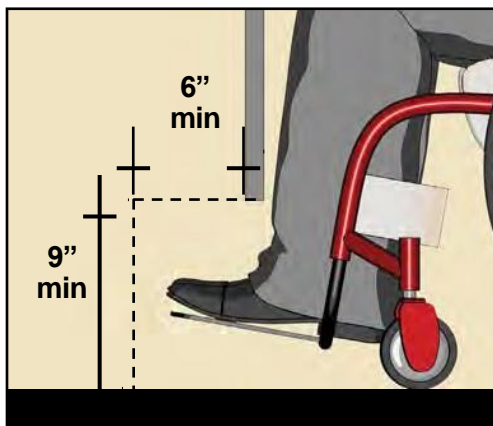

**56" min**  
wall-mounted water closet  
**59" min**  
floor-mounted water closet

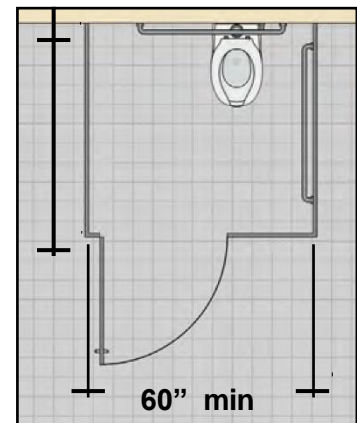

### Compartment without Toe Clearance Below Partitions

**No toe clearance at front partition:**  
greater than **62"**  
wall-mounted water closet  
greater than **65"**  
floor-mounted water closet

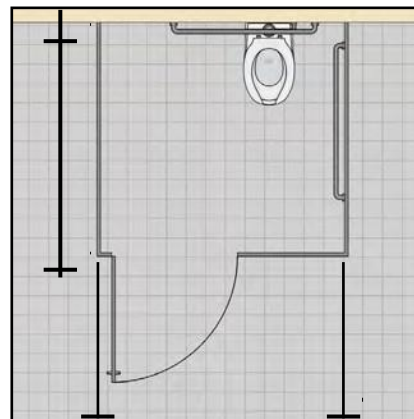

**No toe clearance at side partition: greater than 66"**



## Toilet Compartments Designed for Children's Use [§604.8.1]

Toilet compartments designed for use by children 12 and younger must be slightly larger (59" wide for wall- or floor-mounted water closets) because children's maneuvering skills are generally less refined. The toe clearance must be at least 12" high to accommodate footrests that are higher above the floor. As with adult-sized compartments, additional space is required if toe clearance is not available below partitions.

**59" min**  
(greater than 65" if no toe clearance at front partition)

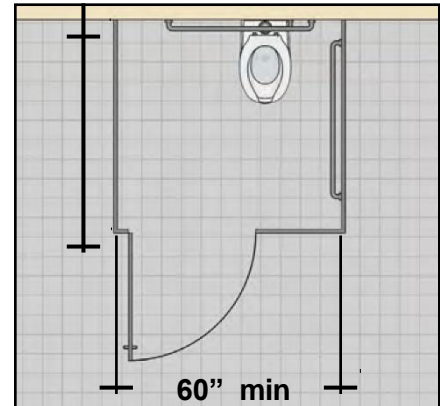

(greater than 66" if no toe clearance at a side partition)

## End-of-Row Toilet Compartment

Wheelchair accessible toilet compartments located at the end of the row can provide more room by incorporating dead-end aisle space. The door can swing in if it clears the minimum compartment area. The compartment door can be located in the side partition that is closer to the water closet when the door opening is beyond the minimum depth of the compartment area.

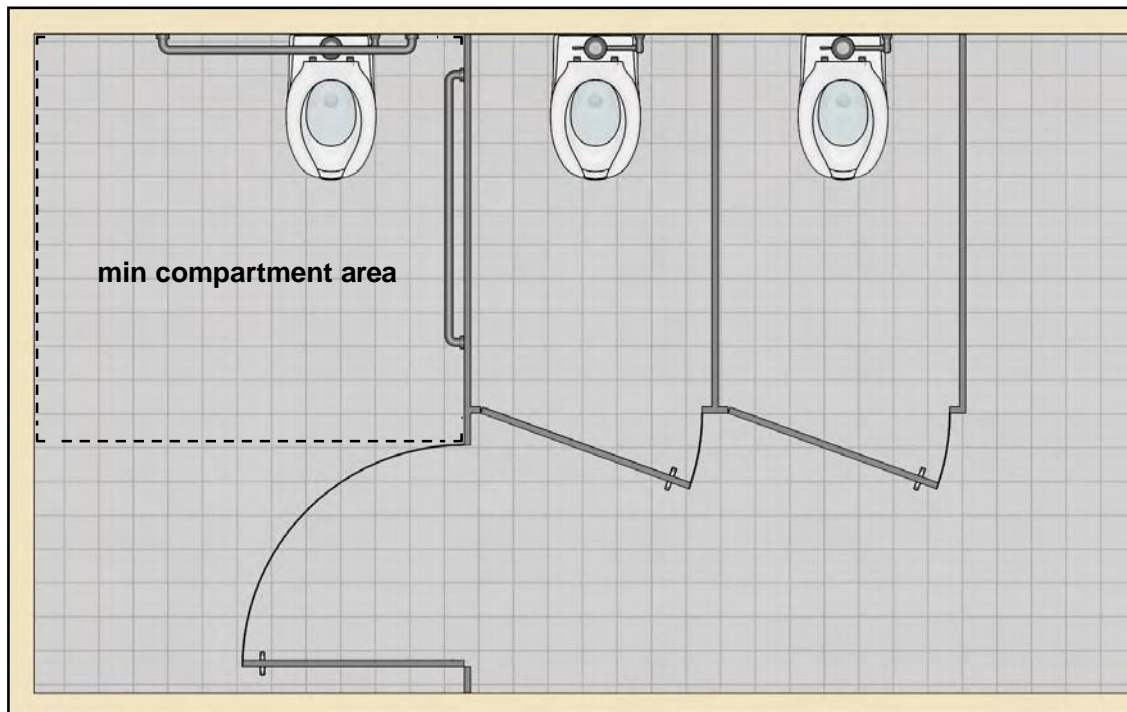

### Toilet Compartment with a Lavatory [§603, §604.8]

No other fixture besides the toilet can be located in the minimum space required for the compartment. If a lavatory or another plumbing fixture is located in a compartment, the compartment must meet requirements for toilet rooms, including turning space. Another compliant lavatory is required outside the compartment. Another compliant lavatory is required outside the compartment.

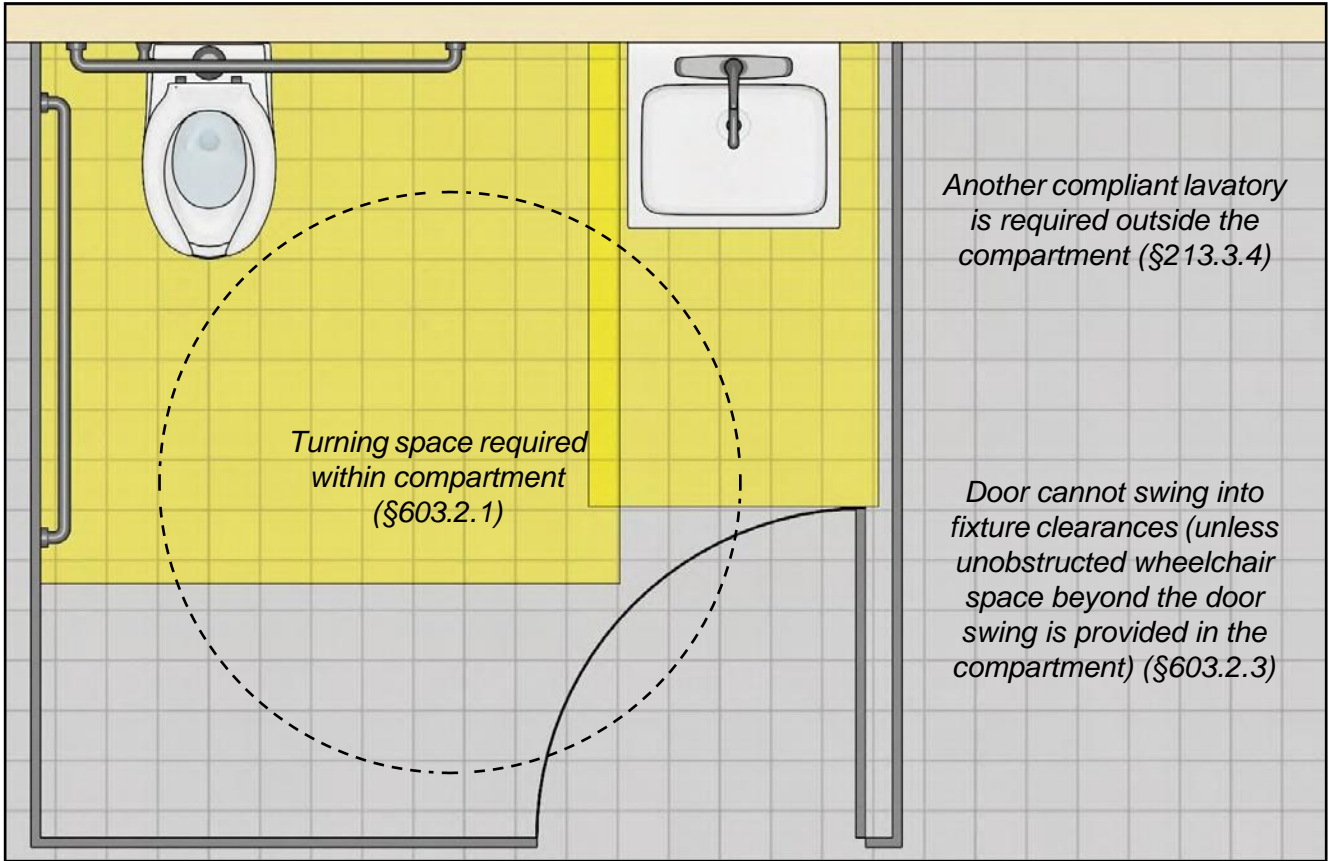

### Ambulatory Accessible Toilet Compartment [§213.3.1, §604.8]

Ambulatory accessible toilet compartments provide parallel grab bars and benefit people who use crutches, canes, walkers and similar devices or who need support in sitting or standing. They do not accommodate wheelchairs or scooters and are required in addition to the wheelchair accessible compartment in toilet rooms with six or more toilet compartments or where the combined total of toilets and urinals is six or more. They are sized so that both grab bars are within reach. Grab bars must meet specifications for size, location, and securement.

*The compartment width is specified so that both grab bars are simultaneously within reach.*

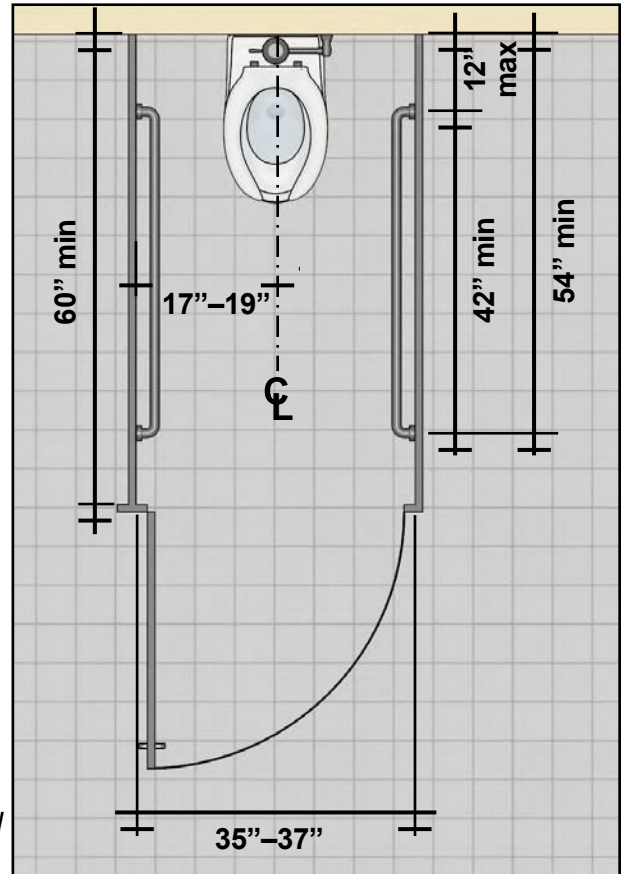

*Like wheelchair accessible compartments, doors must fully comply and be self-closing, have a pull on both sides near the latch, and cannot swing into the required compartment area. All other applicable door criteria, including maneuvering clearances, must be met.*

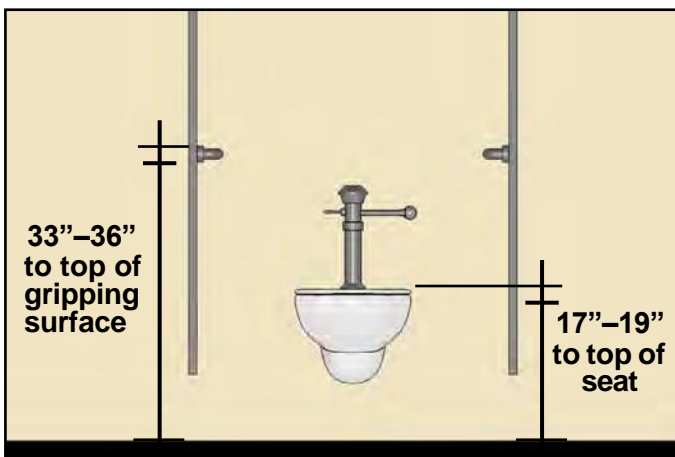

*Water closets must comply, including flush controls which must meet criteria for operable parts if hand-operated. Seats cannot be sprung to return to lifted position. Requirements for toilet paper dispensers, coat hooks, and shelves also apply.*

## Urinals [§213.3.3, §605]

At least one urinal must comply where two or more urinals are provided in a toilet room. Specifications address rim height, depth, flush controls, and clear floor space. Accessible urinals must be either wall hung or stall type. Flush controls must be automatic or, if hand operated, compliant as operable parts and located within accessible reach range (§309).

Wall Hung Urinal

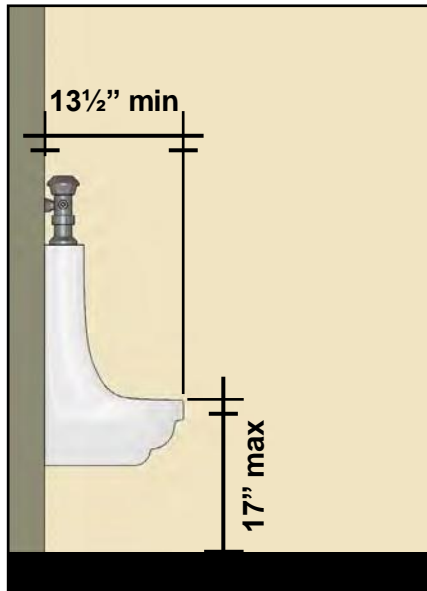

Stall Type Urinal

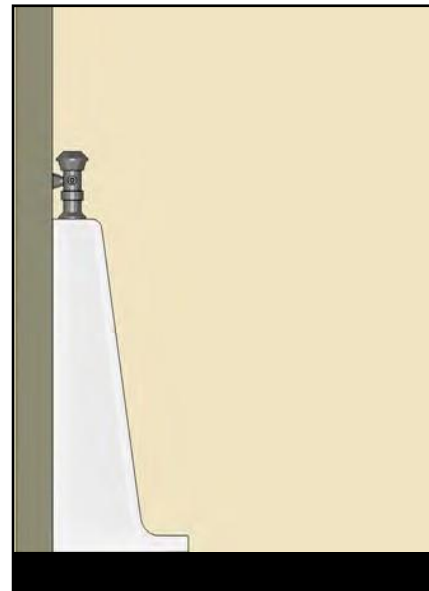

Clear floor space for a forward approach is required. Partitions or privacy panels cannot obstruct or reduce the minimum clearance. If partitions or panels obstruct both sides of the clear floor space for more than 24", the clear floor space must be at least 36" wide instead of 30" wide.

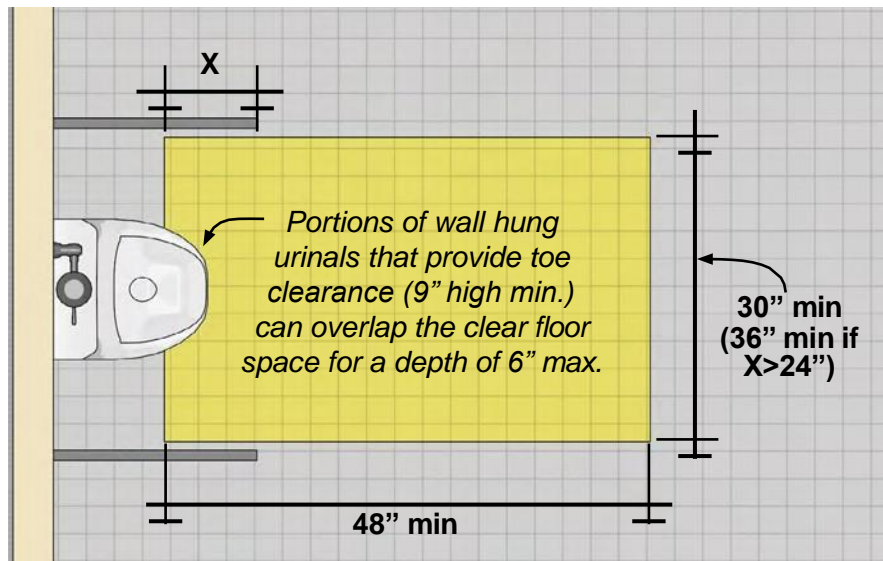

## Toilet Room Signs [§216 and §703]

Where provided, signs that identify permanent rooms and spaces, including toilet rooms, must have raised characters and braille and meet criteria for visual access (§216.2). Visual content and tactile content can be provided on separate signs.

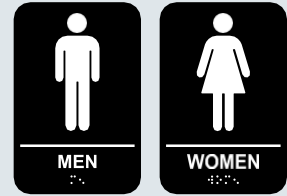

If pictograms are provided to identify toilet rooms (i.e., symbols for men's, women's, and unisex restrooms), they must be on a field at least 6" high, include the verbal equivalent below in raised characters and braille, and meet finish and contrast specifications (§703.6). These pictogram requirements do not apply to any informational pictograms that are also provided on the sign, including the International Symbol of Accessibility (ISA). If not all toilet rooms are accessible, those that comply must be labeled by the ISA. The ISA can be included on the toilet room sign or be provided separately.

Where existing toilet rooms in an alteration do not comply, signs with the ISA must be provided indicating the location of the nearest accessible toilet room, and those that comply must be labeled by the ISA as well (§216.8). The content of directional signs is not specified.



## Common Questions



### Toilet Rooms

*Are toilet rooms that serve employees but not the public required to comply?*

Yes. Public and common use toilet rooms, including those used exclusively by employees, must comply. Private toilet rooms for a single occupant accessed only through a private office are permitted limited exceptions for certain access features, such as the later installation of grab bars if walls have blocking or are reinforced.

*Can access be provided to a unisex restroom instead of to men's and women's rooms?*

If men's and women's rooms are provided, they must be accessible even if a unisex toilet room is also provided. However, in alterations when it is technically infeasible to make existing men's and women's rooms comply, an accessible unisex toilet room can be provided instead if it is located on the same floor and in the same area as the men's and women's rooms (§213.2, Ex. 1).

*Is access required to a unisex family or gender-neutral toilet room that is provided in addition to accessible men's and women's rooms?*

Yes. Unisex toilet rooms must be accessible, including where they are provided in addition to multi-user toilet rooms. Where multiple single-user toilet rooms are clustered at one location, no more than half for each use are required to comply (§213.2, Ex. 4).

*How does the exception for clustered single user toilet rooms of the same type (no more than 50% at each cluster) apply when there is an odd number of toilet rooms?*

When there is an odd number of single user toilet rooms of the same type in a cluster, the number of accessible toilet rooms can be rounded up or down. Rounding up is recommended for better access and is otherwise required when fractions or remainders result in determining the number of facilities or elements required to comply (§104.2). However, rounding down is permitted in this instance because the exception for clustered single user toilet rooms states that "no more than 50 percent of the single user toilet rooms for each use at each cluster shall be required to comply" (§213.2, Ex. 4).

*Is there a maximum distance or separation that applies to toilet rooms within the same cluster?*

No maximum distance is specified, but clustered single user toilet rooms are those that are next to, or close to, one another.

*What is the impact of providing two unisex toilet rooms instead of a designated single-user men's room and a designated single-user women's room?*

If two unisex restrooms of the same type are clustered in one location, only one of the two is required to comply under the Standards (§213.2). If a single-user men's room and a single-user women's room are provided, both must comply even if clustered since they are different types.

*Can toilet rooms be designed for assisted instead of independent access?*

The Standards address independent accessibility and do not contain requirements for spaces and elements designed for assisted use. In medical care facilities, features for assisted use that conflict with the Standards can be provided in those toilet or bathing rooms serving patient bedrooms that are not required to comply with the Standards. Otherwise, any departure from the Standards, including those related to assisted use, must be based on the provision for "equivalent facilitation" (§103) which permits alternatives to specified requirements that provide substantially equivalent or greater accessibility and usability.

*In facilities that are exempt from the requirement for vertical access between stories, are toilet rooms required to comply on stories not connected by an accessible route?*

Yes. In facilities that are not required to provide an accessible route between stories based on the story count or square footage per floor (§206.2.3, Ex. 1 or 2), all other provisions in the Standards, including those for toilet rooms, still apply to levels and stories not connected by an accessible route. In addition, if a toilet room is provided on an inaccessible story of such a facility, a toilet room also must be provided on an accessible story so that it is connected to an accessible entrance by an accessible route (§213.1).

*What is the minimum size of toilet rooms?*

The standards do not specify the minimum size of toilet rooms. The required size of a toilet room is determined by room layout, the number and configuration of fixtures provided, required clearances, the presence of baby changing tables and other amenities, turning space, door maneuvering clearances, and other factors and requirements.

*Can doors swing into the turning space and fixture clearances?*

Doors can swing into the turning space. They cannot swing into the clearance required at plumbing fixtures, except in single user toilet rooms where clear floor space 30" minimum by 48" minimum is provided in the room beyond the arc of the door swing (§603.2.3, Ex. 2). In addition, doors can swing into fixture clearances at single-occupant toilet rooms accessed only through a private office and not for common use if the swing of the door can be reversed (§603.2.3, Ex. 1).

*When is a toilet room required to be designed for children?*

The Standards do not require that toilet rooms be designed for children. This determination is usually made based on other building requirements or regulations, good practice, or client preference. However, the Standards do provide alternate specifications based on children's dimensions that can be followed where a toilet room is designed for children.

*If a restroom serves both adults and children, must an accessible toilet compartment be provided for both adults and children?*

In restrooms that serve both adults and children, it is advisable, but not required, to provide wheelchair accessible toilet compartments for both user groups, but the Standards require only one wheelchair accessible toilet compartment in all toilet rooms.

*Can elements with knee and toe space overlap the required turning space?*

Yes. Elements that provide compliant knee and toe space, such as lavatories, can overlap a portion of the turning space.

*Can elements with knee and toe space overlap the door maneuvering clearance?*

No. Elements, including those providing knee and toe space, cannot overlap or protrude into the maneuvering clearance required at doors and doorways. However, door maneuvering clearances can be offset up to 8" from the face of the door to accommodate wall thickness, casework, shelves, or other elements adjacent to doorways, including grab bars. The door maneuvering clearance must be measured from the leading edge of such elements so that the full clearance is free of any obstruction.

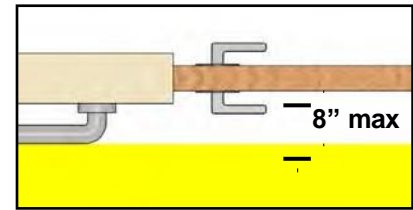

*Grab bars and other elements cannot overlap the door maneuvering clearance but can be located within the 8" max. offset from the face of the door.*

*Must toilet rooms be identified by the International Symbol of Accessibility (ISA)?*

Labeling accessible toilet rooms with the ISA is required only where inaccessible toilet rooms are present. For example, half of single user toilet rooms of the same type in each cluster (5% in the case of portable units) are required to comply, and those that are accessible must be identified by the ISA unless all are accessible (§213.2, Ex. 4, §216.8). In alterations where existing toilet rooms do not comply, directional signs with the ISA must be provided to indicate the location of the nearest accessible toilet room which must be labeled by the ISA.

*Do the Standards require restroom pictograms?*

No. The ISA is the only pictogram the Standards require in labeling toilet rooms. Other codes or regulations may require pictograms to identify men's and women's rooms and unisex restrooms. The Standards require that pictograms labeling permanent rooms and spaces, including toilet rooms, be on a field at least 6" high and include the verbal equivalent in raised characters and braille below the pictogram. Informational pictograms, such as the ISA, are not subject to the requirements for field height or verbal text.

*Do the Standards require accessible toilet compartments, including the ambulatory accessible compartment, to be labeled by the ISA?*

No. The Standards do not require toilet compartments to be identified by the ISA.

## **Water Closets**

*Can an adjacent lavatory overlap the water closet clearance?*

No. Lavatories are not permitted to overlap the 60" wide minimum space at water closets, except in residential dwelling units if the water closet clearance is 66" deep min. (§604.3.2, Ex.). Lavatories (or other plumbing fixtures) can be adjacent to the water closet if recessed so as not to overlap the water closet clearance. (The rear grab bar can be 24" long in this instance if there is not sufficient wall space for a 36" grab bar.)



*Can other elements overlap the water closet clearance?*

The only elements beside the water closet that can overlap the water closet clearance are: associated grab bars, dispensers, coat hooks, shelves, and sanitary napkin disposal units (§604.3.2). No other elements can overlap the water closet clearance.

*Can the toilet paper dispenser be mounted above the side grab bar?*

Toilet paper dispensers can be mounted above the side grab bar if they do not protrude into the 12" high minimum clearance above the bar and the outlet is within the maximum 48" height. With large roll dispensers, ensuring that the outlet is within the height limit can be difficult when mounted above bars unless they are recessed.

*How is the distance from the water closet measured for toilet paper dispensers with large or multiple rolls?*

The required distance of toilet paper dispensers from the front of the water closet (7" – 9") is measured to the centerline of the dispenser, including large-roll and multiple-roll dispensers.

*How can conflicts between the rear grab bar and the required location of flush controls be resolved?*

If plumbing codes require a flush control location that conflicts with the rear grab bar, the grab bar may be split or shifted to the open side. This is permitted only where applicable codes mandate flush controls in such a location.

*Are automatic (motion sensor) flush controls required to be on the open side of the water closet?*

No. Motion activated flush controls are not required to be on the open side of the water closet. If a water closet has a manual flush control in addition to a motion activated one, it is recommended, but not required, that the manual control be located on the open side of the water closet. Manual flush controls, even those intended for custodian use, are helpful at water closets and urinals when the motion sensor fails to activate.

*Are flush controls located on valves, walls, or tanks that are centered on the fixture compliant (i.e., on the open side)?*

Manual flush controls, including push buttons, must be usable from a point between the centerline and the open side of the fixture. A portion of the control can be outside the range if it is usable without having to reach beyond the water closet centerline from the open side.

*Can the side and rear grab bars be continuous?*

Yes. The rear and side grab bar can be continuous or separate, but in either case must comply with the specified length and placement.

*Must the side and rear grab bar both be at the same height within the specified 33" – 36" range?*

The Standards do not require both grab bars at the water closet to be at the same height, although this is advisable. (Horizontal grab bars at showers must be at the same height.)

*Can the side grab bar be located on a half wall or wing wall?*

Grab bars, if properly secured, can be mounted on a half wall or wing wall where sufficient wall surface above the grab bar is available. Wall surface above grab bars provides support and helps prevent arms from slipping off the bar. Wall surface that extends the full height of the required 12" clearance above grab bars, or preferably to the standard adult shoulder height for standees, should provide sufficient support in using grab bars.

*Can the side grab bar be mounted on blocking when the centerline of the water closet exceeds the 18" maximum?*

In new construction, the wall should be furred out so that the water closet centerline is within the required 16" – 18" distance from the side wall. In addressing access to existing water closets that are too far from the side wall, the side grab bar can be mounted on blocking but it is important that the blocking extend at least 12" above the grab bar so that adequate wall support is available when using the grab bar.

*Can grab bar attachments be located at points along the bar instead of at the ends?*

Yes. Grab bar attachments can be at points other than the ends of grab bars.

*How is the length of grab bars measured?*

Grab bar length is measured to the centerline of the return, consistent with industry convention. This also applies to post-mounted grab bars. When attached at points other than the ends (e.g., "European" style grab bars), the length is measured to the end of the bar.

*Can grab bars be mounted to the floor instead of the wall?*

No. The Standards require grab bars at water closets on the side and rear wall (§604.5). Grab bars that are floor-mounted obstruct usable clear floor space at the water closet and may be difficult to secure.

*Must grab bars have a peened or other textured surface?*

No. The Standards do not require grab bars to have peened or textured surfaces.

*Are folding or swing-away grab bars permitted on the open side of water closets?*

Folding or swing-away grab bars are not prohibited by the Standards so long as they do not obstruct use of the required grab bars. It is important that they are properly secured.

*Is a vertical grab bar required by the Standards?*

No. The ADA Standards do not require a vertical grab bar at water closets. However, the ICC A117.1 standard, which is referenced by the International Building Code, requires an 18" minimum vertical grab bar on the side wall above the horizontal grab bar for people who are ambulatory. This grab bar can be located within the 12" minimum clearance required above the horizontal grab bar.

*Can grab bars have infill plates to prevent suicide or security risks in detention and correctional facilities?*

In detention and correctional facilities, grab bars must fully comply at water closets serving accessible cells. Infill plates and other anti-ligature measures may be provided in detention and correctional facilities and other facilities so long as they do not impede gripping surfaces. Grab bars are not required in those cells that are specially designed without protrusions for suicide prevention (§604.5, Ex. 3).

## **Toilet Compartments**

*What distinguishes "toilet compartments" from single-user "toilet rooms"?*

In some cases, it may be unclear whether water closets enclosed by full height partitions are to be treated as toilet compartments or single-user toilet rooms under the Standards. Toilet compartments can have full-height partitions. The determination typically is based on whether the toilet compartment is located within a restroom/ bathing facility or if it is entered directly from a common use corridor or exterior route. Those located within a room (such as a men's room, women's room, or gender neutral multi-user restroom, locker room, shower room) can be scoped as toilet compartments under the Standards: at least one wheelchair accessible and, if six or more water closets/urinals are provided, at least one ambulatory accessible compartment (§213.3.1). Those that directly connect to, or are separated by, a hallway, corridor, or exterior route, are scoped as single-user toilet rooms: all must comply except that where clustered, 50% of each use must comply (§213.2). If a toilet compartment contains more than one plumbing fixture (e.g., a lavatory), it must comply as a toilet room (§604.8).

*Can compartment door openings be located more than 4" from the side partition when the compartment width exceeds the 60" minimum?*

The Standards require the door opening to be located 4" maximum from the side partition further from the water closet (or, if located in the side partition, 4" maximum from the front partition). An increase above the 4" maximum where compartments exceed the 60" minimum width may not impact usability if the extra width of the compartment equals or exceeds the increase above the 4" maximum (as permitted by the ICC A117.1 Standard), but such a departure must be based on the provision of equivalent facilitation (§103).

*Are toilet compartment doors prohibited from swinging into fixture clearances?*

Yes. Toilet compartment doors, including those of inaccessible compartments, cannot swing into clearances required at lavatories and other plumbing fixtures. In addition, the compartment doors cannot swing into the minimum required area of wheelchair accessible and ambulatory accessible compartments.

*Are spring hinges and gravity hinges on compartment doors considered “closers” in determining the size of maneuvering clearances?*

No. Some approaches require additional maneuvering clearance when a door or gate is equipped with a closer because of the additional force that must be counteracted in proceeding through doors. Since spring and gravity hinges do not significantly impact maneuvering at doors, they are not “closers” for purposes of specifying door maneuvering clearance.

*Can accessible toilet compartments have full-height walls instead of partition panels?*

Yes. But the minimum compartment size (both width and depth) is increased more than 6” if minimum toe clearance is not provided below the front partition and a side partition. Doors, including full door assemblies, must be self-closing and meet all applicable requirements for doors.

*Can pilasters or other partition supports intrude into the required toe clearance below partitions?*

Yes. Vertical supports for partitions are permitted within the required toe clearance. The width of supports is not specified or limited by the Standards.

## **Lavatories and Mirrors**

*Can a lavatory be located outside of a toilet room?*

The Standards do not prohibit location of lavatories outside toilet rooms where permitted by codes and other regulations.

*Can a lavatory be provided in a wheelchair accessible toilet compartment?*

Yes. But the toilet compartment must meet requirements for toilet rooms, including turning space (§604.8). A second accessible lavatory must be provided outside the compartment (§213.3.4).

*Must the clear floor space at lavatories be centered?*

It is advisable, though not required, that the clear floor space be nominally centered on the fixture.

*Can accessible mirrors be located above lavatories?*

Accessible mirrors can be located above lavatories or countertops if the bottom of the reflecting surface is 40" max. above the finish floor (§603.3). The bottom of the reflecting surface of mirrors not located above lavatories or countertops must be 35" max. above the finish floor.

*If a toilet room has a full-length mirror and a mirror above a countertop or lavatory, must both types comply?*

No. The Standards require only one mirror in a toilet room to comply. If mirrors are provided above lavatories or counters and at other locations in a toilet room, it is advisable, but not required, that one of each type comply.



**UNITED STATES ACCESS BOARD**

Advancing Full Access and Inclusion for All

1331 F Street, NW ▪ Suite 1000 ▪ Washington, DC 20004-1111  
(202) 272-0080 (v) ▪ (202) 272-0082 (TTY) ▪ [www.access-board.gov](http://www.access-board.gov)

April 2020



## U.S. Access Board Technical Guide

### Washing Machines and Clothes Dryers

This guide explains requirements in the ADA Standards for washing machines and clothes dryers.

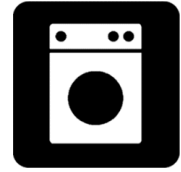

#### Required Compliance [§214]

Scoping for washing machines and clothes dryers is applied independently. Where up to three washing machines are provided, at least one must comply. If more than three washing machines are provided, at least two must comply. The same level of accessibility is required for clothes dryers.

These requirements apply to various types of laundry facilities, including, but not limited to, those serving residential dwelling units, dormitories and other types of transient lodging, laundromats, and recreation facilities.

Washing machines and clothes dryers only used by employees to perform work are not required to comply, although compliance is advisable (§203.9).



**Recommendation:** It is advisable to make most or all washing machines and clothes dryers accessible since those that are accessible may at times be unavailable.

## Washing Machines and Clothes Dryers [§611]

The Standards address both top-loading and front-loading washing machines and clothes dryers. Requirements address clear floor space, operable parts, and height.

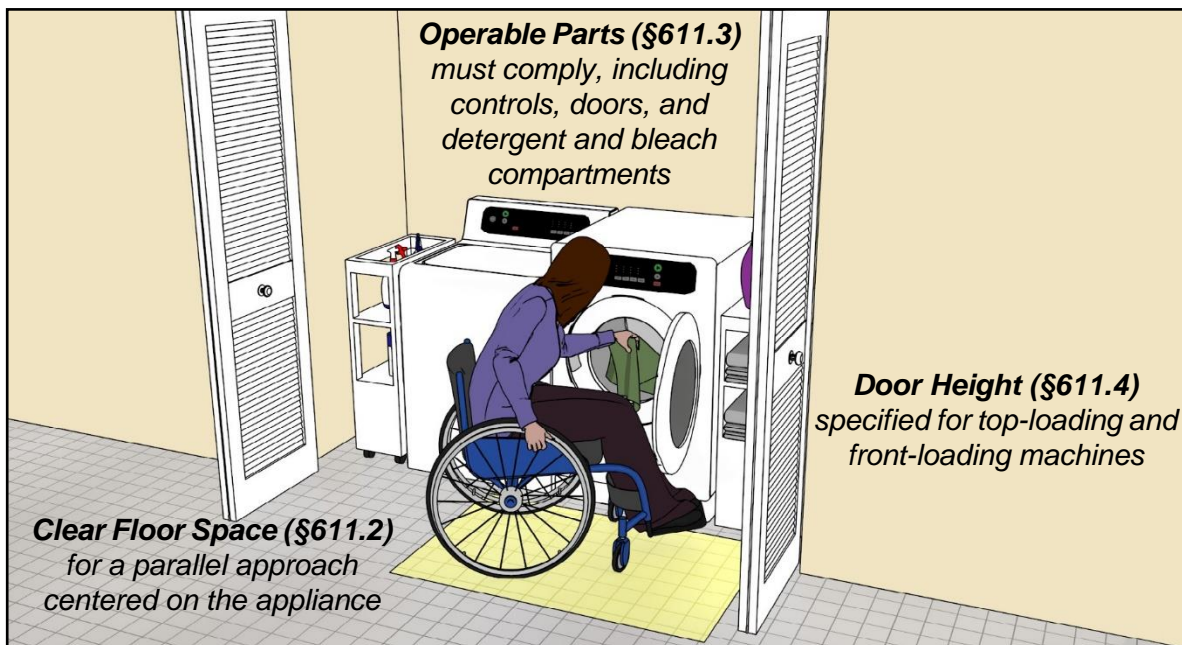

### Clear Floor Space [§611.2]

Clear floor space must be centered on the appliance and positioned for a parallel approach. Enclosures, including doors when open, cannot overlap or obstruct the clear floor space. Where clear floor space is recessed in alcoves and confined on three sides, additional maneuvering clearance is required. (See the Clear Floor or Ground Space and Turning Space Guide)

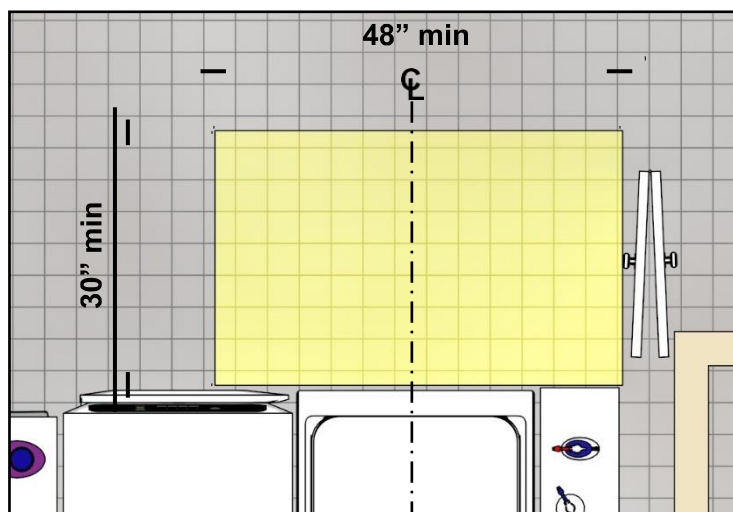

Clear floor space must comply with §305 and be centered on each appliance.

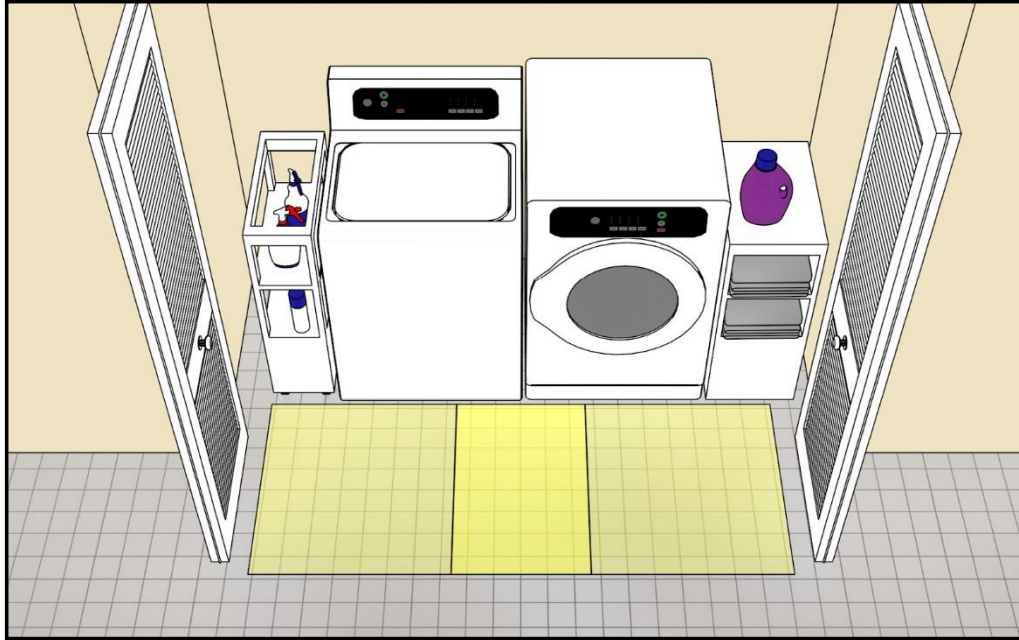

*Centered clear floor spaces for each machine may partially overlap.*

### Height [§611.4]

Height of top-loading machines must be 36" maximum above the finish floor. For front-loading machines, the height of the bottom of the opening of the door must be between 15" and 36" above the finish floor.

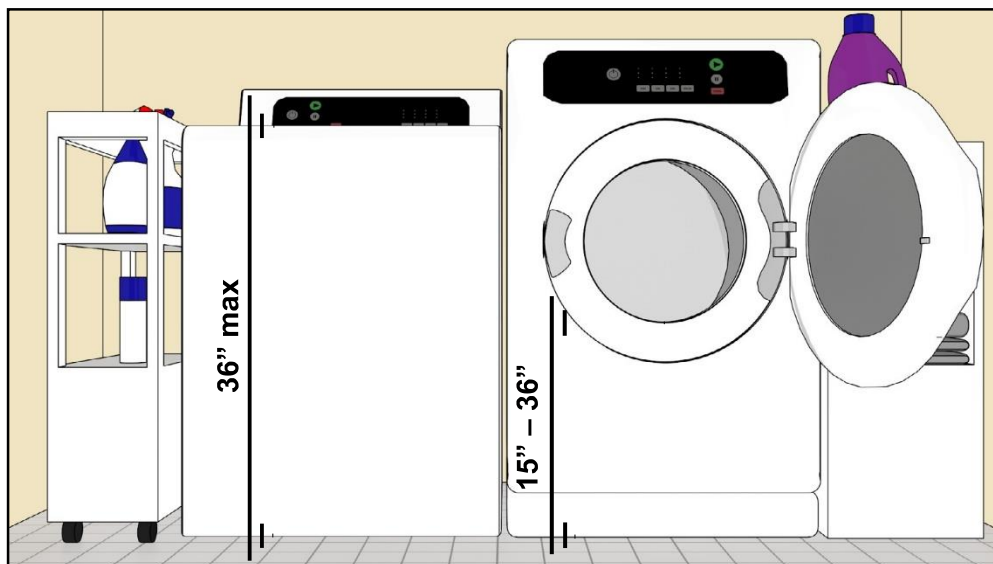

*Recommendation:* Top-loading machines with doors hinged on the side provide easier access than those with doors hinged at the back. Doors on front-loading machines should be hinged at the side instead of the bottom and swing as close to 180 degrees as feasible to allow greater access to the drum.



### Operable Parts [§611.3, §309]

Operable parts of machines, including controls, doors, detergent and bleach compartments, and lint screens must comply. They also must be within accessible reach range and usable with one hand and without tight grasping, pinching, twisting of the wrist, or more than 5 pounds of force.

Coin slides or payment units need to comply with operable parts requirements. Change machines and vending machines also must comply (§228.1).



*Recommendation:* To accommodate people who have visual impairments, operable parts should be discernable by touch or sound without activation.

### Obstructed Side Reach and Unit Height [§308]

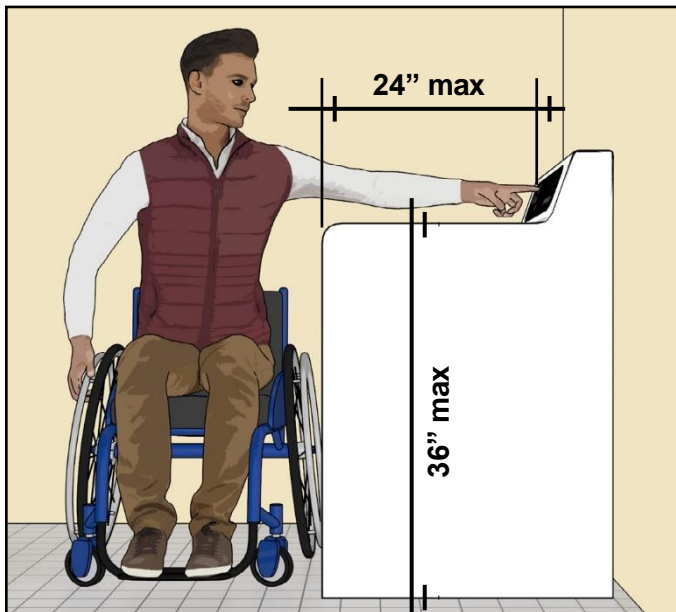

Although top-loading washing machines create an obstruction for users with side reach to operable parts, washing machines and clothes dryers are permitted to be 36" maximum in height above the finish floor (§308.3.2, Ex. 1). The side reach for parallel approach is 24" maximum depth.



*Recommendation:* Washers and dryers with controls, including coin slides or payment units, located at the front of the machine provide easier access and accommodate a broader range of users.

## Common Questions



*Can a combination single-unit washer and dryer be used if compliant?*

An all-in-one unit with a single drum that functions as both a washer and a dryer can be used if it complies with all applicable requirements. If separate washers and dryers are otherwise provided, then it is important that accessible washers and dryers also be separate appliances for equivalent usability and convenience. Where appliances are stacked, including combination washers dryers, accessible units typically need to be separate (i.e., side-by-side) to meet reach range and door opening requirements.

*Are washers and dryers used by employees required to comply?*

Washers and dryers used only by employees for work purposes, such as those in laundry rooms used by staff in hotels and hospitals, are not required to meet accessibility requirements. However, washers and dryers provided for non-work use by employees, such as those in laundry facilities in an employee dormitory, are required to comply.

*Can closet or laundry room doors overlap clear floor space at washers and dryers?*

No. Closet or laundry room doors must fully clear the required wheelchair space when open.

*Do compliant washers and dryers need to be labeled as accessible in laundry facilities with multiple washers and dryers?*

No. However, in laundry facilities where not all appliances are accessible, it is advisable to identify those that are with the International Symbol of Accessibility.

*Do portable or temporary washers and dryers need to comply?*

Yes. Where three or fewer portable or temporary washers are provided, at least one must comply. Where more than three washers are provided, at least two units must comply. The same scoping applies to dryers.



### UNITED STATES ACCESS BOARD

Advancing Full Access and Inclusion for All

1331 F Street, NW ▪ Suite 1000 ▪ Washington, DC 20004-1111  
(202) 272-0080 (v) ▪ (202) 272-0082 (TTY) ▪ [www.access-board.gov](http://www.access-board.gov)

September 2021