

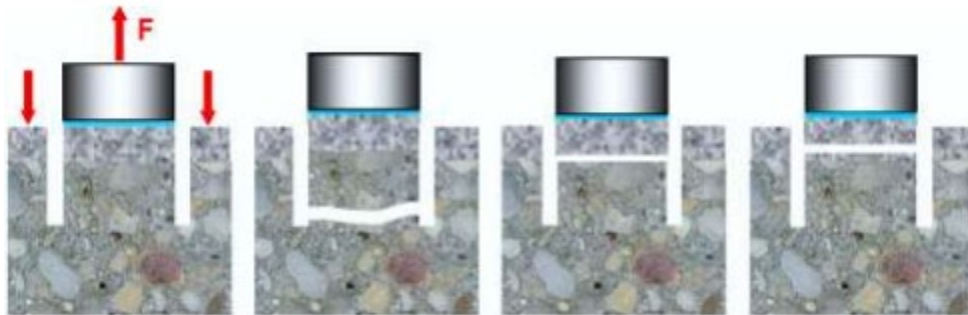

Concrete Testing



8

Professional Development Hours (PDH) or

Continuing Education Hours (CE)

Online PDH or CE course

Contact information

www.PDHexpress.com

pdhexpress@gmail.com

Telephone: 713-787-6810

Corporate Mailing address:

2500 Tanglewilde, Suite 220

Houston, Texas 77063

For all your questions and instructor support please contact us via email or phone.

All emails and phone calls are addressed within 24 hours.

Operating hours: 9 AM – 4 PM Central Time

Tel: 713-787-6810

Fax: 713-787-6825

Email: pdhexpress@gmail.com

Table of Contents

Abstract:	
1. Introduction	1
1.1 Background	1
1.2 Objectives.....	2
1.3 Scope.....	2
2. Repairing of concrete structures	3
2.1 Introduction	3
2.2 Crack repairs	3
2.3 Concrete fundamental repairs.....	4
2.4 Causes of damages	5
2.5 Shotcrete as a repair material	7
2.5.1. Background.....	7
2.5.2 Dry mix and Wet mix	7
2.5.3 Shotcrete application.....	8
2.5.4 Shotcrete benefits in repair projects	9
2.6 Importance of bonding in concrete repairs.....	10
3. Bond in concrete.....	11
3.1. Definition of the bond strength	11
3.2. Main factors influencing bond	12
3.2.1 Cleanliness	12
3.2.2 Surface preparation	12
3.2.3 Laitance	17
3.2.4 Compaction and placement of the overlay.....	18
3.2.5 Overlay curing and temperature effect.....	21
3.3 Secondary factors influencing bond.....	24
3.3.1 Overlay properties.....	24
3.3.2 Pre wetting	25
3.3.3 Time.....	25

3.4 Other factors influencing bond.....	26
3.4.1 Traffic vibrations	26
3.4.2 Bonding agent.....	27
3.4.3 Environmental factors.....	27
3.4.4 Mechanical device crossing the interface	27
4. Test methods to evaluate bond strength.....	29
4.1 General classification	29
4.2 Tensile tests.....	33
4.2.1 Pull-Off test	33
4.2.2 Test Procedure	34
4.3 Compressive-shear test.....	36
4.3.1 Slant shear test	36
4.3.2 Test description.....	37
4.3.3 Problems reported for “Slant Shear Test Method”.....	38
4.4 Shear tests	41
4.5 Torsion test.....	43
4.5.1 Twist-off test.....	43
4.5.2 Test description.....	43
4.5.3 Author’s comment, “Slant Twist-off Test”	44
4.6 Tests with indirect tension.....	50
4.7 Comparison of test methods	52
4.7.1 Comparison between shear and tensile bond strength.....	52
4.7.2 Experimental studies on comparison of methods results	53
5. Summary and conclusions.....	58
5.1 Test methods discussion.....	58
5.2 Other test developments for bond determination	59
BIBLIOGRAPHY	60

Abstract: *Good bond strength between overlay and substrate is a key factor in performance of concrete repairs. This thesis was aimed at studying the evaluation of bond strength between repair material and substrate at the interface. Many factors such as surface roughness, existence of micro cracks, compaction, curing etc influence the bond strength. The quality assurance of the bond strength requires test methods that can quantify the bond strength as well as identify the failure mode. There have been numerous investigations led to development of different test methods. The forces which are applied in each test and the failure mode are important in order to choose the proper test. An interpretive study on test methods is presented. While this study can provide individually useful information on bond strength and bond characterization, it also contains discussions about each test and comparison of test methods.*

1. Introduction

1.1 Background

Concrete repairing mainly includes removing unsound concrete and replacing it with repair or overlay materials. One of the key requirements for any kind of repair system is to have adequate bond strength between the existing concrete substrate and overlay throughout the service life. When a repair is performed, the differences in the properties of two materials will affect bond strength and stress distribution. Of particular relevance are differences in shrinkage, elastic modulus and thermal movement.

The repair system can be considered as a three phase composite system: substrate, overlay and bond zone. Bond zone here refers to the interface and vicinity of bond plane. The bond zone must be capable of withstanding the stresses imposed on the system. Different factors have effects on the bond strength and its integrity.

The quality assurance of bond strength requires test methods that can quantify the bond strength as well as identify the failure mode. There have been numerous investigations led to development of different test methods. The forces which are applied in each test and the failure mode are important in order to choose the proper test. Tests are defined both in laboratory and field. An interpretive study on test methods is presented which classifies and compares the tests based on the applied force, failure mode and practical importance of each test.

As the failure modes are either in tension or in shear, two test methods are more applicable; first one is “Pull off test” which is a tensile test and it can be performed both in situ and in the lab. The simplicity and accuracy of the test has made it the most popular test method in projects. The second one is “slant shear test”, which has the shear failure mode and it can be done only in the lab. The so called Twist off test is a relatively new test method to appraise the bond strength in the interface. The advantage of the test is the possibility to perform it in the construction site. The test still needs further developments.

1.2 Objectives

This study was aimed at covering the following parameters:

- The importance of bond strength in concrete repair projects
- Various factors influencing interlayer bond strength at the interface of the concrete repairs
- Various test methods to determine the bond strength
- Discussions and comparison of test methods

1.3 Scope

This study focuses on evaluation of bond strength between repair material and substrate at the interface. After general preview about concrete repair projects and shotcrete as an appropriate repair material, the factors which influence bond strength have been discussed. All the accepted test methods for evaluation of bond strength have been analyzed. The study also contains discussion about twist off test and comparison of all test methods.

2. Repairing of concrete structures

2.1 Introduction

The old way of thinking was to remove the concrete and replace it in case of damages such as cracks, surface discoloration or imperfections. Nowadays there are endless methods to repair the concrete; some of them are mentioned in this chapter. The term “Concrete Repair” refers to any kind of renewing, maintaining and replacing. Regular inspection is a key factor in order to have appropriate repair and maintenance intervals and prolong concrete serviceability. Many investigations indicated that it is economically beneficial to have proper preventive maintenance. Some damages are superficial i.e. cracks while some damages are deep and need fundamental repairs.

2.2 Crack repairs

Hairline cracks, cracks in sidewalks, holes in concrete walls or even small broken corners do not need large scale maintenance. These are mostly due to extra stresses applied to the surface, freezing and thawing, or wearing problems. Normally in these cases simple tools and materials are employed. Crack repairing is done following this procedure (Glenn Smoak, 2002);

- a) cleaning the area, using detergent in case the area is oily
- b) widening and enlargement the cracks by hammer or cold chisel (the crack must be wider at the bottom than at the top, this is called undercutting)
- c) Removing all loose material and brushing the area
- d) Moistening the area and waiting for evaporation of surface water
- e) using some resins or adhesive and then grouting a Portland cement mortar (all the patch must be filled once)
- f) smoothing and leveling the surface with trowel
- g) curing for some days



Figure 2.1.*Repairing the cracks*

2.3 Concrete fundamental repairs

Below is the step wise manner for bigger scale repairing;

- a) Determination the causes of damage
- b) Evaluation of the damage extension
- c) Evaluation of the need and possibility to repair
- d) Selection the repair method
- e) Applying the repair

The procedure of repairing “fundamental problems” are basically the same as “crack repairing” but the equipments are different, since sometimes there is a need to remove deep and big area or prepare the surface in a particular way. Therefore the volume of the work is larger. The other difference is that in this scale of repair works, the new concrete or mortar needs to be carefully designed. Some special mortars or compounds used in repair projects are: Silica fume concrete, epoxy- bonded mortars, polymer modified concrete, Alkyl-Alkoxy Siloxane sealing compound, resin injections and shotcrete (Glenn Smoak , 2002).

Having a good bond strength and being easy to perform, “shotcrete” is being used more often in repair projects as an appropriate repair material.

2.4 Causes of damages

Concrete may be damaged due to many different reasons of which some of the more important causes are discussed below.

Excess concrete water mix

Excessive water is basically one of the most common problems that cause damages in concrete. It highly decreases the strength and the abrasion and increases the shrinkage and creep. Damages of high water cement ratio are difficult to diagnose since it usually gathers with other problems. The only way to have permanent repair in this case is to remove and replace the new layer instead of the problematic layer, however in some special case sealing compounds and coating the layer with a high solid content mortar can reduce the permeability and increase the strength against thawing and freezing. In addition low ratio also causes damages. Performing the concrete in hot weather sometimes makes the top layer have low water cement ratio therefore the top layer can easily get damages (Glenn Smoak, 2002).

Faulty design or construction defects

Placing the bars too close to the surfaces or corners, lack of adequate contraction joints, slabs with insufficient expansion joints, dimensional errors, finishing defects, improper compaction or curing and many other factors in design and during construction, cause damages of concrete.

Alkali Silica Reactivity (ASR)

Some siliceous minerals, including quartzes and opals, react with water in a high alkaline environment to form silica gel, a material used to absorb moisture. As silica gel swells when it absorbs moisture, the material can cause concrete to crack, and white deposits of silica appear. Figure 2-2 shows the cracks caused from ASR (Fu, 2005).

Deterioration through carbonation

Carbonate exists in the air. Although most of the chemical attacks have effects mostly on the surface, carbonation goes deeper and deeper by the time. It

decreases the PH value of the concrete and thus it influences on passivation of the steel and corrosion can take place.

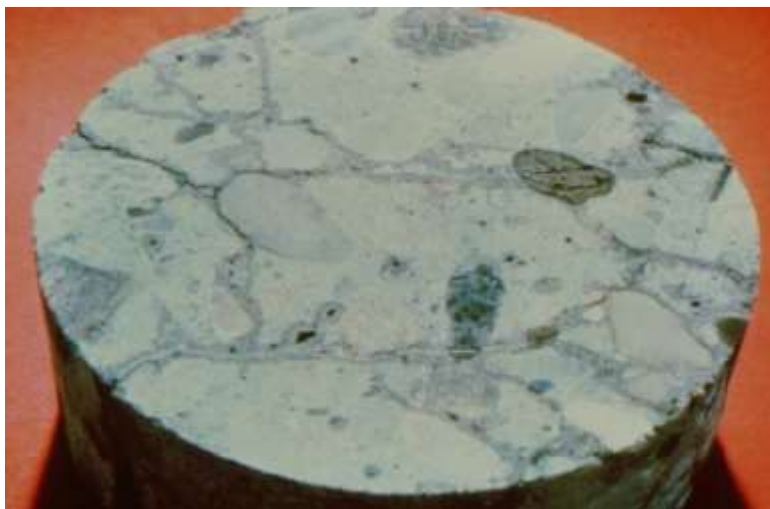

Figure 2.2. *Cracks caused from ASR reaction (Glenn Smoak, 2002)*

Corrosion of reinforcing steel

Corrosion of the reinforcement can be dangerous for whole the structure as they have been designed to carry forces. Corrosion can destroy the bonding between bars and concrete material so the material cannot be able to transfer the loads to the bars in case of corrosion. To fix this problem most of the time it needed to dig the concrete to reach the bars, cover their surface and replace the new concrete (Perkins, 1997).

Deterioration caused by cycle freezing and thawing

This happens when the following situation exists; first the changing temperature for freezing and thawing and secondly the pores in the concrete must be nearly saturated with the water during freezing. More than 90% saturation is needed to reach the condition. The reason is expansion of water and tensile crack development. The best way to repair these structures is to cover the surface or other water affected areas properly with appropriate repair material.

Abrasion-erosion damage

Concrete structure that transports water with silt, sand and rock are faced with this problem. Especially in case that the water velocity is high or the structure is on the slope. Silica fume concrete is the best repair since it has high resistance to abrasion damages.

Structural overload

Damages caused by overload are usually obvious to detect. Normally this might happen once, so for the repair, the common load is considered.

2.5 Shotcrete as a repair material

2.5.1. Background

Shotcrete is a process where concrete is projected or "shot" under pressure using a feeder or "gun" onto a surface to form structural shapes including walls, floors, and roofs. The surface can be concrete, rock, wood, steel, polystyrene, or any other surface that concrete can be projected onto. Shotcrete undergoes placement and compaction at the same time due to the force with which it is projected from the nozzle. It can be impacted onto any type or shape of surface, including vertical or overhead areas, so that shotcrete process is particularly suited for curved or sculpted surfaces. Shotcrete was invented in the early 1900s by American Carl Akeley. He used the method of blowing dry material out of a hose with compressed air, wetting it as it was released. The dry method of creating shotcrete remained in place until the middle of the 20th century, and continued to be refined. By the middle of the 20th century; an alternate method to creating shotcrete was developed. Referred to as the wet method, this process involves using ready-mixed concrete.

2.5.2 Dry mix and Wet mix

There are two basic types of Shotcrete: Dry-mix and Wet-mix.

Still in use today, the dry method involves placing the dry mix into a hopper, where the material has been pre-blended. Compressed air conveys material through a hose at high velocity to the nozzle, where water is added. Material is consolidated on the receiving surface by the high-impact velocity. As

the concrete is shot out of the hose, the operator adjusts the amount of water that is added to the dry mix.

In Wet Mix method all ingredients, including water, are thoroughly mixed and introduced into the delivery equipment. Wet material is pumped to the nozzle with compressed air providing high velocity for placement and consolidation of the material onto the receiving surface.

The major advantage of the dry mix is that the water is mixed at the nozzle and can be adjusted by the operator. This makes the mixture easier to apply in overhead applications. The dry mix is preferred when working on a series of small jobs, as it is easier to setup, shutdown and cleanup. The wet mix produces much less dust and can be applied at a much faster rate than the dry mix. The wet mix also has less waste and less rebound so it is more economical. Nowadays it is more common to use the wet mix unless in exceptional cases.

2.5.3 Shotcrete application

Shotcrete has a wide range of usages; casting new structures, swimming pools, sculpting waterscapes, lining tunnels and ditches, paving slopes and complex shapes such as skateboard parks and earth retaining structures, strengthening and repairing existing structures of all types, providing fireproofing and chemical protection to steel, and construction of tanks, basement walls (underground parking facilities) and any other place that cannot be formed and poured. During recent decades, technical advancements in shattering equipment, concrete technology, and application methods have contributed to the growth of shotcrete as a primary support element in tunnel and mine applications (US army code, 1993).



Figure 2.3. *Shotcrete application in lining of the tunnel*

2.5.4 Shotcrete benefits in repair projects

Shotcrete has high strength, durability, low permeability, excellent bond and limitless shape possibilities. These properties allow shotcrete to be used in most cases as a structural material. Shotcrete is self compacting, because normally with the pressure of the gun it compacts at the surface. Although the hardened properties of shotcrete are similar to conventional cast-in-place concrete, the nature of the placement process provides additional benefits, such as excellent bond with most substrates and instant or rapid capabilities, particularly on complex forms or shapes. US army code EM 1110-2-2005, mentions that “Both shotcrete mixtures often provide significantly higher bond strength to existing materials than does conventional concrete”. Shotcrete can be aimed and applied to surfaces at any angle, including overhead. Because forms are not required, shotcreting is a cost-effective method for repairing vertical and overhead surfaces. Adding some additions such as silica fume or different kinds of fibers can highly improve the shotcrete characteristics as well as bond strength.

2.6 Importance of bonding in concrete repairs

After repairing the concrete structure and replacing a new layer, there should be enough strength in both layers since the damaged part of substrate has been already removed and the new layer has been designed and placed according to the requirements of the work. Despite having adequate strength in both layers, the interface is still vulnerable to damages and could be the most sensitive part of the system.

Two layers have different modulus of elasticity, so exposed to the same load each shows different strains. The interface should be able to bear this difference. The same problem exists for the temperature strains. In addition the new layer has shrinkage which is considered as another factor for interface weakness. Since the interface is the plane of discontinuity in the system, it exposes to all these extra forces and it should have enough resistance to hold the integrity of the layers. Thus a key requirement of a repair material is to good adhesion at the interface.

There are many factors which have influence on the bond strength and some test methods to figure out the strength and quality of the bond. Next chapters discuss the factors and test methods in details.

3. Bond in concrete

3.1. Definition of the bond strength

The bond strength is the adhesion between overlay and substrate which can be the weakest link of the system. Good bond strength is a key factor to have a monolithic system (Beaupre, 1999).

Bond can be expressed by shear resistance or tensile resistance. It is important to select the one which can better state the stresses subjected to the structure in the field. While in many cases the stress in the field is of shear type it is more practical to use the tensile strength for bonding in structural works.

In practice the usual way to determine the tensile bond strength is the pull off test, in which the tensile force applies perpendicular to the overlay till the failure occurs. The bond strength can be easily defined as maximum force divided by the interface area, in the condition that failure occurs completely at the interface. Failure in the substrate indicates that the bond strength is greater than the tensile strength of substrate and a failure in the overlay indicates that the bond strength is greater than the tensile strength of the overlay (Bonaldo et al., 2005).

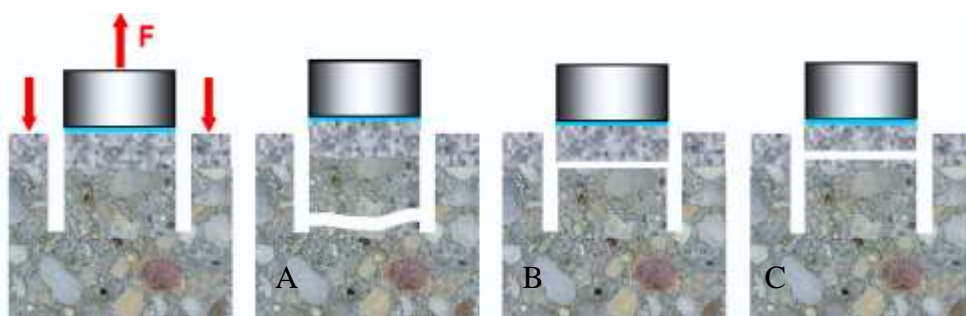

Figure 3.1. A) Failure in substrate, B) Bond failure, C) Failure in overlay
(Brochure of German Instruments Co.)

Normally in repair works failure in the substrate is preferred, since it shows the overlay has been done properly. Figure 3.1 shows the three different failure types in the system.

3.2. Main factors influencing bond

3.2.1 Cleanliness

A bond surface must be free of dust, oil, grease and other contaminants. These have significant influence on the bond strength if remain. They decrease the friction and make the preventive layer for interlock between substrate and top layer. Dusts can be blown off easily but there are some difficulties to clean the oil or grease from the surface (Austin et al., 1995 and Silfwerbrand, 1990).

3.2.2 Surface preparation

3.2.2.1 Removal and Micro Cracks

In order to gain proper bond strength the surface must be prepared prior to performing the overlay. In the repair works when the substrate is concrete before surface preparation the deteriorated concrete must be removed since it may damage the new layer and it does not have enough strength. It is also recommended when the substrate is rock, to remove the layer of chemically or mechanically damaged rock before surface preparation.

There are several methods to prepare the surface. And it is quite important to choose the best way since it has a decisive influence on bond in the interface.

Some methods can only remove a thin layer of concrete, while others have the ability to remove material to a significant depth. It is important to take into consideration that if the surface produced by a vigorous method, i.e. hammering, the surface will be very rough but micro cracks will be induced just beneath the prepared surface, making it weak (Silfwerbrand, 1990 and Talbot et al. 1994).

Micro cracks reduce bond strength substantially and they have a detrimental effect on the uppermost layer of the substrate. Micro cracks cause reduction in the effective bond area. Also micro cracks develop due to the stress concentrated at their tips.

Some of the most frequent methods for surface preparation have been summarized in Table 3.1. Figure 3.2 and Figure 3.3 show the surface prepared with some of the methods.



Figure 3.2. A) Substrate surface partially chipped, B) Substrate surface prepared with steel brush (Julio et al., 2004)

Table 3.1. *Methods of concrete removal (Silfwerbrand, 1990 and Courard, 2006)*

Removal method	Principle behaviour	Important advantages	Important disadvantages
Sand-blasting	Blasting with sands.	No microcracking.	Not selective, leaves considerable sand.
Scrabbling	Pneumatically driven bits impaction	No microcracking, no dust.	Not selective.
Shot blasting	Blasting with steel balls.	No microcracking, no dust.	Not selective.
Grinding (planning)	Grinding with rotating lamella.	Removes uneven parts.	Dust development, not selective.
Milling (scarifying)	Longitudinal tracks are introduced by rotating metal lamellas.	Suitable for large volume work, good bond if followed by water flushing.	Microcracking is likely, reinforcement may be damaged, dust development, noisy, not selective.
Pneumatic (jack) hammers (chipping), hand-held or boom-mounted	Compressed-air-operated chipping	Simple and flexible use, large ones are effective.	Microcracking, damages reinforcement, poor working environment, slow production rate, not selective.
Explosive blasting	Controlled blasting using small, densely spaced blasting charges.	Effective for large removal volumes.	Difficult to limit to solely damaged concrete, safety and environmental regulations limit use, not selective.
Water-jetting/hydro demolition	High pressure water jet from a unit with a movable nozzle	Effective (especially on horizontal surfaces), selective, does not damage reinforcement or concrete, improved working environment.	Water handling, removal in frost degrees, costs for establishment.



Figure 3.3. Substrate surface treated with sand blasting (Julio et al., 2004)

Although mechanical methods i.e. hammers are likely to introduce micro cracking, field tests however have shown that the bond strength can reach satisfactory values if mechanical removal is followed by high pressure water cleaning.

Based on tests that have been done by J. Silfwerbrand (1990) water-jetting is one of the best solutions both having the high roughness and not having micro cracks. Courard (2006) compared the micro crack length for jackhammers and water jetting; the result indicates a significant decrease in the micro crack lengths by using water jet technique (Figure 3.4).

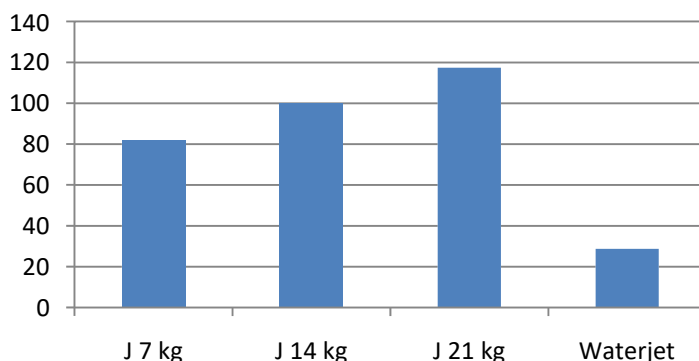

Figure3.4. Micro-cracks length (mm) for jackhammers and water-jetting (Courard, 2006)

3.2.2.2 Surface Roughness and Micro cracks

The surface roughness is important to provide friction and aggregate interlock but Silfwerbrand proved that roughness in its own does not have significant influence but the method of surface preparation and the absence of micro cracks is more important (Silfwerbrand, 1990).

Table 3.2. Pull-off test results for different surface treatments (Julio et al., 2004)

	Substrate Surface preparation type	Bond strength in tension (MPa)	Variation coefficient (%)
1	Wire brushing	1.92	13.54
2	Partially chipped	1.47	7.48
3	Partially chipped and pre wetted	1.02	12.75
4	Sand blasting	2.65	6.42

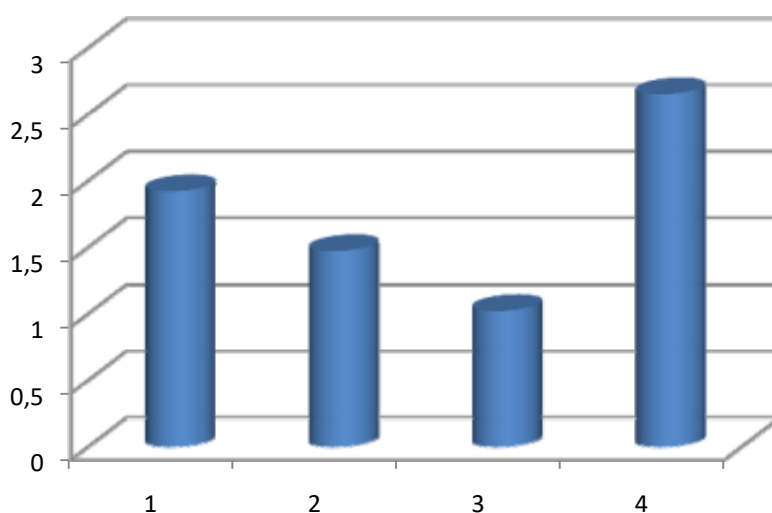

Figure 3.5. Pull-off test results for different surface treatments (Julio et al., 2004). There is an increase around 250% in bond strength when surface is prepared by sand blasting instead of pre wetted and partially chipped, which can show the importance of the surface preparations.

Table 3.2 and Figure 3.5 show results from the pull-off test of specimens with four different surface preparations (Julio et al., 2004); there is an increase around 250% in bond strength when the surface is prepared by sand blasting instead of being pre wetted and partially chipped, which can show the importance of the surface preparations.

3.2.2.3 Rebar and reinforcement cleaning

According to Silfwerbrand (1998), the interface between substrate and shotcrete should not coincide with the reinforcement plane because it may affect bond durability under cycle loading. And if the shotcrete is performed on the other shotcrete layer which has rebar, the rebar must be clean and the distance between rebar and substrate must be more than maximum aggregate size of the overlay plus 5mm. All the bars and reinforcements should be cleaned from dust and **corrosion**.

3.2.2.4 Cleaning after removal

After cleaning and preparing surface once with the methods discussed before, second cleaning has to be carried out prior to overlay placement in order to make sure that the surface is free from dust, oil or any particles from construction works. The recommended method for second cleaning is high pressure water (Silfwerbrand, 1990).

3.2.3 Laitance

Laitance refers to a layer of weak nondurable material containing cement and fines from aggregates, brought by bleeding water to the top of over wet concrete. Laitance may be detected by scraping the concrete surface with a putty knife; if a quantity of loose powdery material is observed or easily removed, excessive laitance may be considered to be present.

Absence of laitance is considered as one of the major factors for cases in which substrate are concrete. If the laitance is not removed it will lower the bond markedly. One of the sufficient ways to remove the laitance is sandblasting.

3.2.4 Compaction and placement of the overlay

Compaction is an important factor for obtaining a dense and homogeneous overlay as well as a good and even bond. Compaction helps the overlay fill and cover cavities and voids at the surface which means to have more efficient contact area and fewer caves. The other advantage is to have better and less permeable overlay which is also helpful for durability of the bond. On rough and uneven surface, there is a risk for air pockets in the depressions of the surface (Silfwerbrand, 1990).

Shotcrete has enough compaction due to the high pressure spraying process; however it is important to spray it skillfully to achieve a good result. Compaction of the concrete can be done with the vibrator poker and vibration platform in the construction sites.

Compaction stages

Compaction is the process which expels entrapped air from freshly placed concrete and packs the aggregate particles together, so the first apparent effect of compaction is to increase the density. Compaction also increases significantly the ultimate strength, bond strength, abrasion resistance and general durability of concrete. Compaction decreases the permeability and minimizes the shrinkage and creep in concrete.

Compaction consists of two stages (Figure 3.6), the first stage is to compact the concrete in order to allow it to slump and fill all the forms. The second stage is the expulsion of entrapped air. The compaction finishes when there are no longer bubbles on the surface (Cement concrete and aggregates Australia, 2006).

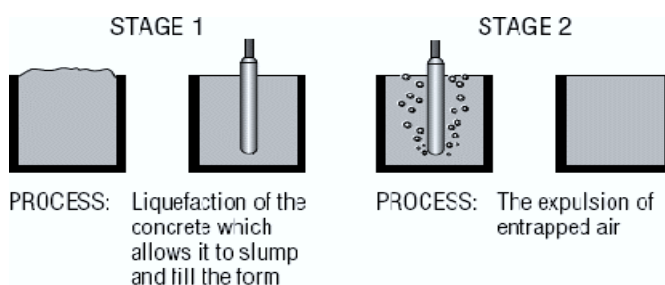

Figure 3.6. Compaction stages, Stage 1) Liquefaction of the concrete which allows it to slump and fill the form, Stage 2) The expulsion of entrapped air (Cement Concrete and Aggregates Australia, 2006)

Figure 3.7 shows the dramatic influence of incomplete compaction and existence of air voids in the concrete, for instance the concrete which has around 15 % of air voids has only 30% strength of the fully compacted concrete (Cement concrete and aggregates Australia, 2006).

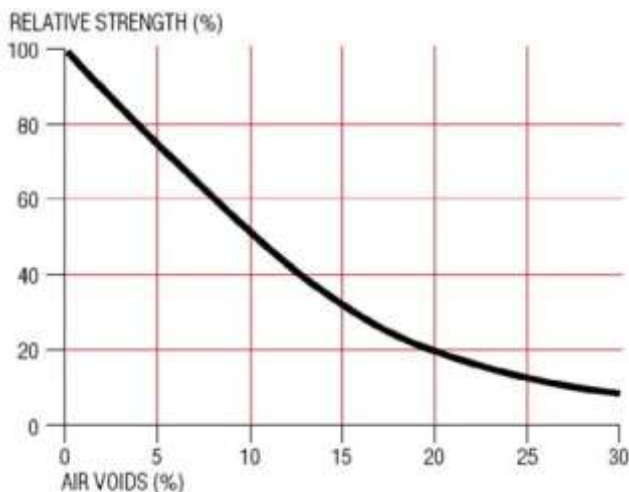

Figure 3.7. Loss of strength through incomplete compaction. (Cement Concrete and Aggregates Australia, 2006)

Methods of vibrating compaction

There are different types of compaction of concrete, with different equipments, depending on the type of the concrete, the volume of the work and project demands. But for many repair works compaction using vibrators are more common. On the construction site there are two main types of vibrators; immersion vibrators and surface vibrators. In some projects both of them are used after each other. There is also another type called form vibrators which is mostly used in precast works.

Immersion vibrators

Immersion vibrators also known as ‘poker’ or ‘needle’ vibrators are tubular housing which have a rotating eccentric weight. The radius of action varies from 100 mm to 600 mm depending on the diameter of the vibrator and amplitude of vibrating. These vibrators should be quickly inserted into concrete and should be held for several seconds until the bubbles cease to rise on the surface. Compaction should be done with a regular pattern otherwise there might be some parts that

remain uncompacted. High slump concrete, thin members and construction joints need to be compacted with smaller radius of action while mass concrete or low slump need to be compacted with larger radius of action.

In repair works when new concrete has to be placed in the corners i.e., inclined forms or stop-ends, it is better to place it a little away from the corner and with immersion vibrator concrete can move the corner. It should be noted this does not mean to flow the concrete with the vibrator. This is to avoid destroying the mixture by vibrating it in the corner.

Surface vibrators

Surface vibrators are applied to the surface; they are used to compact slabs, surfaces, industrial floors, road pavements, etc. different types of them are being used. Vibrator-roller screeds, vibrating-beam screeds and pan-type vibrators are more common.



Figure 3.8.*Typical surface vibrator.*

3.2.5 Overlay curing and temperature effect

Curing is the process of controlling the rate and extent of moisture loss from concrete during cement hydration. Since the hydration of cement does take time, days and even weeks curing must be undertaken for a reasonable period of time if the concrete is to achieve its potential strength and durability. Concrete strength depends on the growth of crystals within the matrix of the concrete. These crystals grow from a reaction between Portland cement and water, a reaction known as hydration. If there is not enough water, the crystals cannot grow and the concrete does not develop the strength it should. Effect of curing duration on compressive strength development is presented in Figure 3.9 (Kosmatka et al., 2002). Figure 3.10 illustrates the effect of different periods of water curing on the permeability of cement paste. As may be seen, extending the period of curing reduces the permeability (Cement concrete and aggregates Astralasia, 2006).

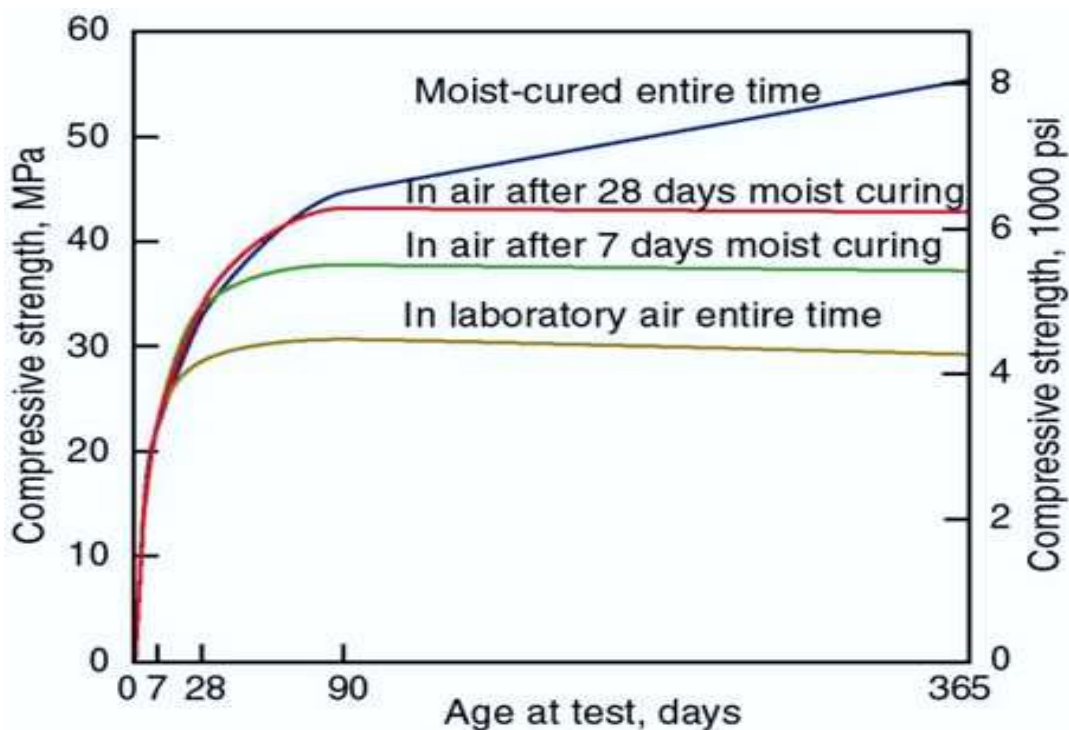

Figure 3.9. Effect of curing duration on compressive strength development (Kosmatka et al., 2002).

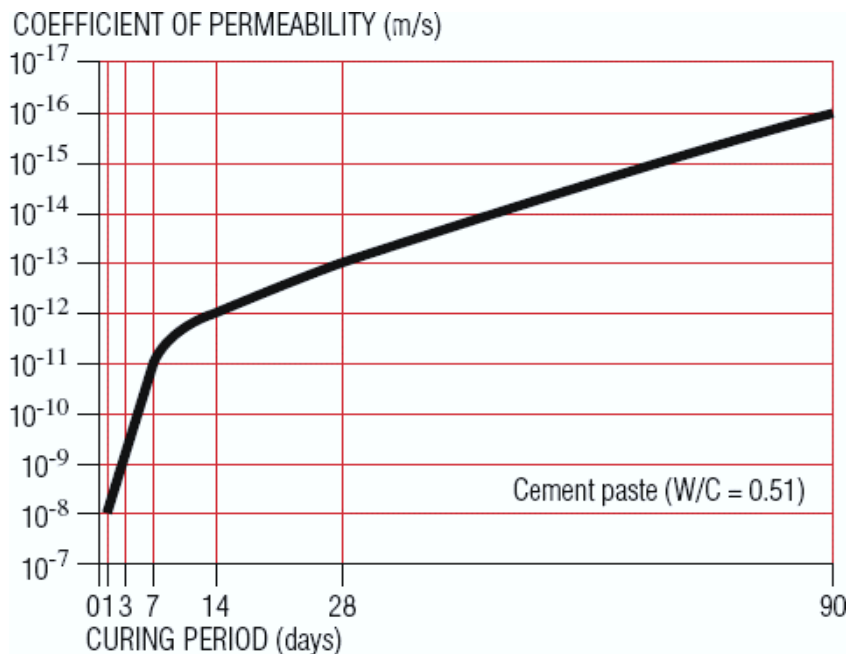

Figure 3.10. Effect of curing duration on permeability of cement paste (Cement concrete aggregates Australia, 2006)

The other important aspect of curing is temperature; the concrete must not be too cold or too hot. As fresh concrete gets cooler, the hydration reaction slows down. Hot concrete has the opposite problem: the reaction goes too fast, and since the reaction is exothermic and produces heat, it can quickly cause temperature differentials within the concrete that can lead to cracking. And cement that reacts too quickly does not have time for the crystals to grow properly so it does not develop as much strength as it should. So the objective is to keep the young and impressionable concrete damp at the right temperature. In construction projects the problem is more common with too cold weather rather than hot weather though, for example in some tunneling projects.

It is important to know that temperature mostly has an influence on the speed and rate of the hydration. Effect of curing temperature on compressive strength development is presented in Figure 3.11 (Kosmatka et al., 2002).

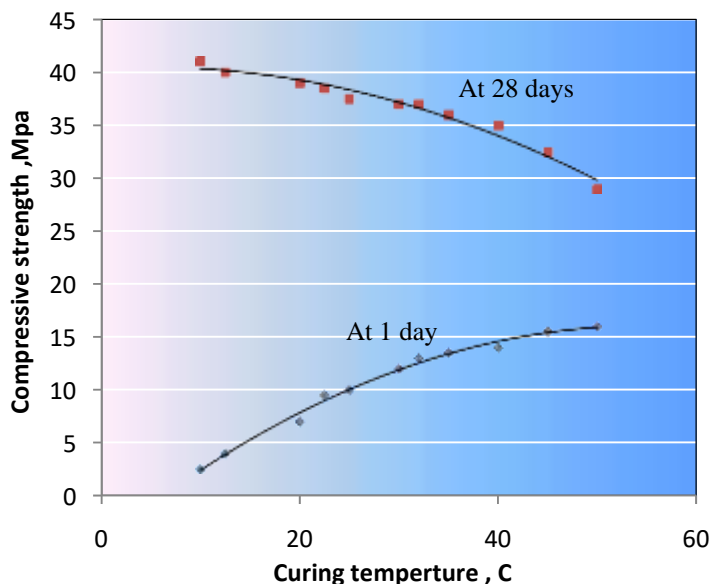

Figure 3.11. *Effect of curing temperature on compressive strength development (Kosmatka et al, 2002).*

Methods of curing concrete fall broadly into the following categories; either to minimize loss from the concrete, for example by covering it with a relatively impermeable membrane, or to prevent moisture loss by continuously wetting the exposed surface of the concrete or to keep the surface moist and, at the same time, to raise the temperature, thereby increasing the rate of strength gain.

Ponding and immersion, spraying and sprinkling, saturated wet coverings and wet covering are some types of water curing. Retention of formwork and plastic sheeting are common types of impermeable curing.

When temperature problems also exist, Live steam, heating coils, Concrete blankets can be used for curing. ACI 306, cold weather concreting, indicates that the preferred technique is steam for both heating and preventing excessive evaporation. Water curing is the least desirable method and it is not recommended since it produces icing problem.

Curing plays an important role in durability of the overlay by reducing the risk of cracks. Curing helps the concrete to gain more and faster tensile strength

and this protects the concrete against cracks caused by early age shrinkage. Fewer cracks mean to have less permeable overlay. Therefore curing can reduce the risk for debonding. Curing has a strong influence on the wear resistance. Surface strength development can be reduced significantly when curing is defective, because the water loss is always larger in the top layer (Austin et al., 1995).

3.3 Secondary factors influencing bond

3.3.1 Overlay properties

Of course the properties of cementitious material in the overlay influence the bonding condition in the interface. The amount of cementitious material has direct effect on adhesion between layers, hence adding “silica fume” to shotcrete can significantly increase the bond strength. This is basically known as one of the best ways to increase the bond (Austin et al., 1995 and Momayez et al., 2004).

Adding steel fibers to shotcrete does not have direct influence in the interface, since the fibers are distributed in the overlay and they are not able to involve with substrate.

Adding fibers make the shotcrete more porous and could have effects on permeability of the shotcrete. Therefore small cracks occur in the fibers shotcrete. Since cracks are one of major problems in the interface, the bond durability is longer when overlay has fewer cracks.

The addition of polymer to cementitious overlay mortars was found to result in better bond characteristics on specimens subjected to extensive temperature cycles (Atzeni et al., 1993). The addition of short carbon fibers can significantly increase the shear bond strength (Chen et al., 1995).

The workability of the mixture influences the ability of good compaction and also it helps the mixture to fill all the voids and cavities of the interface thus it increases the so called effective contact area in the system. In the case of shotcrete the compaction is normally performed properly by the pressure.

The permeability of the overlay may cause less durability by letting the moisture migrate through the bond surface.

The mechanical characteristic of the overlay is also another factor that plays a role in bonding strength of the interface. While the compressive strength of the overlays does not influence the bond significantly, the tensile strength is important and it can control crack development.

3.3.2 Pre wetting

The moisture condition has influence on bonding strength and failure mode. The moisture condition of both the surface and the substrate is important. If the surface and substrate are too dry, part of mixing water of the top layer will be absorbed by the substrate before any components in a cement paste are formed. This causes a risk for heterogeneous and porous zone close to the bond surface. If the surface and substrate are too wet and saturated, the capillary pores in the substrate are filled and therefore the excess water will rise up to the surface and it make a layer with high water cement ratio (Austin et al., 1995).

It can be concluded that the result of too dry or too wet surface is always weakness of the bond strength. Tests carried out by Simon Austin and Peter Robins (1995) showed that the best result is when the substrate is saturated and the surface is dry, saturated surface dry (SSD).

3.3.3 Time

The effects of time on the bond strength should be taken into consideration during two periods. One is after casting the overlay, when the hydration in the overlay is finished, “short term bond properties”. The other one is long term bond properties, which is during the service life of the structure, when the shear stresses, temperature differences, and other forces might have negative effects on the bonding.

3.3.3.1 Short term bond properties

Early age bonding between overlay and substrate is improved by time as well as other characteristics of the concrete such as compressive strength, tensile strength and shear strength. The bond strength develops rapidly after placement of

the overlay. The increase is due to the hydration in the overlay. Some tests carried out by Silfwerbrand 1998 have shown that the development rate is even faster than the hydration rate in the overlay so it is understandable that the bond strength development was found faster than the development of compressive strength. The increase of shear strength is closely related to the increase rate of compressive strength (Silfwerbrand, 1990). Due to the temperature and moisture exchange in the edges, bonding increases more in the centers first.

3.3.3.2 Long term bond properties

Differential movements between substrate and overlay, normally due to shear force, temperature and shrinkage, are the most important items affecting the long term bond strength. Generally the durability of the bond depends more on the overlay durability, external forces and environmental effect rather than the high initial bond strength.

3.4 Other factors influencing bond

3.4.1 Traffic vibrations

Generally traffic vibrations do not cause damages on the bond surface as well as the fresh concrete in the overlay and it can even help concrete to compact more. The researches show that continuous but “limited” vibration can increase the strength of the concrete both in the bond surface and overlay.

Of course the heavy vibration and traffic can be harmful for newly cast overlay.

Although the vertical vibrations due to the traffic in some structures such as bridge decks or concrete pavements can be useful, but in tunnel blasting the vibrations do not play a positive role since vibrations which come from explosions in the vicinity are normally heavy and the waves are both vertical and horizontal. So that they cause shear forces in the interface make the early age bond weak (Silfwerbrand, 1990).

3.4.2 Bonding agent

Bond agents can increase the bonding strength in special cases. For example when the chosen overlay cannot properly fill all the holes and pores of the interface. Bond agents could be Portland cement mortars or modified latex or epoxy resins.

But in general bond agents are not recommended (Silfwerbrand, 1990 and 1998). First because the bond agent creates two interfaces which means two possible weakness planes. Secondly, since bond agents are grouts with high water cement ratio, less strength at the interface is provided by them.

3.4.3 Environmental factors

Environmental factors such as temperature, temperature changes, thawing and freezing, humidity can influence the bond durability. An aggressive environment indirectly has a negative effect on bond strength. It makes difficulties especially for curing and later during the service time. The environmental factors have more influence as the structure starts to have partial weakness or cracks. The chemicals in the rain or water, existence of sulfates, hydro Chlorate, phosphate etc increase the risk of undesirable reactions in cement or aggregates. If the overlay includes bar or reinforcement there might be a risk for corrosion due to the humidity.

Choosing proper cement and aggregate type compatible with the environment condition, appropriate curing and compaction, suitable mix properties of the overlay are some items which can protect the overlay and bond surface against the unfavorable environmental conditions.

3.4.4 Mechanical device crossing the interface

In special cases when high shear strength, or higher safety margin against debonding is needed, some reinforcement has to be installed. These

reinforcements cross the interface and has to be anchored properly both in overlay and substrate. As ordinary reinforcement, this reinforcement does not carrying load until the bond is broken.

Although the bars and reinforcements crossing the interface can be an advantage in case of surface debonding, any mechanical device crossing the interface needs enough considerations for installation and maintenance in order not to cause damages in the structure.

4. Test methods to evaluate bond strength

4.1 General classification

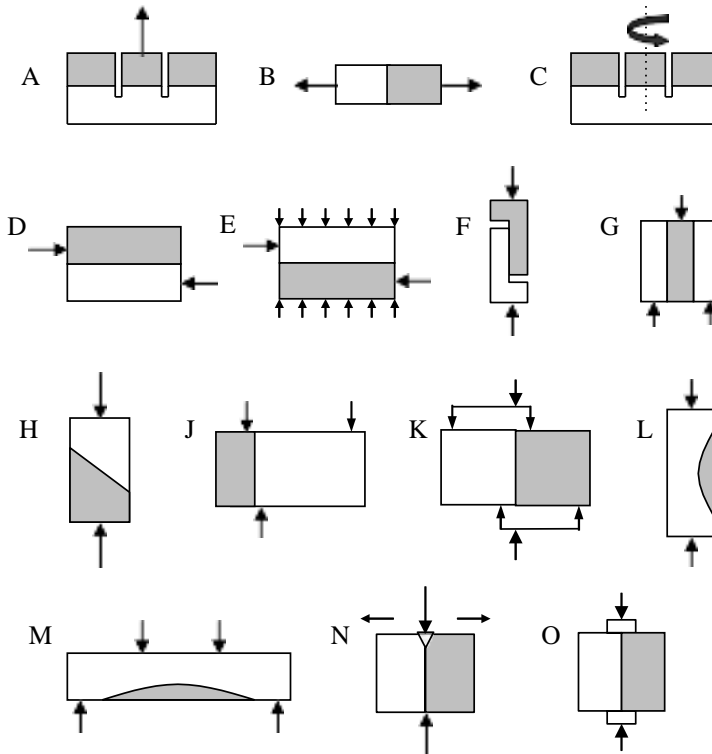

Figure 4.1. Various test methods to evaluate bond strength at the interface (Silfwerbrand, 2003)

Many tests have been developed to evaluate the bond strength in the interface. Figure 4.1 schematically shows test methods related to interface bond. While some of the methods are not so common in projects, some others like “pull-off test” or “slant shear test” are more common and used extensively in projects. Most of the standards and codes confirm these two tests. Less problems and shortcomings, being easy to set up and perform, wide range of applications and the reliability of the results are the main reasons why these two tests are more accepted. Considering the importance of these two methods, “Pull-off Test” and “Slant Shear Test” have been discussed in more details in this chapter.

Author divides bond tests into five categories based on the state of stress imposed to the interface and the type of force applied in the test; direct tensile tests, compression-shear test, shear tests, torsion test, and indirect tensile tests. In order to define each category a brief review of concrete failure modes is needed.

Figure 4.2 shows a small point in a solid which is under stress in the x and the y directions. These plain stresses can be shown with the Mohr Circle. Introduced by Otto Mohr in 1882, Mohr's Circle shows principal stresses and stress transformations via a graphical format.

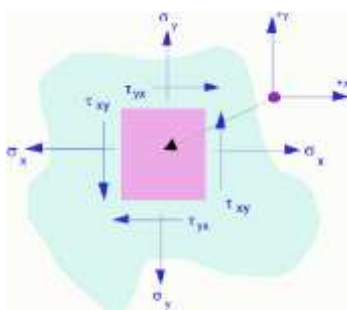

Figure 4.2. *Element under stresses*

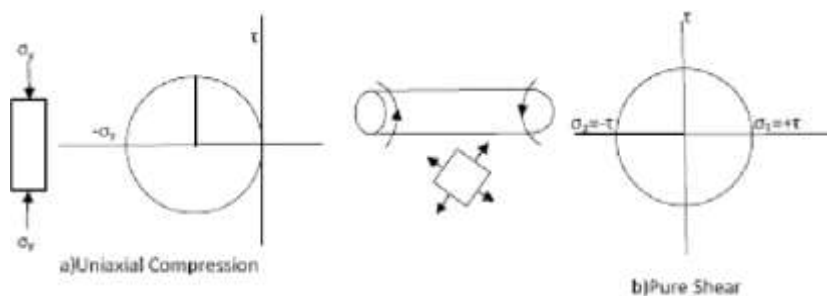

Figure 4.3. *Element under uniaxial compression and pure shear*

Mohr's Circle can be used to find stresses in different elements and angles. Figure 4.3 has shown elements under uniaxial compression and pure shear stresses and their related Mohr circles. Combining the failure envelope of a material and the stresses on the Mohr circle, it could be easier to understand the failure modes and the types of stresses needed for a specific material to meet the failure criteria.

Figure 4.4 represents the typical failure envelope of the concrete as a brittle material in the plane states of stresses. According to the failure types the different test methods can be classified; the aim of each test method is to apply certain stresses in the certain directions to approach the failure and measure the failure stresses. It is important to place the bond surface in the correct angle in which the failure might happen.

In tensile tests the tension stress or force is applied to the specimen. As it can be found in the figure 4.4, the failure in tension occurs in the plane perpendicular to the specimen's cross section, so in the tensile bond test i.e. pull-off test the interface is placed perpendicularly to the tension force direction (Figure 4.1. A). Unlike the tensile failure, the failure under compression occurs in the plane which has an angle around 30° with the compression force direction. To be able to find out the bond strength in the compression-shear type test such as slant shear test, the interface is placed with the angle close to the probable angle in which failure might happen (Figure 4.1. H). This means that if a compressive force applies to the concrete which has integrity, the failure cracks will be in the plane with similar angle as the angle chosen in the test.

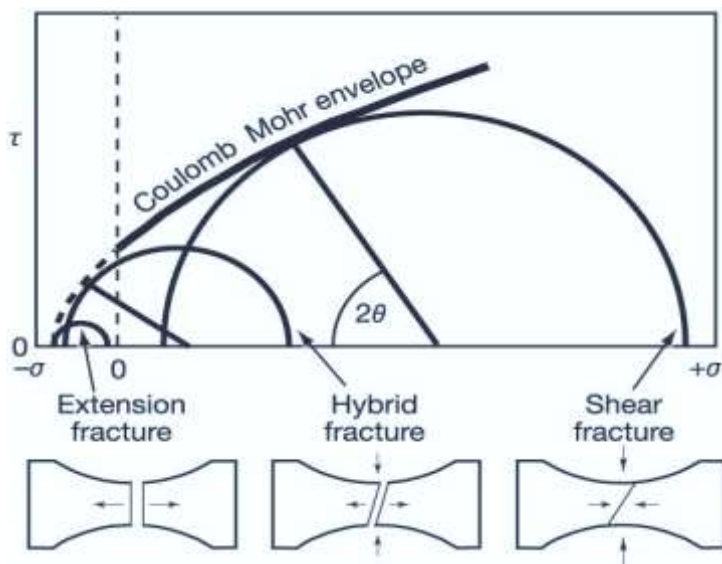

Figure 4.4. Failure envelope of the concrete (Ramsey and Chester, 2004)

Torsion test also known as twist-off test, indirect tension and shear tests have the hybrid mechanism, as it has been shown in figure 4.4. Specimens are exposed to shear, tension and compression in these tests.

Although in most bonding tests crack appearance is basically due to the shear stresses, this classification could be useful to illustrate the test methods. It should be mentioned that here compression-shear test refers to test in which the specimen and not the interface is under compression. Because in the slant shear test the interface is inclined so it exposes to a combination of shear and compression at the same time.

Therefore the bond strength achieved from different tests might have different values because each has considered especial stresses and failure mode, but in general there is a correlation between results (Silfwerbrand, 2003 and Delatte et al. 2000a). Each test could also lead to relatively different outcomes based on the test performance, set up, size of the specimen, loading rate, etc. Studies regarding the specimen's size effects on the bond strength have shown that the smaller specimens generally have larger bond strength (Li et al., 1999). Figure 4.5 shows the stresses and failures in some different tests methods.

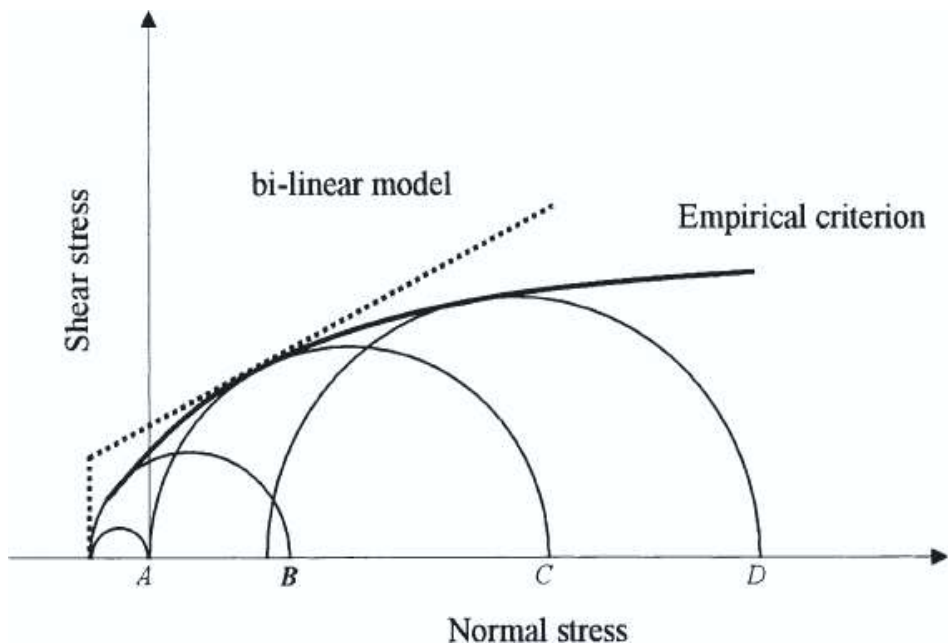

Figure 4.5. Mohr's circle from A: direct tension B: Brazilian test C: unconfined compression, D tri axial compression tests (Austin et al., 1999).

4.2 Tensile tests

The tensile test method for evaluating the bond strength is the pull-off test which can be carried out both in-situ and in the lab. One of the advantages of this test is the possibility to perform it on the construction site. This means saving the time and it could also be financially beneficial. The most important factor that has to be considered in the pull-off test is to avoid the eccentricity. The eccentricity can highly influence the result and make it unreliable (Delatte et al., 2000b). Here the in situ pull-off test has been explained; the same procedure could be carried out in the lab (Figure 4.1 A and 4.1. B).

4.2.1 Pull-Off test

The Pull-Off test is a popular tensile bond test; the simplicity of this test and the possibility to do it both in field and in lab are the main reasons (Austin et al., 1995). Studies undertaken at Queens University in United Kingdom were the first development of the pull-off test (Long and Murray, 1984). Later Austrians, Stehno and Mall 1977, were proponed the concept which they called it tear-off test. In 1991 Mathey and Knab studied the bond in the interface by using uniaxial tensile tests which was the in situ pull off test with partial coring. Tests were done with two types of instruments; one of them using a hydraulic apparatus and the other with pneumatic one.

These studies led to the development of the pull off test in which core were drilled first and then a steel disk glued on the core with the strong and quick epoxy, loading to reach the failure and at last measuring the load. The test equipment started being commercially available and has been used for a wide range of projects.

Afterward, to achieve further developments, many studies were undertaken about the factors influencing pull-off tests by using experiments and also numerical and analytical methods (Bungey and Mandandoust, 1992). Thickness and diameter of the disk, the length of core, diameter of the core, the type of material in the layers, usage of bonding coat, etc were some of the factors conducted in experiments.

4.2.2 Test Procedure

Although there are some alterations in the equipments and methods, the general procedure of in situ test can be described as follows; figure 4.6 and 4.7 show the schematic pull off test procedure and equipment.

a) Pointing and Marking the area

b) Surface planning

Preparing the surface with the diamond wheel to obtain a plane surface should be done. Dusts and any powders on the surface remaining from planning the surface with diamond should be brushed and blown away. The corner knob should be removed with a grinder.

c) Attaching the disc to the core

The clean metallic core is glued to the surface using epoxy. The epoxy is high strength and quick setting; it can have tensile strength around 10 MPa when it is fully cured. The curing can be accelerated using heat gun. It usually takes 2 to 5 minutes for the glue to be hardened.

d) Partial coring, the core should be cut perpendicular to the surface and the core should pass the interface around 1 inch or 25 mm. The disc is used as a drill guide.

e) Attaching a load frame to the disc

f) Pulling off

Direct tension is applied to the disc. A calibrated hydraulic machine can be used. The tension force increase continues until the specimen fails. The failure mode and failure force are recorded.

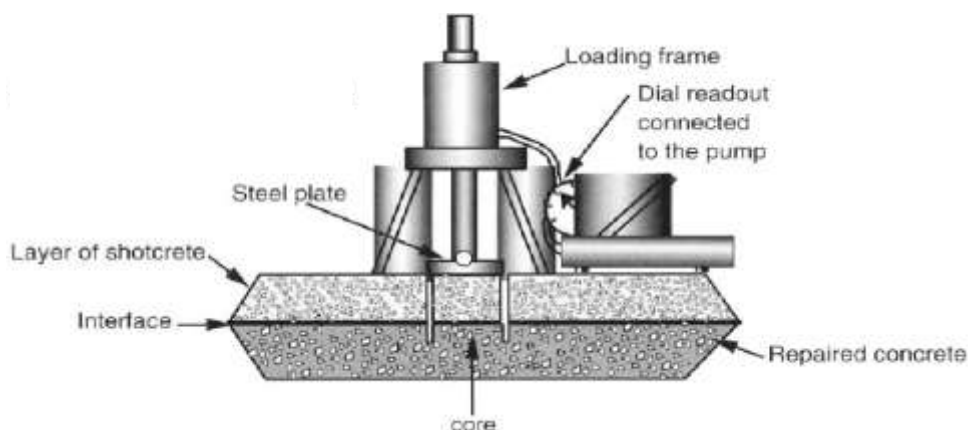

Figure 4.6. Pull-off test procedure (Beaupre, 1999)

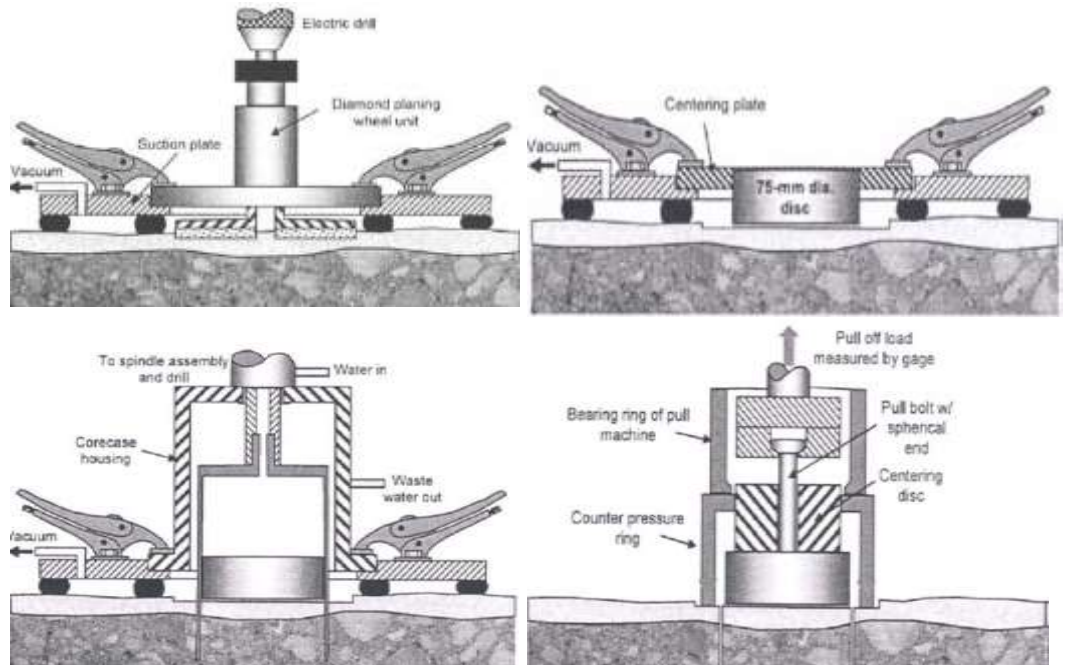

Figure 4.7. Pull-off testing procedure; surface preparation, disc attachment, partial coring, pulling off (Brochure of German Instruments Co.)

Although little standardization has yet happened, the pull off test is a favored test in many codes. In the British Standard BS 1881 : Part 207(1992) the guidelines indicate that the center of coring should be at least one core diameter away from the edge and two core diameter from the other cores. Six valid tests are sufficient for a specific area according to BS. The BS loading rate is 0.05 ± 0.03 MPa per second. The coefficient of variation around 10 percent is acceptable. The European Standard indicates that the core should be drilled one inch into the substrate.

One of the disadvantages of pull off test is high sensitivity to eccentricity. The other problem is about the forces which are involved in this test. In many structures the repair layer is under complex stresses mostly with shear, but this test is under sole tension. This means ,the test does not simulate the exact situation of the structure in many cases but still it can show the quality and strength of the interface bond for some special cases for example the boundaries of the member in which tension is predominant, it is highly recommended to apply this test.

4.3 Compressive-shear test

It should be mentioned that here compression-shear test refers to the test in which the specimen and not the interface is under compression. Because in the slant shear test the interface is inclined so it exposes to a combination of shear and compression at the same time.

4.3.1 Slant shear test

One of the most common types of bonding tests is “Slant Shear Test” in which the interface is under combined state of compression and shear stresses. This test was first presented in the form of “Arizona Slant Shear Test” (Kreigh, 1976) and later after some developments was standardized in British Standard, BS 6319: Part 4 for testing the repair materials. ASTM C882-99 also provides the procedure of bond measurement with the same test method. Wall and Shrive (1998) modified the test by using prism with the length three times the cross section dimension instead of the cylinder. As in many cases the real stresses in structures have the shear component, this test is representing the situation more close to the construction site.



Figure 4.8. *Slant shear test (Momayez et al., 2004)*

The idea behind the test is the idea for the common compressive strength test. In compressive test, concrete failure happens due to the shear cracks in the incline plane. The angle of failure plane with horizontal direction is theoretically between 50° and 70° (Figure 4.5 C), so 60° could be a proper assumption. Therefore in this test method the interface is placed inclined with the same angle and a compressive force is applied to the system. (Figure 4.8)

4.3.2 Test description

General

The procedure describes the slant shear test method for measuring the bond strength of the interface. The half section of hardened substrate is diagonally cut at 60° from the horizontal and is bonded to the new material, make a complete cylinder. The cylinder is subjected to compression until it meets the failure (Momayez et al., 2004 and Austin et al.1999)

Equipment

- a) A mortar mixer, concrete mixer
- b) Compression testing machine
- c) Equipment to cut the cylinder after curing the substrate
- d) Specimen Molds
- e) Small tools such as tamping rod, brush, trowel etc

Material

The material for substrate and repair are based on the order from site and with consideration of the codes which is being used.

Procedure

- a) Casting the substrate
- b) Curing the substrate
- c) Sawing the substrate at 30° angle from vertical (at least four days of curing needed)
- d) Surface preparation and sandblasting at 14 days
- e) Placing the cylinder out of curing room for at least two days
- f) Checking the 21 days strength of substrate
- g) Placing the repair material

Calculations

$$\text{Bond Strength} = \frac{[\text{Maximum Load}]}{[\text{Area of slant surface}]}$$

It should be noted that the ASTM C882-99 focuses on bond strength of epoxy-resin system. So in ASTM the test procedure is to place two match cylinder halves and bond them with epoxy. But for testing the bond strength of two different materials the second one must be cast after substrate having been cured and prepared.

4.3.3 Problems reported for “Slant Shear Test Method”

Austin and Robins studies (1999) showed that there are some serious shortcomings with the slant shear test. First of all failure is greatly dependent on the angle of the interface. This angle is normally 30° according to the standards (Figure 4.9). The larger angle makes the test result towards the compressive strength because it makes the compressive component to have more influence. (Figure 4-10)

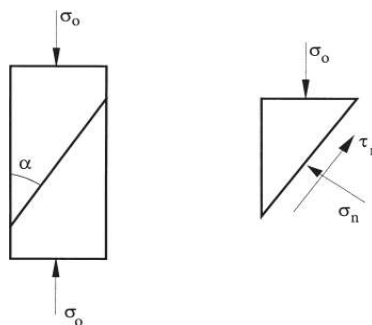

Figure 4.9. *Slant shear test configurations, the forces on the interface are the combination of shear and compression and the proportion depends on the angle (Austin et al., 1999)*

Secondly, the test is relatively insensitive to the surface preparation and surface roughness (Austin et al., 1999). The tests done by Austin and Robins showed that changing the surface from smooth condition to rough condition has a considerable influence on the result, but changing the roughness of the relatively rough surface by different methods does not change the results noticeably. Their results showed bond strength increases with the value two times bigger after changing the totally smooth surface into a rough surface, but changing the surface

roughness from relatively rough surface to high rough surface did not change the results markedly. Furthermore their studies showed that increase of the surface roughness can change the failure mode. So the failure surface changed from bond interface into the other planes.

In fact the existence of the compressive stress helps the interface to gain more friction and interlocks. So the influence of the compressive force on the interface is more than the influence of the surface preparation, unless when the surface is smooth. This means that the “slant shear test” method produces compressive force on the substrate and makes the bond stronger at the interface; so even for the unbonded surface, slant shear test may reports some strength.

The concept can be described precisely by using Coulomb theory (figure 4.10) and it can define the role of angle and compressive strength in the slant shear test results. The calculations show that the maximum load to achieve the failure is depending on the angle of the interface. Furthermore it proves that there is a critical angle for each surface roughness. Changes to the angle mean changing the compressive force which also means changing the friction.

$$\tau_n = c + \mu \sigma_n \quad (\text{Equation 4.1})$$

$$\tau_n = c + \tan \phi \cdot \sigma_n \quad (\text{Equation 4.2})$$

$$\sigma_{min} = 2c \cdot \tan [45 + \phi/2] \quad (\text{Equation 4.3})$$

Where τ and σ are shear and normal stresses, c is the adhesion strength; μ is the coefficient of friction and ϕ internal friction angle.

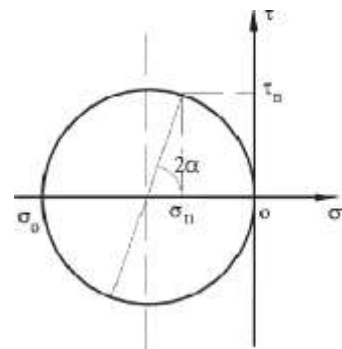

Figure 4.10. Slant shear test Mohr circle (Austin et al., 1999)

Austin and Robins represented the relationship between the angle and the σ/c ratio in which σ is the applied compressive stress and c is the strength in pure shear (Figure 4.11). This graph shows that the recommended 30° from BS 6319 is near to the minimum value for smooth surface. But as the surface becomes rough there is a need to have more stress to reach the failure in the same angle. The

rougher the surface the more stress needed, which matches with experiments results as well as calculations. Figure 4.11 shows for the medium rough surface if the angle changes to 25° the results of the slant shear test will decrease considerably. It can be added that a great increase of the angle, α , may cause a dramatic increase for the stress. Overall it can be understood that the rougher surface has lower critical angle, and this means less possibility of bond failure in standard 30° interface angle.

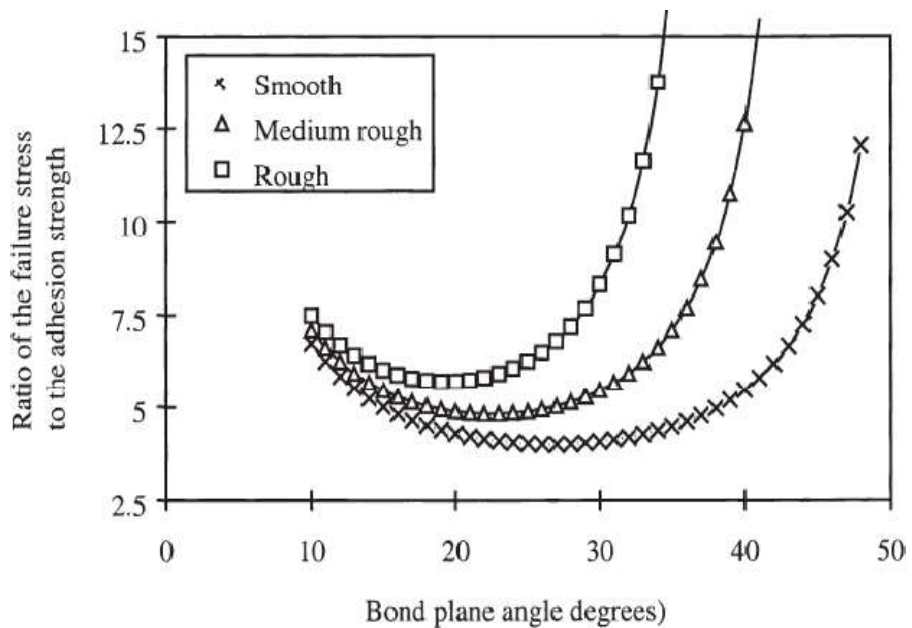

Figure 4.11. Influence of bond plane angle and roughness on failure stress (Austin et al., 1999)

Lastly, the test is so sensitive to differences between modulus of elasticity. The studies show that these differences between the stiffness of two materials cause the stress concentration and can affect the results. When the stiffness is different, the strain due to the same state of stress is different in the interface and it acts like a shear force in the interface. Finite element analyses also have shown that this modulus mismatch can produce eccentricity.

4.4 Shear tests

Different types of tests have been developed in which a shear force parallel to the interface is subjected to the interface. Figure 4.12 shows some of these shear tests. In other bonding test methods the subjected force is a compressive force, tensile force or torque. It is rather complicated to analyze the normal and shear stresses on the interface caused by forces in these tests, but in all these tests the failure occurs after development of shear cracks and not tensile ones.

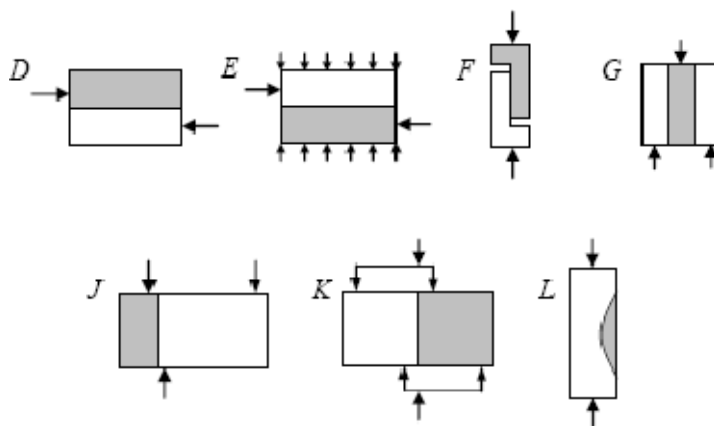

Figure 4.12. *Different Shear test for determination of bond strength (Silfwerbrand, 2003)*

Figure 4.12 D shows the common shear test (also known as mono surface shear test). The forces are applied parallel to the interface trying to meet the failure in the interface. In 1992 Pigeon and Saucier presented the “Modified Shear Bond

Method” in which the compression force subjected to the layers made the common shear test more appropriate with the situation in the site and this led to the achievement of larger values of bond in the test results (figure 4.12 E). The disadvantage of both tests is the moment produced by shear forces and their eccentricity from the interface. This moment can influence the test principle.

In order to solve the problem with undesirable effects of the moments the “Push-Out Specimen Method” was presented (Chen et al., 1995). As there were three forces involved in two directions with the proper geometry, the moments on the interface did not exist in this test, but this method could not represent the real condition since there are two interfaces in the test (Figure 4.12 G). This made the test impractical and complex to analyze.

The Guillotine Test Method solved the problem with moments as well as having only one interface (Figure 4.12 J). The third force is placed at a proper distance from the interface so the third force itself is not relatively large. Therefore the distance has more influence to neutralize the moment than the force does. This is mainly because if the third force was larger and the distance was shorter, the failure might occur in the substrate according to the shear forces. This test can be used both on cores and prisms.

The most important practical problem with all this category of tests is that all of them are laboratory tests and none of them can be used as an in-situ test method.

4.5 Torsion test

4.5.1 Twist-off test

Developed by Silfwerbrand, 2003, twist off test is a relatively new test method to appraise the bond strength in the interface. Although the failure in this test occurs because of development of tensile cracks but the stress which is applied to the specimen is a shear stress provided by torsion.

The importance of this test is the ability to perform it in the site. Except for the pull-off test which is basically a tensile test method, all other bonding tests have been developed for the laboratory. Therefore twist-off test is the only in-situ test method in which the interface is under shear stresses, it should be noted that the pull off test is also in-situ test method but the interface is exposed to direct tension.

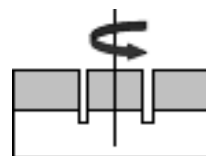

Figure 4.13. *Twist-off test*
(Silfwerbrand, 2003)

Indeed in many cases the real force that applies to the structure is not a torsion torque twisting the layers but since the torsion can cause pure shear in the surface (Figure 4.3 b), this test could be a good simulation to figure out the behavior of the interface under shear stress.

4.5.2 Test description

The procedure for pointing and marking the area, surface planning, attaching the disc to the core, partial coring is the same as in the pull-off test method. The only large difference is the type of load applied, which is torsion that needs special equipments (Silfwerbrand, 2003). A stand, a moment converter, some steel bars, a torsion gauge, rotational bearings, spherical bearings, a cylindrical plate are some of the equipments which are used to perform the test.

The bearings have quite an important role which is to prevent the development of any normal or shear force.

The relationship between shear stress and torsion moment can be calculated by following equations (Silfwerbrand, 2003):

$$\tau = \frac{T}{d^3} \times \frac{16}{\pi} \quad (\text{Linear elastic behavior}) \quad \text{Equation 4.4}$$

$$\tau = \frac{T}{d^3} \times \frac{12}{\pi} \quad (\text{Purely plastic behavior}) \quad \text{Equation 4.5}$$

Where, d is the core diameter, τ is the shear stress and T is the torsion. Although for concrete as a brittle material which is not fully elastic or purely plastic the relationship could be something between these two relationships, in order to limit the errors first relationship has been applied in the test.

The test has been done by Silfwerbrand using the core diameter of 100 mm and the load rate of 0.1 MPa/s. Some errors may occur due to the set ups, bearing operations, calibrations etc. The test still needs further development in equipments to be standardized. Also some numerical analysis would be desirable.

The original test developed by Silfwerbrand was presented as an in-situ test method, but it can also be done in the lab after coring the samples in the construction site.

4.5.3 Author's comment, "Slant Twist-off Test"

Based on theories from strength of material, when a torque is applied to a cylinder or beam it produces pure shear stress on the sections perpendicular to the center line of the cylinder or beam (Figure 4.14). The two dimensional stresses can be expressed in terms of principle stresses by Mohr circle. As it has been shown in figure 4.14 the elements with 45° from horizontal are exposed to principal stresses.

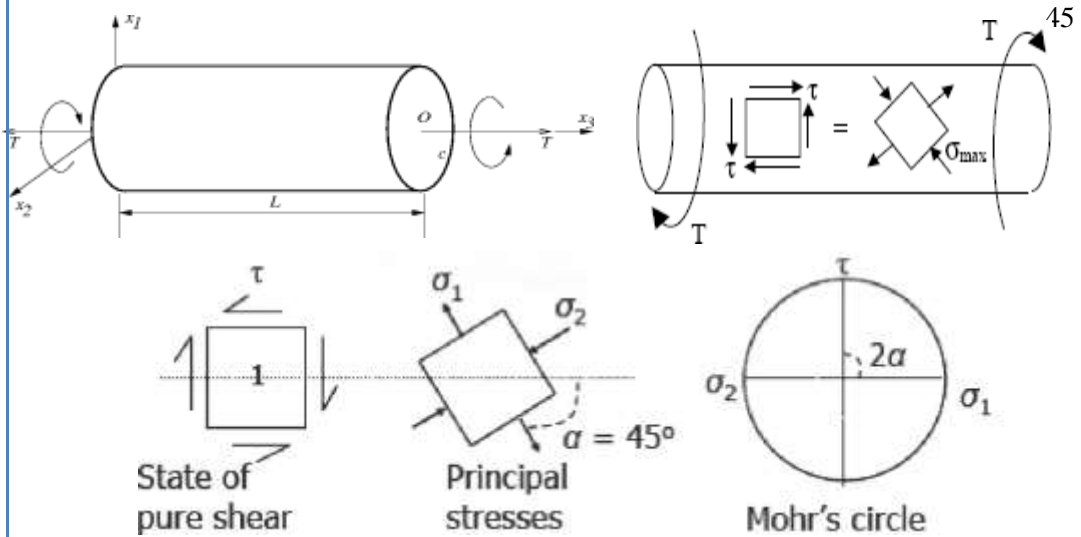

Figure 4.14. Torque produces pure shear on the sections perpendicular to the cross section

In a brittle material such as concrete the principle stresses in planes which have a 45° angle with the cross section generate inclined cracks. Initial cracks in longer and shorter sides connect and make the spiral cracks along the beam and with the same angle. Figure 4.15 shows the pattern of crack development.

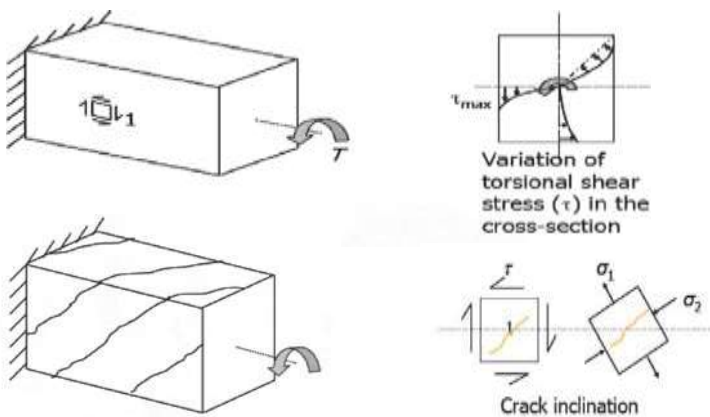

Figure 4.15. Pattern of crack development due to a torsion torque

For a homogenous brittle material subjected to the pure torsion the failure plane is not perpendicular to the beam axis, but it has an inclination around 45 degrees with the spiral shape (figure 4.16).

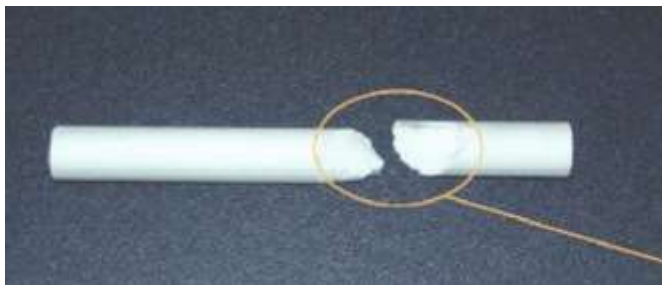

Figure 4.16. *Failure of brittle material due to a torque. Failure occurs in an inclined surface with spiral shape.*

Considering the failure envelop of the concrete (Figure 4.4) as a brittle material the expectation is to have failure in the inclined plane rather than the perpendicular plain. The same story exists in the twist-off test. The author believes that it would be better to place the interface in the same angle before testing. This means to have interface not perpendicular to the cross section but with a 45 degree direction from the axis (Figure 4.17).

It is important to note that the failure surface under pure torsion is a spiral shape (Figure 4.16) and not a simple inclined plane, but still a 45° inclined surface seems to be more fit with the real failure mode than the perpendicular surface.

Table 4.1 shows the results of the tests which have been done by Silfwerbrand, 2003. Among more than 50 cores only one of them has failed at the interface. This means that the geometry of test is not compatible with the applied force.

Table 4.1. *Test results for pull-off test and torsion test (Silfwerbrand, 2003)*

Reference	Pull off tests				Torsion tests			
	Number of cores	Average failure stress (MPa)	Number of interface failures	Average failure stress (MPa)	Number of cores	Average failure stress (MPa)	Number of interface failures	Average failure stress (MPa)
Cast-in-place concrete								
KTH Lab (waterjet)	15	1.98	1	2.23	9	3.97	0	—
KTH Lab (hammer)	16	1.10	5	0.96	9	3.42	0	—
KTH Lab (sandbl.)	8	2.38	3	1.73	5	4.51	1	3.93
Trollhättan (waterjet)	10	1.46	2	1.50	10	3.50	0	—
Shotcrete								
KTH Lab (waterjet)	16	1.72	0	—	16	3.35	0	—
Gnosjö (waterjet)	9	0.38	?	—	9	2.85	?	—

The advantages of having the slant interface plane are listed below:

- a) If the interface is placed in the proper direction, more samples will fail exactly in the bond surface, and there will be fewer failures in the other planes and fewer failures which are partly in the interface and partly inside the layers.
- b) If the interface is placed in the proper direction there will be less errors in the results
- c) In fact according to concepts, the concrete tends to fail in the inclined plane. Placing the interface with inclination make the situation proper for evaluating the bond surface. Having the slant interface, planes parallel to the interface both in the repair and the substrate, are subjected to the principle states of stresses. This makes the test more accurate for evaluation of the bond strength.
- d) Measuring the bond with inclined plane is concluded to give more reliable values as results. And also since the plane is under principal stresses, it would be easier to analyze the results and this means to avoid complexity. In the current test the top layer and substrate could support the interface to show larger bond strength than the real bond strength because the failure mode has been changed.

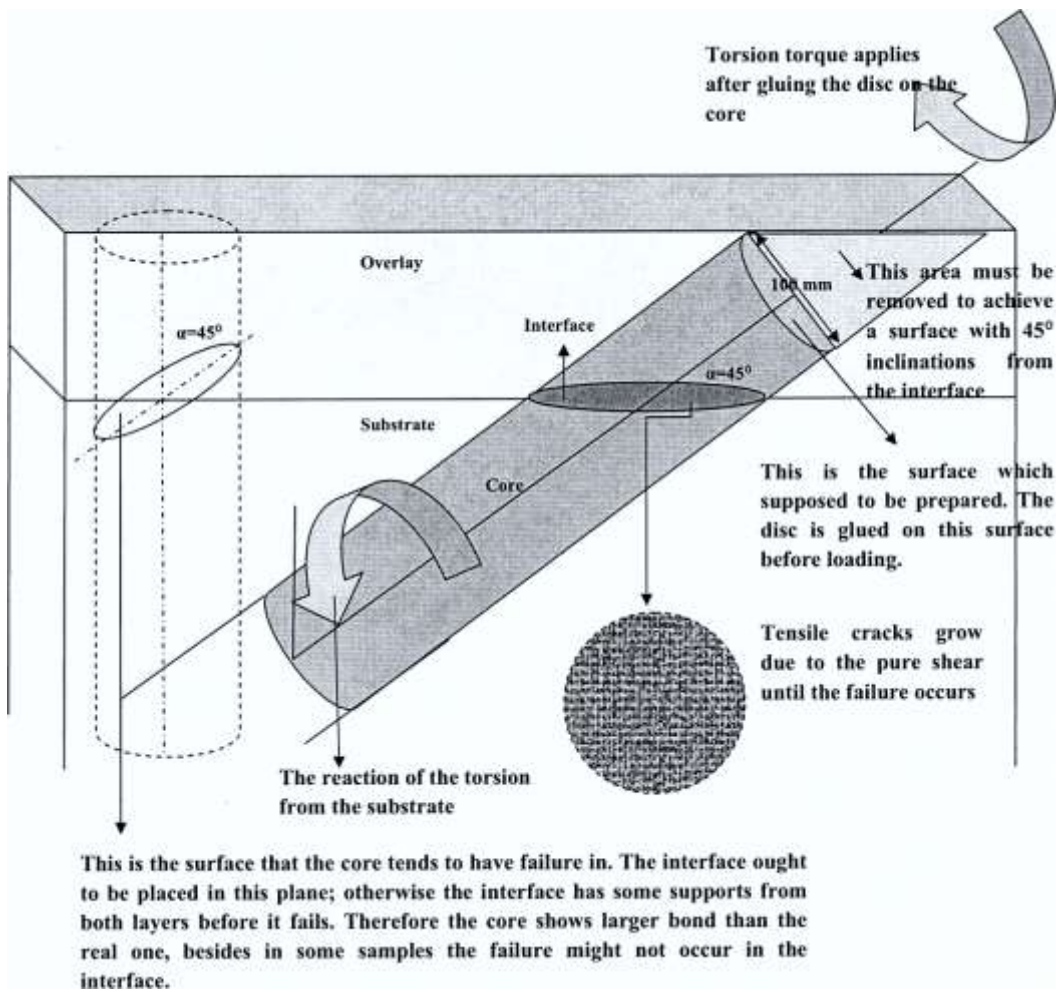

Figure 4.17. *The idea of Slant twist-off test*

In practice that would be easy to make the inclination in the lab by having the longer cores and cut them from the top and bottom with 45 degree (Figure 4.17). But since this test is mostly helpful as an in-situ test method, it is important to develop an inclined twist-off test at the construction site.

Figure 4.17 shows an easy way to make inclination in the site which is only an idea. Simple calculations show that it needs to dig out an isosceles right triangle with the area around 50 cm^2 in the overlay at first and then drill the core unevenly and then starting the test with the procedure mentioned before. (The preassumption of this calculation is to have cores with 10cm diameter, the same as test done by Silfwerbrand in 2003.)

4.6 Tests with indirect tension

Some references consider this category as a type of “Tensile Tests”. That is because the failure is due to the tension in both. In this thesis the classification has been done based on both failure mode and applied force. So since the force which is applied to the specimen is different in these tests, indirect test methods are discussed separately.

The concept of these tests is the same as the so called Brazilian test in rock mechanics (Figure 4.1 N and O). The Brazilian test is to compresses a sample diametrically inducing a stress that causes the sample to yield in tension. The test for homogeneous cylindrical specimens first was proposed by Japanese researchers, later some developments have been done in Brazil and finally the test standardized as ASTM C496.

In the Brazilian test the compressive force is subjected perpendicular by the disc and it causes tensile strains in the center of the disc with the same direction as the force. Cracks pass through upper and lower axes of loading and split the specimen into two halves. Therefore failure occurs after the development of tensile cracks (Figure 4.5 B).

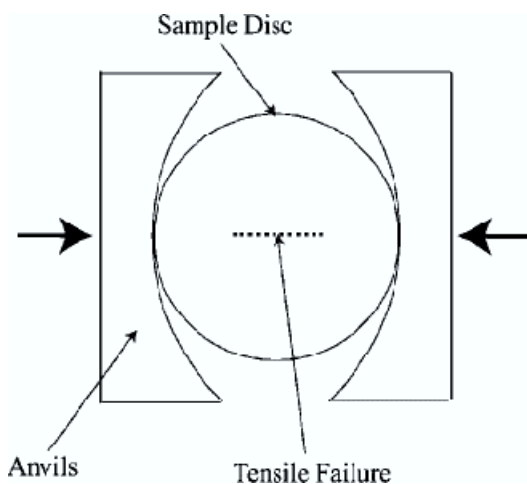

Figure 4.18. Typical Brazilian test fracture pattern (Grantham et al., 2004)



Figure 4.19. Brazilian test apparatus

One of the advantages of using this method compared to the normal tensile test is that the specimen geometry is very simple and the test is easy to prepare.

Figure 4.18 and figure 4.19 show typical Brazilian Test fracture pattern and the Brazilian test apparatus (Grantham et al., 2004). The instrument is useful for testing specimen from 50mm diameter to 100mm and of thickness equal to half the diameter. The specimen is held in circular jaws, this is primarily similar to a compression machine and consists of a small load frame having sturdy base with two vertical threaded rods and an adjustable cross head. The hydraulic jack is fitted at the centre of the base of the load frame (Momayez et al., 2004).

Figure 4.1 O shows a simple device called Prism Splitting Test device. Researchers in Alabama developed this test based on ASTM C496, in this test the cylinder is one-half repair material, and the interface is placed under the force and with the same direction (Li et al., 1999). The splitting tensile strength is calculated by the following equation:

$$\sigma = 2P / \pi A \quad (\text{equation 4-6})$$

Where σ =splitting tensile strength, MPa (psi); P =applied load (lbf); and A =area of bond plane, mm² (in.²) (Momayez et al., 2004).

Figure 4.1 N shows the Wedge Splitting Test device. This device is following the same theory and it measures the bond tensile strength according to parameters such as crack opening and specific fracture energy.

4.7 Comparison of test methods

4.7.1 Comparison between shear and tensile bond strength

Five different categories of test methods have been discussed. As it has been mentioned in this chapter two of these test are more popular in use. Table 4.2 summarizes all categories of tests discussed in this chapter, the force which is applied to the interface in each test, and the type of failure for each test. It should be noted that the concrete and so the bond interface has two different failure modes, either in tension or in shear (Figure 4.4). This means in some test that the tension produces the crack opening and in some other cases shear cracks cause the failure. The hybrid failure type shown in figure 4.4 is also considered as a type of shear failure.

Based on these two failure types Pull-off test and Slant Shear test are the most common test methods. One meets the tensile failure mode and the other meets the shear type of failure.

Table 4.2. *Classification of bonding tests based on subjected force and failure criteria*

Test Category	Common Method	Type of the force	Failure Mode
Tensile Test	Pull-Off	Tension	
Indirect Tensile Test	Splitting Prism	Compression	Tensile Failure
Torsion Test	Twist-Off Test	Torsion	
Shear Test	Mono-surface Shear	Shear	
Compressive Shear Test	Slant Shear	Compression	Shear Failure

Obviously for the same specimen the result from these two tests report different values as “Bond Strength”. Since the type of the force and the mechanism of the failure are totally different, logically the values of bond strength report from Slant Shear Test are larger because generally cement material are weaker in the tension. Despite the differences in results many investigations indicated that there is a correlation between the results of these two tests. This means that although it is always better to chose the test method based on the real situation of the construction site but both of them are practically applicable for a certain case.

Some studies by Silfwerbrand (2003) indicated that there is a mean ratio (Shear bond divided by tensile bond) around 2.4 between results of the two tests. Other investigations in Japan by Sato (1989) reported the ratio of 1.5. In order to explain this it should be noted that there are some factors that may have greater influence in one of these tests than the other one. Different researches and investigations might have different conditions such as surface preparations, curing, etc. but for the certain case there is always a correlation which can be helpful to convert the results and to find out the bond strength.

4.7.2 Experimental studies on comparison of methods results

In order to compare some real values of different test results and find out the type of correlation between different test results and also to study how results in particular tests change by changing some factors, an investigation has been done by Momayez, Ehsani and Ramezaniapour (2004) which is discussed here.

Their studies included four different bond test methods. Three of them are mentioned here; Pull-off test, slant shear and splitting prism test. They tested over 120 specimens. Substrate material and mix proportion have been the same for all specimens, but they used 6 different repair materials and two types of surface preparation for each repair material. Four of the repair materials have been cement mortar containing 0%, 5%, 7% or 10% of silica fume. One of them has been made by replacing 10% of cement content with a polymer adhesive named k100, and the last one has been made by replacing 20% of cement content with styrene butadiene resin, SBR. Low roughness means that the surface has been roughened by using steel wire brush with the amplitude around 3-4 mm and high roughness refers to the roughness around 7-8 mm.

Table 4.3. Test results for pull-off, splitting prism and slant shear test, (Momayez et al., 2004)

Specimen Group	Repair Material	Pull-off		Splitting prism		Slant shear			
		σ	N	σ	COV	N	σ	COV	N
RL	Reference 0% SF	1.18	2	1.19	7.3	4	8.12	15.8	4
RH		1.32	2	1.36	8.4	4	11.13	9.8	4
5L	5% SF	1.25	2	1.27	6.4	4	9.18	9.8	4
5H		1.38	2	1.44	7.2	4	11.9	8.4	4
7L	7% SF	1.37	2	1.38	10.4	4	10.32	9.4	3
7H		1.51	2	1.62	9.2	4	13.2	4.7	2
10L	10% SF	1.38	2	1.39	9.8	4	10.16	11.6	3
10H		1.53	2	1.64	11.2	4	13.02	7.3	2
KL	Modified by K100	1.82	2	1.95	10.6	4	11.59	10.8	3
KH		1.95	2	2.14	10.9	4	13.56	6.1	2
SL	Modified by SBR	2.38	2	2.69	9.7	4	12.19	12.2	2
SH		2.5	2	2.9	9.6	4	13.53	7.7	2
C	Continues	3.18	-	3.97	-	-	14.11	-	-
		2 Samples		4 Samples		4 Samples			

In order to achieve more reliable results, for each specific repair material there were two specimens in pull-off test, four specimens in splitting prism test and four specimens in slant shear test. The results were reported for each test method and each repair material with the COV (coefficient of variation) and mean

value (For the pull-off test only mean values were reported since there were just two specimens for each repair material).

Table 4.3 shows the result of specimens at the age of 28 days. σ is the mean value of bond strength in MPa and N is the number of samples failed in bond. Each group of specimens is identified with two characters. The first character or number refers to repair material and the second one is the surface preparation type which is either low roughness or high roughness. The continuous specimens has also been tested, however to allow comparison of the result of repaired specimens with a monolithic samples, an equivalent bond strength for these specimens was calculated by dividing the applied force by the corresponding non continuous bond area values, e.g., sloping area in the case of slant shear test.

From the results it can be understood that changing a factor i.e. the percentage of silica fume has greater effects in this slant shear test than the pull-off test. The average of increasement of the bond strength by adding 5%, 7% and 10% silica fume for both pull-off test and splitting test is around 9.5% but for the slant shear test is 16.3 % which is 1.7 times more (Figure 4.20). Results have been shown for the samples with low roughness. This means that two series of tests with different percentage of silica fume may have different correlation between shear and tensile test in each. Again it should be mentioned that many investigations has showed the correlation between shear and tensile test results but the correlation might differ depending on different conditions of the tests.

The bond strength recorded by slant shear is greater than the others; this is because of the influence of compressive force on the interface bond strength. Splitting prism strength and pull-off strength are close; the reason is that they follow the same failure mode in tension.

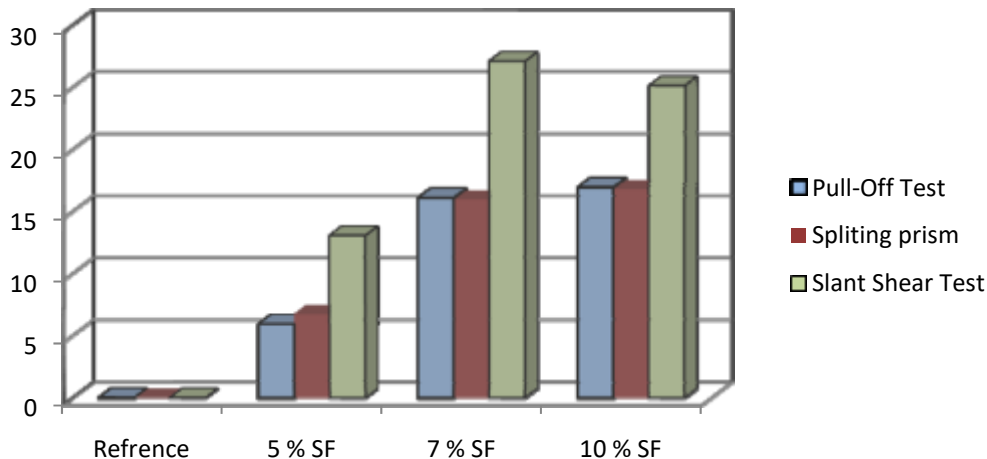

Figure 4.20. Percentage of incensement in bond strength by adding 5%.7% and 10% of silica fume. All samples surfaces are prepared with low roughness. The figure shows that adding silica fume has greater effect in the slant shear test results. . (Momayez et al., 2004)

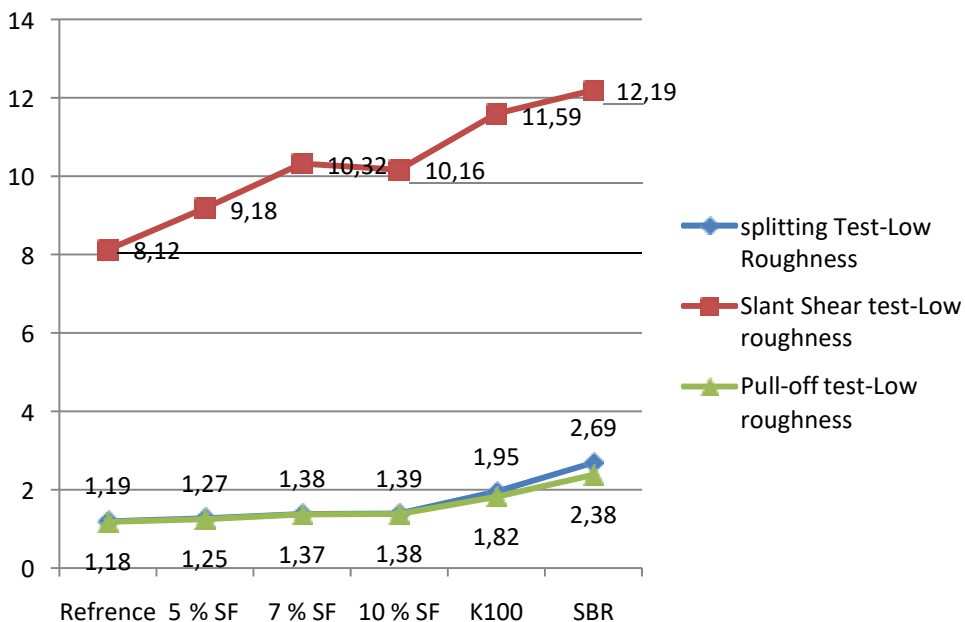

Figure 4.21. Test results for pull-off, splitting and slant shear test for low roughness samples. The two tensile tests have shown the same resistance but the result from slant shear is higher. (Momayez et al., 2004)

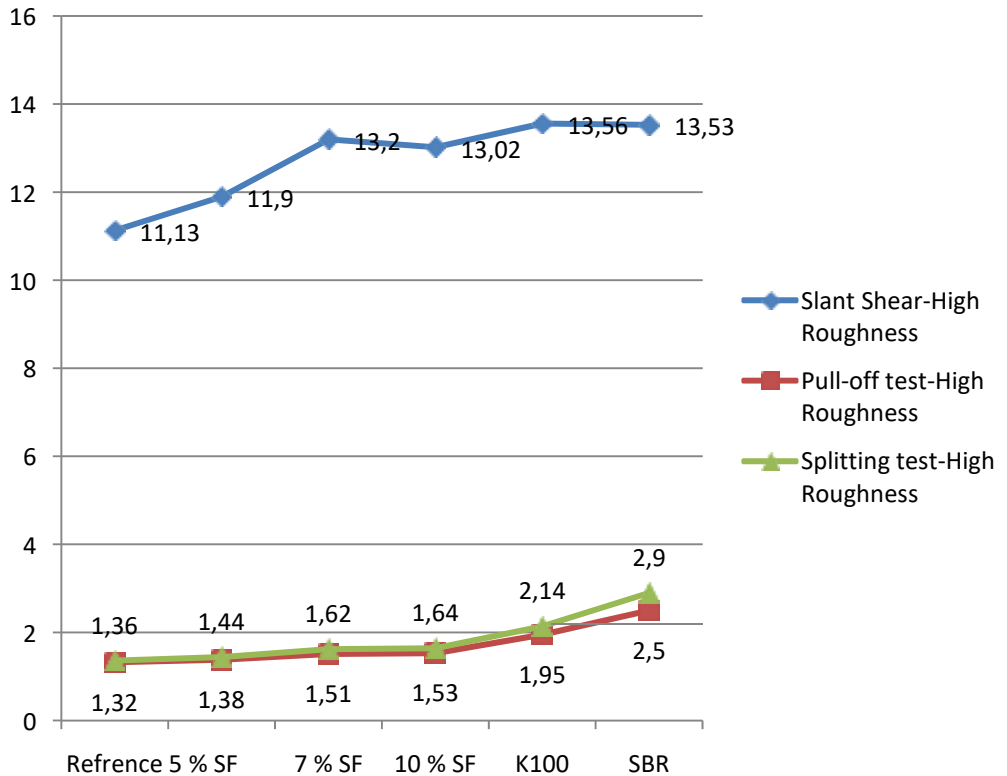

Figure 4.22. Test results for pull-off, splitting and slant shear test for high roughness samples. (Momayez et al., 2004)

As it was expected, there is a correlation between the result of slant shear test and pull off test. Here, in these series of tests the ratio for slant shear strength divided by pull-off strength is 6.8 for low roughness surfaces and 7.8 for high roughness surfaces.

Regardless of the test method, the continuous specimen showed higher strength than the one with two layers. Besides, results show that rougher surface and adding silica fume make the bond strength higher.

5. Summary and conclusions

Concrete repairing mainly includes removing unsound concrete and replacing it with repair or overlay materials. One of the key requirements for any kind of repair system is to have adequate bond strength between the existing concrete substrate and overlay throughout the service life.

There are different factors influencing the bond strength which are categorized into three levels based on their effects on bond strength; some of them are considered as major factors and some others are minor factors. Absence of micro cracks, absence of laitance, cleanliness of the interface, proper compaction and curing are the major factors influencing the bond strength.

5.1 Test methods discussion

The quality assurance of bond strength requires test methods that can quantify the bond strength as well as identify the failure mode. There have been numerous investigations led to development of different test methods. The forces which are applied in each test and the failure mode are important in order to choose the proper test. Tests are defined both in laboratory and field.

There is still a question that needs to be answered, what type of test is appropriate in general for the real projects? Back to the five categories of bonding tests, the shear tests and indirect tensile test have least popularity among the tests. They all need to be done in the lab and there are also other disadvantages with them as it has been discussed before. The twist-off test seems to be a proper test; it is an in-situ test method and shear force is applied, but the test is relatively new and still needs to have more development and analytical studies. Slant shear test and pull off test are quite popular. Indeed the pull-off test is the most popular and world widely accepted one. Since the test is simple, easy to set up, and in-situ test. Besides, time and financial issues are also important in a project, which is one of the main reasons of spread usage of pull-off test, because it can be performed and led to the result in a short time. In addition, since concrete materials always show weakness in tension, a tensile test is in priority.

In cases when there is a possibility to choose between these two, the author's idea is to use the test which is more proper to the situation of the construction site. For example in the repair of pavement or bridge deck there is

always a compressive force combined with shear, and there is less tension. But for some cases the tension is higher. Of course in the situation that both tension and compression exist the weakness is from the tensile side.

5.2 Other test developments for bond determination

In some cases destructive tests are not proper. Consequently, there are some ways for instance chain dragging or trapping the surface with hammer that can be used to determine the locations of debonding. Later developments may focus more on microscope scanning or ultrasonic tests, and other types of nondestructive test to observe the cracks and voids at the interface.

BIBLIOGRAPHY

- American Society for Testing and Materials. (1999). *Standard Test Method for Bond Strength of Epoxy-Resin System Used with Concrete by Slant Shear*, ASTM C 882-99. Philadelphia, PA: ASTM International Standards.
- American Society for Testing and Materials. (2004). *Standard Test Method for Splitting Tensile Strength of Cylindrical Concrete Specimens*, ASTM C 496/C 496M. Philadelphia, PA: ASTM International Standards.
- American Society for Testing and Materials. (2004). *Standard Test Method for Tensile Strength of Concrete Surfaces and the Bond Strength or Tensile Strength of Concrete Repair and Overlay Materials by Direct Tension (Pull-off Method)*, ASTM C1583/C1583M. Philadelphia, PA: ASTM International Standards.
- Atzeni, C., Massidda, L., and Sanna, U. (1993). Dimensional Variations, Capillary Absorption and Freeze-Thaw Resistance of Repair Mortars Admixed with Polymers. *Cement and Concrete Research*, 23, 301-308.
- Austin, S., Robins, P., and Pan, Y. (1995). Tensile Bond Testing of Concrete Repairs. *Material and Structures*, 28, 249-259.
- Austin, S., Robins, P., and Pan, Y. (1999). Shear Bond Testing of Concrete Repairs. *Cement and Concrete Research*, 29, 1067-1076.
- Beaupre, D. (1999). Bond Strength of Shotcrete Repair. *Shotcrete Magazine*, 1, (2), 12-15.
- Bonaldo, E., Barros, J.A.O and Lourenco, P.B. (2005). Bond Characterization between Concrete Substrate and Repairing SFRC Using Pull-Off Testing. *International Journal of Adhesion and Adhesives*, 25, 463-474.
- British Standards. (1984). *Slant Shear Test Method for Evaluating Bond Strength of Epoxy Systems*, BS 6319, Part 4. London: British Standard Institution BSI.
- Bungey, J. H., and Mandandoust, R. (1992). Influencing Pull-off Tests in Concrete. *Magazine of Concrete Research*, 44, (158), 21-30.

- Cement Concrete and Aggregates Australia. (2006). *Compaction of Concrete*. Sydney: CCAA.
- Cement Concrete and Aggregates Australia. (2006). *Curing of Concrete*. Sydney: CCAA.
- Chen, P., Fu, X., and Chung, D.D.L. (1995). Improving the Bonding between Old and New Concrete by Adding Carbon Fibers to the New Concrete. *Cement and Concrete Research*, 25, (3), 491-496.
- Courard, L., Bissonnette, B. and Blair, N. (2006). Effect of surface preparation techniques on the cohesion of superficial concrete: comparison between jack-hammering and water-jetting. In *Concrete Repair, Rehabilitation and Retrofitting* (pp. 1027-1031). London: Taylor & Francis Group.
- Delatte, N.J., Williamson, M.S., and Fowler, D.W. (2000a). Bond Strength Development of High-Early-Strength Bonded Concrete Overlays. *ACI Materials Journal*, 97-M27, 201-207.
- Delatte, N.J., Wade, D.M., and Fowler, D.W. (2000b). Laboratory and Field Testing of Concrete Bond Development for Expedited Bonded Concrete Overlays. *ACI Materials Journal*, 97-M33, 272-280.
- Fu, G. (2005). *Inspection and monitoring techniques for bridges and civil structures*. Cambridge, UK: Cambridge Woodhead.
- Glenn, W. S. (2002). *Guide to Concrete Repair*. New York, NY: United States Department of Interior, Bureau of Reclamation.
- Grantham, S. G., Siviour, C. R., Proud, W. G., and Field, J. E. (2004). High-Strain Rate Brazilian Testing of an Explosive Simulant Using Speckle Metrology. *Measurement Science and Technology*, 15, 1867-1870.
- Julio, E.N.B.S., Branco, F.A.B. Silva, V.D. (2004). Concrete-to-concrete Bond Strength, Influence of the Roughness of the Substrate Surface. *Construction and Building Materials*, 18, 675-681.
- Kosmatka, S. H., Kerkhoff, B. and Panarese, W. C. (2002). *Design and Control of Concrete Mixtures* (14th ed.). Skokie, IL: PCA Engineering Bulletin EB 001.

- Kreigh, J. D. (1976). Arizona Slant Shear Test: A Method to Determine Epoxy Bond Strength. *ACI Journal*, 73, (7), 372-373.
- Li, S.E., Geissert, D.G., Frantz, G.C., and Stephens, J.E. (1999). Freeze-Thaw Bond Durability of Rapid-Setting Concrete Repair Materials. *ACI Materials Journal*, 96-M31, 241-249.
- Long, A.E., and Murray, A. (1984). The Pull-off Partially Destructive Test for Concrete. *ACI Materials Journal*, ACI SP-82, 327-350.
- Mathey, R. G., and Knab, L. I. (1991). Uniaxial Tensile Tested to Measure the Bond of In-situ Concrete Overlays. *NISTIR 4648*.
- Momayez, A., Ehsani, M.R., Ramezani-pour, A.A. and Rajaie, H. (2005). Comparison of Methods for Evaluating Bond Strength between Concrete Substrate and Repair Materials. *Cement and Concrete Research*, 35, 748-757.
- Perkins, P. H. (1997). *Repair, Protection and Waterproofing of Concrete Structures*. London, UK: Spon E & F N.
- Pigeon, M., and Saucier, F. (1992). Durability of Repaired Concrete Structures. In *Proceedings, International Symposium on Advances in Concrete Technology* (pp. 741-773), Athens.
- Ramsey, J. M., and Chester, F. M. (2004). Hybrid fracture and the transition from extension fracture to shear fracture. *Nature international journal of science*, 428, 63-66.
- Sato, R. (1998). Recent Technology of Concrete Pavement in Japan. In *Proceedings, 4th CANMET/ ACI/ JCI International Symposium on Advances in Concrete Technology*, Tokushima, Japan, 1998.6, 71-85.
- Silfwerbrand, J. (1990). Improving Concrete Bond in Repaired Bridge Decks. *Concrete International*, 12, (9), 61-66.
- Silfwerbrand, J., and Paulsson, J. (1998). The Swedish Experience: Better Bonding of Bridge Deck Overlays. *Concrete International*, 20, (10), 56-61.

Silfwerbrand, J. (2003). Shear Bond Strength in Repaired Concrete Structures.

Materials & Structures, 36, 419-424.

Stehno, G., and Mall, G. (1977). The Tear-off Method, A New Way to Determine the Quality of Concrete in Structures on site. *RILEM International, Symposium on Testing In Situ of Concrete Structures* (pp. 335-347), Budapest.

Talbot, C., Pigeon, M., Beaupre, and Morgan, D.R. (1994). Influence of Surface Preparation on Long-Term Bonding of Shotcrete. *ACI Materials Journal*, 91-M56, (6), 560-566.

U.S. Army Corps of Engineers. (1993). *Standard Practice for Shotcrete*. Engineering Manual EM 1110-2-2005. Washington, DC: U.S. Army Corps of Engineers.

U.S. Army Corps of Engineers. (1999). *An Evaluation of Equipment and Procedures for Tensile Bond Testing of Concrete Repairs*. Technical Report REMR-CS-61. Washington, DC: U.S. Army Corps of Engineers.

Wall, J. S. , and Shrive, N. G. (1988). Factors Effecting Bond between New and Old Concrete. *ACI Materials Journal*, 85, (2), 117-25.