

A Realistic Technology and Engineering Assessment of Algae Biofuel Production

T.J. Lundquist^{1,2}, I.C. Woertz¹, N.W.T. Quinn², and J.R. Benemann³

¹ Civil and Environmental Engineering Department
California Polytechnic State University
San Luis Obispo, California

² Earth Sciences Division
Lawrence Berkeley National Laboratory
Berkeley, California

³ Benemann Associates
Walnut Creek, California

Energy Biosciences Institute
University of California
Berkeley, California

October 2010

EXECUTIVE SUMMARY

This report assesses the economics of microalgae biofuels production through an analysis of five production scenarios. These scenarios, or cases, are based on technologies that currently exist or are expected to become available in the near-term, including raceway ponds for microalgae cultivation, bioflocculation for algae harvesting, and hexane for extraction of algae oil. Process flow diagrams, facility site layouts, and estimates for the capital and operations costs of each case were developed *de novo*. This report also reviews current and developing microalgae biofuel technologies for both oil and biogas production, provides an initial assessment of the US and California resource potential for microalgae biofuels, and recommends specific R&D efforts to advance the feasibility of large-scale algae biofuel production.

Contents of the Report

Chapter 1 introduces microalgae biofuels production. Chapter 2 reviews the biology and biotechnology of microalgae, including major taxa, cell composition, resource requirements, productivities, and possible algae strain improvement through genetic methods.

Chapter 3 addresses the engineering of microalgae production systems, emphasizing those for commercial production of nutritional supplements, which are the main current application of microalgae cultivation. Also discussed are past and current efforts to advance microalgae biofuels research to larger scales, as well as the existing large-scale use of microalgae in wastewater treatment. Wastewater is an attractive resource for algae production due to its nutrient content and low cost. Closed photobioreactors are reviewed briefly. Although they are unsuitable for large-scale biomass production, they have applications for producing starter cultures (inocula). Similarly, heterotrophic algae production is not considered extensively due to the high cost of the needed reactors and feedstocks.

Chapter 4 addresses the potential resource base for microalgae biofuels production in the US, with California analyzed in more detail. The availability of the resources required for microalgae production—land, climate, water, and, perhaps most critically, carbon dioxide—at the same site, will likely limit the US potential for algae oil production to less than a few billion gallons annually. While minor compared to total US transportation fuels consumption (about 200 billion gallons per year), renewable algae oil could be a major contributor to biofuel resources, particularly in specific markets, such as aviation fuel.

Chapter 5, the major chapter of this report, details five microalgae biofuel production scenarios, or cases, for a hypothetical location in the Imperial Valley in southern California, a

promising region for algae production. In all five cases, water and nutrients (N and P) are supplied by municipal wastewater, which also provides some of the carbon needed for algae growth. Additional CO₂ is supplied by flue gas from a natural gas-fired power plant.

The cases differ in three main ways: (1) primary process objective—either biofuel production or wastewater treatment, (2) biofuel outputs—either biogas only or biogas plus oil, and (3) farm size—growth ponds covering either 100 or 400 hectares (250 or 1,000 acres).

Sale of algae co-products, such as pigments or animal feeds, could improve the economics of algae biofuel, but it is not considered in this analysis because the higher value co-product markets would likely become saturated before significant biofuel quantities were produced, while commodity animal feed co-production would likely not have a decisive effect on biofuels production costs without other production improvements in addition.

Unlike most prior techno-economic reports on microalgae biofuel systems, discussed below, this study fully incorporates wastewater treatment in process design and economics. In addition, the design details and cost updates in this study were developed independently, with many distinct design features, and thus is not directly comparable to prior studies.

Technology Assumptions

The technologies used in the facility designs were selected to meet three feasibility criteria: scalability, low parasitic energy demand, and low cost. The cultivation systems are open, raceway, paddle wheel-mixed ponds (“high rate ponds”), a technology already used in commercial microalgae production plants and some pilot-scale biofuels projects. The pond designs of this report differ from existing commercial designs in having larger individual ponds and in mostly being lined with compacted clay instead of plastic. The biomass harvesting is by bioflocculation (natural flocculation of the algae) followed by sedimentation. This process is based on experience with small-scale algae systems and is analogous to conventional (non-algal) wastewater treatment processes. Thickening of the resulting algae slurry is by gravity sedimentation, and, for the oil producing cases, biomass drying is done primarily with solar heat. For the methane-only production cases, no drying is required.

The algae farm designs are based on methods and standards of agricultural engineering rather than on more costly civil engineering and municipal standards. For example, the clarifiers and anaerobic digesters use plastic-lined earthen basin designs rather than concrete tank designs.

For recovery of the algae oil (triacylglycerides) from the dried biomass, a hexane extraction process similar to that used for soybean oil extraction was selected. Such extraction plants must be large (~4,000 metric tons/day) for economies of scale, which requires a centralized processing plant and two-way hauling of raw and extracted biomass from a multitude of algae

farms (e.g., fifty 400-ha farms for a 4,000 mt/d extraction plant). Despite this limitation, solvent extraction is the most economical method currently available. Other approaches may be developed in the future (e.g., cell breakage followed by oil emulsification and centrifugation).

The major technical assumptions for all five cases are 25% recoverable triacylglyceride content in algae biomass and 22 g/m²-day (80 mt/ha-yr) annual average total biomass productivity, of which 20 g/m²-day is harvested. The resulting oil yield is about 20,000 liters/ha-yr (2,100 gal/acre-yr). The individual ponds are 4 hectares (10 acres) in size (690 m by 60 m, with 30-m wide channels) and mixed with paddle wheels at a nominal water velocity of 25 cm/sec. The hydraulic residence time in the ponds is 3 to 5 days, depending on season. Flue gas CO₂ is supplied by countercurrent sumps within the ponds to eliminate any carbon limitation on the algae growth rate.

To provide the starter cultures of selected or improved microalgae strains assumed to be developed for this process, an algae inoculum production system is provided. It uses a small area of photobioreactors (not a significant cost), followed by small covered, plastic-lined ponds, and finally 4-ha plastic-lined ponds.

For the oil-producing cases, after oil is extracted from the dried algae biomass, the residual biomass is returned to the pond facility, re-wetted, and anaerobically digested. The biogas produced is used for electricity generation with the flue gas providing CO₂ to the ponds. The digester residuals, with their carbon and nutrients, are recycled, as needed, to the algae production ponds. For the cases that produce only biogas, the algae biomass is not dried or extracted, only digested.

As examples of the processes analyzed, Figure ES1 shows the process schematic for the case having wastewater treatment as the main objective, with biogas as the byproduct. Figure ES2 shows the case with oil production as the main objective, with treated wastewater as the byproduct. The major differences in Figure ES2 compare to Figure ES1 are the large proportion of water recirculated and the use of solvent extraction. The cases with the primary objective of biofuel production do not produce more oil or biogas per hectare than the cases emphasizing wastewater treatment, but rather, they are meant for larger scales in which wastewater is used only for make-up of lost water and nutrients.

The microalgae cultivation and harvesting facilities for the five cases are designed with enough detail to allow a preliminary level of cost estimation (i.e., with process designs, sizing of unit operations, mass balances, and selection of the construction materials and methods). The construction, operation, and land costs are specific to the Imperial Valley or nearby areas of southern California.

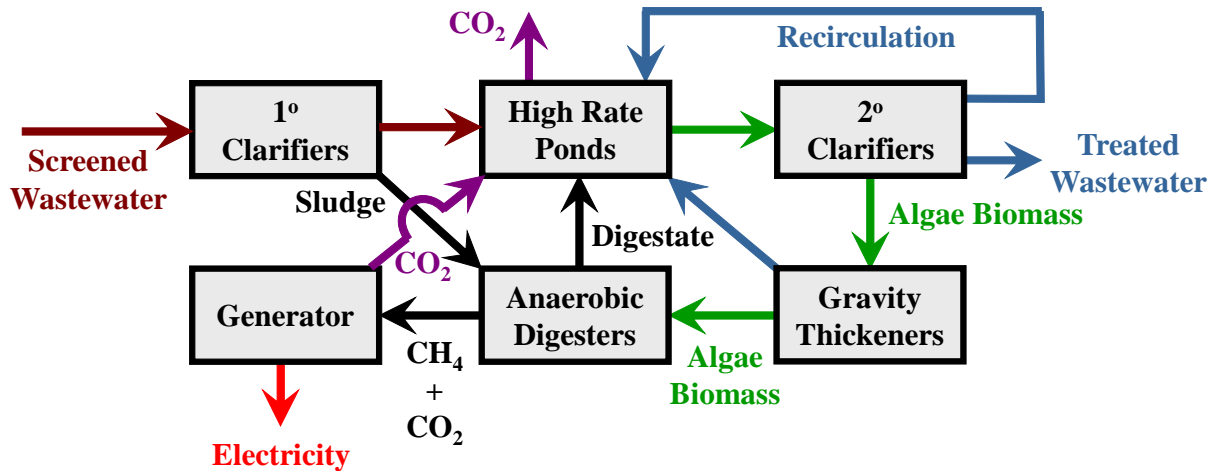

Figure ES1: Process schematic for Case 2 (wastewater treatment-emphasis with production of biogas only). The cases with a wastewater treatment-emphasis discharge large quantities of treated wastewater as the main facility product. (1° = Primary; 2° = Secondary.)

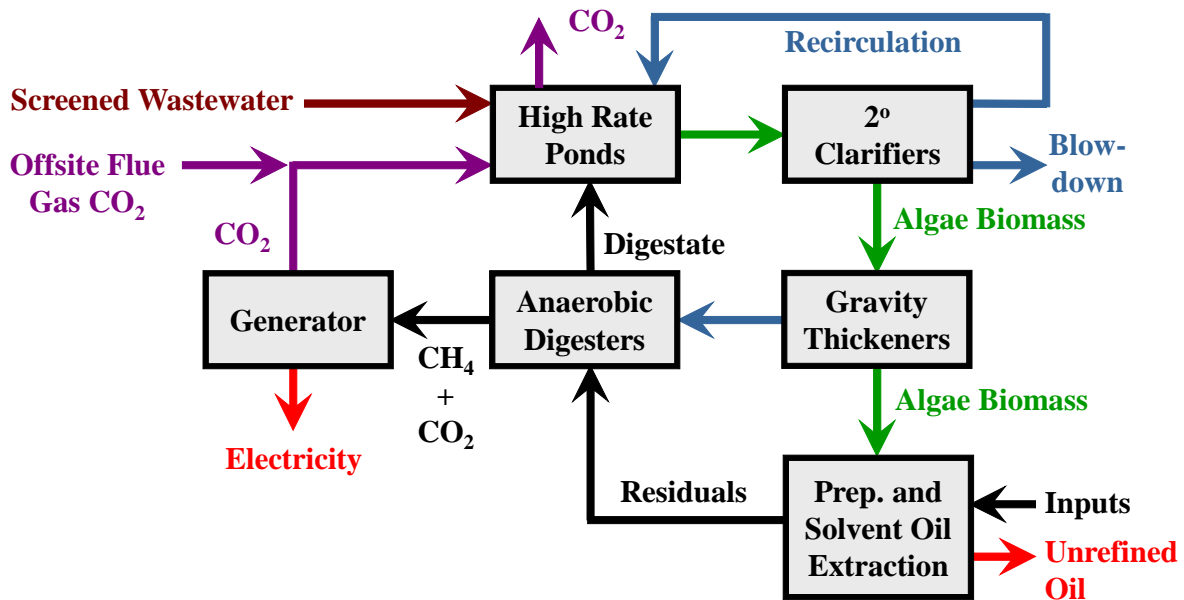

Figure ES2: Process schematic for Cases 3 and 5 (biofuel-emphasis with both oil and biogas produced). The cases with a biofuel-emphasis discharge a relatively small amount of water as blowdown, with most of the microalgae growth medium being recycled. A shared, centralized biomass preparation (cell disruption) and solvent extraction plant is included.

Total costs are based on an 8% total annual capital charge (interest and depreciation) and a 30-year pay-off (see Endnote for explanation). The resulting cost metric is the cost of production per unit of oil or electrical power produced, including any wastewater treatment credits. The processing of the crude algae oil (e.g., to biodiesel or green diesel) is not included in this analysis.

Results for the Five Cases

The five cases examined (Table ES1) differ in the following ways:

1. The primary process objective is either wastewater treatment with biofuels as byproducts (Cases 1-2) or biofuel production with treated wastewater as the byproduct and wastewater providing make-up water and nutrients (Cases 3-5).
2. The biofuels produced are either oil plus biogas (Cases 1, 3, 5) or biogas only (Cases 2 and 4).
3. The total pond area of each farm is either 100 ha (Cases 1-4) or 400 ha (Case 5).
4. The biofuels-emphasis cases are not operated year-round due to low winter algae productivity, which results in poor economics and negative energy balances.
5. As a result of the above differences, the cases have different rates of biomass and biofuel production (Table ES1).

Table ES1: Characteristics of the algae biofuel production cases

Case	Emphasis	Wastewater Influent (ML/yr) ^A	High Rate Pond Area (ha)	Operation Schedule ^B (mo/yr)	Biomass Harvest (mt/yr)	Biogas CH ₄ Production ^C (10 ⁶ m ³ /yr)	Oil Production (bbl/yr)
1	Treatment	22,740	100	12	7,440	2.56	12,770
2	Treatment	22,740	100	12	7,440	3	None
3	Biofuel	3,160	100	10	7,200	1.73	12,300
4	Biofuel	2,820	100	8	6,760	2.03	None
5	Biofuel	13,600	400	10	28,900	6.95	49,300

- A. The algae farms with a biofuel production emphasis take in only enough wastewater to make-up for losses of water and nutrients. ML/yr is megaliters per year; 22,740 ML/yr= 16.5 million gallons/ day.
- B. For the biofuels-emphasis cases, operation is not justified during the winter due to low algae productivity, which leads to a low operating margin and/or a negative energy balance.
- C. Cases 1 and 2 have high methane (CH₄) production due to digestion of primary wastewater sludge. Cases 3 and 4 have similar CH₄ production, despite the extraction of oil prior to digestion in Case 3, due to differing operation schedules.

Cases 1 and 2 each involve remediation of the wastewater from a population center of 165,000-235,000 persons using a 100-ha algae farm. The water undergoes primary clarification (i.e., settling) on-site before entering the algae ponds. Harvested algae biomass either undergoes oil extraction with the residual biomass being anaerobically digested (Case 1), or, alternatively, the entire biomass is digested with only biogas produced (Case 2). For Case 1, the harvested biomass is dried and trucked to a central oil extraction facility, which is shared by five 100-ha farms. In Cases 1 and 2, the farms receive a sizable income for their wastewater treatment function.

In Cases 3-5, wastewater is used mainly to replace evaporative water and nutrient losses, and water is extensively recycled within the systems. These cases import smaller flows of wastewater (from 20,000-30,000 persons per 100 ha), and therefore the influent is not subjected to primary clarification, saving some capital costs but slightly decreasing methane outputs. The digester effluents are recycled to the ponds to recapture their carbon and nutrient content. Case 5 is similar to the oil-producing Case 3, except at larger scale, with individual farms covering 400 ha. Case 4 is a primarily a biogas production facility. The much lower wastewater flows used in Cases 3-5 result in a much lower income for wastewater treatment compared to Cases 1 and 2. This income is a major factor in the overall economics.

Results of Cost Analyses

Tables ES2 and ES3 show the capital and operating cost estimates for the algae biofuel facilities. The land and the high rate pond construction are the most costly capital items, and staffing is the highest cost in operations for all cases. Maintenance, assumed to be 2% of capital cost, is generally the next highest annual operating expense. Within the 100-ha size class, production of oil (Cases 1 and 3) added considerable expense compared to production of biogas only (Cases 2 and 4). Capital costs are 30-40% higher and operating costs approach 100% higher due to the additional facilities needed for the oil producing cases. The 400-ha Case 5 has only a 3.3-fold higher capital cost than the analogous 100-ha Case 3, indicating the economy of scale. Similarly, the Case 5 operating costs are only 2.9-times greater than those of Case 3.

Table ES4 summarizes the overall costs and revenues and provides the overall production cost for oil or electricity. Storage of algae oil and its refining to fuel (e.g., esterification of fatty acids to biodiesel) are outside the scenario boundaries.

Table ES2: Capital costs of the algae biofuel production cases

Case:	Case 1	Case 2	Case 3	Case 4	Case 5
Pond Area:	100 ha	100 ha	100 ha	100 ha	400 ha
Emphasis:	Treatment	Treatment	Biofuel	Biofuel	Biofuel
Biofuel:	Oil & Gas	Gas	Oil & Gas	Gas	Oil & Gas
Land ^A	\$4,710,000	\$4,120,000	\$2,350,000	\$2,060,000	\$9,410,000
High rate ponds	\$3,410,000	\$3,410,000	\$3,410,000	\$3,410,000	\$13,600,000
Digesters	\$2,440,000	\$2,190,000	\$2,150,000	\$1,900,000	\$8,620,000
Extraction plant ^B	\$2,430,000	None	\$2,430,000	None	\$665,000
Drying beds	\$2,420,000	None	\$2,420,000	None	\$9,690,000
Biogas turbine	\$2,040,000	\$2,440,000	\$1,620,000	\$2,010,000	\$6,480,000
Electrical	\$1,900,000	\$1,900,000	\$1,900,000	\$1,900,000	\$7,600,000
Water piping	\$1,660,000	\$1,400,000	\$1,590,000	\$1,320,000	\$6,370,000
Final dryer	\$1,020,000	None	\$1,020,000	None	\$2,070,000
2 ^o Clarifiers	\$948,000	\$957,000	\$936,000	\$936,000	\$3,750,000
CO ₂ delivery	\$594,000	\$594,000	\$594,000	\$594,000	\$2,380,000
1 ^o Clarifiers ^C	\$420,000	\$420,000	None	None	None
Roads & fences	\$338,000	\$241,000	\$338,000	\$241,000	\$1,350,000
Thickeners	\$256,000	\$256,000	\$255,000	\$255,000	\$1,020,000
Buildings	\$120,000	\$120,000	\$120,000	\$120,000	\$480,000
Silo storage	\$109,000	None	\$109,000	None	\$470,000
Vehicles	\$100,000	\$100,000	\$100,000	\$100,000	\$400,000
Sub-total	\$24,915,000	\$18,148,000	\$21,342,000	\$14,846,000	\$74,355,000
Total with Cost Factors^D	\$35,722,000	\$26,044,000	\$30,606,000	\$21,320,000	\$101,585,000

- A. The cases emphasizing treatment have higher land costs due their assumed location near larger cities.
- B. A centralized oil extraction plant is shared by multiple algae farms. The cost shown is the share of the extraction plant cost allocated to a single farm.
- C. For the cases with a wastewater treatment emphasis, screened wastewater is treated in on-site primary clarifiers to improve treatment. For the cases with a biofuel production emphasis, the relatively small flow of screened wastewater is delivered directly to the high rate ponds.
- D. Cost factors are included for permitting, mobilization, construction insurance and management, engineering, legal, and contingency. Details are provided in Chapter 5.

Table ES3: Annual operating costs of the algae biofuel production cases

Case:	Case 1	Case 2	Case 3	Case 4	Case 5
Pond Area:	100 ha	100 ha	100 ha	100 ha	400 ha
Emphasis:	Treatment	Treatment	Biofuel	Biofuel	Biofuel
Biofuel Product:	Oil & Gas	Gas	Oil & Gas	Gas	Oil & Gas
Algae facility staff	\$748,000	\$587,000	\$694,000	\$534,000	\$2,780,000
Maintenance (2% cap.)	\$498,000	\$363,000	\$427,000	\$297,000	\$1,490,000
Extraction plant	\$478,000	None	\$478,000	None	\$232,000
Electricity purchase ^A	\$358,000	None	\$333,000	None	\$1,360,000
Administrative staff	\$375,000	\$375,000	\$375,000	\$375,000	\$375,000
Biomass hauling ^B	\$239,000	None	\$239,000	None	\$929,000
Insurance	\$180,000	\$180,000	\$180,000	\$180,000	\$720,000
Outside lab testing	\$50,000	\$50,000	\$50,000	\$50,000	\$50,000
Vehicle maintenance	\$15,000	\$15,000	\$15,000	\$15,000	\$60,000
Lab & office supplies	\$12,500	\$12,500	\$12,500	\$12,500	\$50,000
Employee training	\$10,000	\$10,000	\$10,000	\$10,000	\$40,000
Total	\$2,960,000	\$1,590,000	\$2,810,000	\$1,470,000	\$8,090,000

- A. All cases produce more electricity than they consume annually. However, for accounting purposes in Cases 1, 3, and 5, the gross electricity consumed is treated as if it were purchased from the power utility at \$0.10/kWh (as seen in this table), while the gross electricity produced is treated as if it were sold to the utility at \$0.10/kWh (as seen in Table ES4). For Cases 2 and 4, only net electricity production is considered as it is the product for which a cost of production is to be determined.
- B. For the oil-producing cases, biomass must be hauled to and from the extraction plant.

Cases 1 and 2, with biofuels production as a byproduct of wastewater treatment, are highly favorable economically in this analysis. Case 1 results in a cost of production that is about a third of current petroleum oil prices. Case 2 (biogas only) achieves positive net revenue without any income from the sale of biogas-derived electricity, meaning that the wastewater treatment revenues more than cover the capital and operating costs of the facility. However, these results are highly sensitive to changes in either costs or revenues, because total costs nearly equal total revenues for both Cases 1 and 2.

The economics are not favorable for Cases 3 and 4, where wastewaters are only supplementary to biofuel production and, thus, wastewater treatment credits are much smaller (less than 15% of Cases 1 and 2). However, even these small amounts of credit reduce oil or electricity costs by about 20%.

To achieve break-even for Cases 3 and 4, oil would need to be sold for \$332/barrel and electricity for \$0.72/kWh, respectively, both far higher than current prices. Although renewable energy and greenhouse gas abatement credits may be available for such a process,

these are speculative at this time and, in any event, would not be sufficient under any plausible scenario to make such a process economic. For Case 5, which is similar to Case 3 but four-times larger (400 ha), economies of scale reduce the cost of production by a quarter, to \$240/barrel, still much too high for current or foreseeable economics of renewable biofuels, even including greenhouse gas credits.

Table ES4: Summary of annual costs, including financing, of the microalgae biofuel cases

Case	Electricity production credit ^A	Operating expenses ^B	Capital charge ^C	Cost of production w/o wastewater treatment credit	Wastewater treatment credit ^D	Overall cost of production
1	\$831,000	\$2,960,000	\$3,170,000	(\$417)/bbl	\$4,950,000	(\$28)/bbl
2	See cost of production	\$1,590,000	\$2,310,000	(\$0.62)/kWh	\$4,950,000	\$0.17/kWh ^E
3	\$554,000	\$2,810,000	\$2,720,000	(\$405)/bbl	\$702,000	(\$332)/bbl
4	See cost of production	\$1,470,000	\$1,890,000	(\$0.89)/kWh	\$627,000	(\$0.72)/kWh
5	\$2,222,000	\$8,090,000	\$9,020,000	(\$302)/bbl	\$3,030,000	(\$240)/bbl

- A. Gross electricity produced from biogas, valued at \$0.10/kWh. For biogas-only cases, the electricity credit is considered in the cost of production.
- B. Excludes Electricity Production Credit and includes Table ES3 Electricity Purchase cost.
- C. At 8%, including bond repayment and depreciation.
- D. Based on average US wastewater treatment fees for biochemical oxygen demand mass removal. Revenue does not include a premium for nutrient removal.
- E. The lack of parenthesis indicates that revenue from wastewater treatment is greater than the total cost of the operating expenses and capital charges for the facility.

Options for Improving Process Economics and Resource Potential

The cases that emphasize wastewater treatment are able to produce cost-competitive biofuels. However, at a national scale, the need for locations in sunny climates with access to sufficient flat land and supplemental CO₂, in addition to wastewater, will severely limit the application of these cases. Although, a significant number of combined algae wastewater treatment-biofuels facilities could be located in the US, as evidenced by the over 8,000 existing wastewater ponds in the US, their aggregate contribution to US liquid fuel resources would be minor—at best a small fraction of 1% of total demand. Additional resources and improved economics are needed.

The wastewater limitation could be removed entirely by using purchased nutrients and water. If water is available at low cost (e.g., seawater, brackish water, even fresh water in some locations), overall operating expenses are not likely to increase more than about 10%, mainly due to fertilizer purchase. Yet, without wastewater treatment credit, the unit cost of oil or electricity would be about 20-25% higher than shown in the final column of Table ES4 for Cases 3-5. Even when released from the need for wastewater, the other facility siting limitations (climate, water, flat land, and CO₂ source) will still restrict the contribution of microalgae biofuels to likely about 1% of total US liquid fuel consumption. However, focused on special markets (e.g., biodiesel and renewable aviation fuel), even one or two billion gallons per year would be a significant supply. In general, a future biofuels industry will require a multitude of feedstocks, including algae.

Significant improvements in production costs over those presented herein are likely possible through further advances in both biology and engineering research. In engineering, the most significant cost reductions would come in the area of biomass processing (e.g., harvesting by bioflocculation and oil extraction from wet biomass). As an example of the impact of the latter, in Case 5, a large central oil extraction plant is fed by fifty 400-ha farms, which would require wastewater from a population of 5 million (or other equivalent wastes). Five million people is the combined population of San Diego and Riverside Counties, near the envisioned farm sites. Distributed farms in such a large area would lead to long biomass hauls, increasing cost and lower the environmental benefit of the effort. Development of affordable small-scale, on-site oil recovery technologies would decrease the need for trucking biomass. Wet biomass oil recovery by cell disruption, emulsification and centrifugation would be one example of such a technology. If the drying, hauling, and extraction costs of Case 5 decreased by two-thirds, oil cost would decrease by about 15-20%.

Cultivation and engineering research is also needed to lower costs through, for example, better control of zooplankton grazers and development of lower cost ponds, clarifiers, and digesters. These improvements, which are possible in the near-term and are already assumed in the cost projections of this report, decrease the facility costs by several-fold compared to conventional wastewater treatment and biomass harvesting designs that use concrete tanks. These engineering advances do remain to be developed, however. Since photobioreactors are inherently impractical for scale-up and would be used only in seed culture production, research on their design is unlikely to have much impact.

The major opportunity for lowering costs and extending the feasible geographic range of algae biofuels is in biological research. Increases in biomass and oil productivity (tons/ha-yr) above the projections of this study should be possible through strain selection and genetic improvements and modifications of the algae. One promising approach is the use of strains

with reduced pigment content, which would lessen the major factors decreasing the productivity of algae mass cultures, that is, self-shading and the light saturation of photosynthesis. However, the survival and prolonged dominance of such improved strains in the outdoor mass culture environment will require extensive research and advances in culture management. Increasing productivity requires increasing the size and cost of many of capital items needed to handle the additional biomass, plus additional fertilizer. Thus, a doubling of productivity in Cases 3-5 would decrease the total unit cost of oil or electricity shown in the last column of Table ES4 by about 30-35%. No credit for nutrient removal from wastewater is considered in this report.

Combining the above projected cost factors: increase due to fertilizer purchase to replace wastewater nutrients (+10%), absence of wastewater treatment credit (+20 to +25%), decrease due to on-site algae oil extraction (-15 to -20%), and doubling of productivity (-30 to -35%), the overall potential for cost reduction would be at most about -25%. To achieve reasonable net production costs while being independent from wastewater treatment, alternative revenue would be needed. Other than wastewater treatment, the only co-product market of substantial size is animal feed. Since the solvent extraction process assumed in the present study requires biomass drying, diversion of the post-extraction biomass to feed does not require major additional effort. The carbon and nutrients in the diverted biomass would no longer be recycled for algae growth and would need to be obtained elsewhere (e.g., purchase of nitrogen and phosphorus fertilizer and provision of flue gas CO₂ to satisfy the entire algae demand). With those assumptions, and if the residual biomass is valued equally with soy meal (\$400/mt), Case 5 would produce algae oil with a cost of about \$150/bbl. In the long-term with a doubling in algae productivity, the feed and fuel scenario would lead to a cost of about \$30/bbl. Of course, these estimates are approximate, but they illustrate the potential of long-term research to improve the prospects for microalgae biofuel production.

In conclusion, even with only an 8% capital charge as applied here, this analysis does not project a favorable outcome for near-term, large-scale algae biofuels production without wastewater treatment as the primary goal. For larger systems, longer-term R&D to improve productivity, cultivation, and biomass processing could reduce the costs of microalgae biofuels to competitive levels with co-product revenue. Research advances could also expand the resource potential of this technology, and future analysis of these longer-term options is required.

Conclusions

The results of the present study, based on a detailed *de novo* analysis, project high costs for microalgae biofuels produced by facilities designed primarily for biofuels production. Even with

low capital charges, it is not possible to produce microalgae biofuels cost-competitively with fossil fuels, or even with other biofuels, without major advances in technology.

Prior studies (e.g., Benemann and Oswald, 1996; Benemann et al., 1982; and Weissman and Goebel, 1987) also concluded that algae production using the best available strains and cultivation methods (20 g/m²-d annual productivity at 25% oil content) would not be economically feasible for biofuels. Benemann and Oswald (1996) based their analysis on three-times this oil output (30 g/m²-d, 50% oil). Their hypothetical process used a low-cost but as yet unproven method of oil extraction (cell breakage with oil emulsification and centrifugation) and many other favorable assumptions, such as large scales, no water costs, etc. With these assumptions, they arrived at a cost of about \$100/barrel oil (current dollars). However, these prior studies and the present one are not directly comparable due to major process differences: use of purchased nutrients vs. wastewater nutrients, use of batch vs. continuous harvesting, and oil extraction from wet vs. dry biomass, among others.

All techno-economic assessments of algae biofuels are necessarily based on assumed processes for harvesting and oil recovery, as well as microalgae biomass productivity and oil content. These are the assumptions that R&D has to address.

As concluded above, the major area for long-term cost improvements is in biology: the goal being to at least double biomass and oil productivity through strain selection and genetic modification. These strains must then be cultivated reliably in the outdoor ponds and harvested cheaply—major challenges that may require a decade's effort or longer to become practical.

Additional cost reductions will need to come from engineering improvements in essentially all system components, such as in reactor construction, harvesting, dewatering, and oil recovery. Such advances must be proven in pilot-scale (~10 ha) production systems. The favorable economics of microalgae production for biofuel in conjunction with wastewater treatment could allow for practical, near-term development of engineering, technological, and human resources in this field.

Finally, even with such advances, the resource potential of microalgae biofuels will always be modest, mainly due to the lack of sites having all the needed resources, in particular available CO₂. Over the long run, land-use planning to create specific locations where the needed resources coincide can help build capacity and allow algae oil to make a vital, even if modest, contribution to a US biofuels industry.

Endnote: Financial Assumptions Used in Cost Estimation

Cost projections are highly sensitive to many financial assumptions, in particular to debt: equity ratios, interest rates for debt, inflation assumptions, tax rates, overheads, etc. For the current analysis, the entire capital investment is assumed to be financed as debt, and the main financial metric is the calculated cost of production per barrel of oil or kilowatt-hour of electricity produced. This cost of production excludes costs such as taxes, profits, corporate home office overheads and includes revenue from wastewater treatment fees and electricity sales.

In this report, a 5%, 30-year bond to fund facility construction is assumed. Only a mature, essentially risk-free technology would be financed at this rate. Further, the process would have to be inflation-neutral (i.e., income and expenses rise equally with inflation). These conditions would be applicable to the present cases where municipal wastes are treated. A further 3% per annum charge is added for depreciation on total facility cost, based on an average of the different useful lives of the various depreciable assets. A combined capital charge of 8% is thus used in this report to cover capital costs. At the end of the 30-year bond term, the plant would be fully amortized, debt-free, and with sufficient funding set aside for complete renovation. Further details and discussion of the financial assumptions and results are given in Chapter 5.

ACKNOWLEDGMENTS

The authors greatly appreciate the assistance of the following individuals in collecting information and otherwise facilitating the preparation of this report.

Chris Somerville, Susan Jenkins, Heather Youngs, Martin Carrera,
Trisha Togonon, and Anne Krysiak
Energy Biosciences Institute, Berkeley, California

Richard W. Ozer
Crown Iron Works Company, Minneapolis, Minnesota

Robert Dibble
Mechanical Engineering, University of California, Berkeley

Nick Erlandson
Capital Accounting Partners, LLC, Sacramento, California

Ed Hale
Custom Harvest, Brawley, California

Andre Harvey
CLI-ClearWater Construction, Spring Valley, California

Charlie McElvany
McElvany Construction, Los Banos, California

Terri Dunahay
Biotechnology Regulatory Services, Animal and Plant Health Inspection Service, USDA

Rich ten Bosch
Black and Veatch Engineers

Ken Hoffman
Sanitation Districts of Los Angeles County

Dan Frost
Carollo Engineers

and

The Participants in the Panel Meetings at U.C. Berkeley, January 2009 (listed in the Appendix)

TABLE OF CONTENTS

EXECUTIVE SUMMARY	i
ACKNOWLEDGMENTS	xiv
TABLE OF CONTENTS.....	xv
LIST OF TABLES.....	xix
LIST OF FIGURES.....	xxi
CHAPTER 1 INTRODUCTION	1
CHAPTER 2 BIOLOGY AND BIOTECHNOLOGY OF MICROALGAE	3
2.1 Current and Potential Uses of Microalgae Biomass	3
2.1.1 Commercial Microalgae Production	3
2.1.2 Microalgae Wastewater Treatment.....	6
2.1.3 Foods, Feeds and Commodities	9
2.2 Algae Biomass Type, Quality, and Technologies	10
2.2.1. Algae Types and Phycology	10
2.2.2. Composition of Algae Biomass and Oil Content	11
2.2.3. Algae Production Systems: Ponds and Photobioreactors.....	13
2.3 Algae Biomass Productivity	14
2.3.1. Maximum Theoretical Solar Conversion Efficiency.....	14
2.3.2. The Practical Limits to Algae Solar Conversion Efficiency.....	15
2.3.3. Genetic Approaches to Increasing Algae Solar Conversion Efficiency.....	17
2.3.4 Theoretical and Practical Limits of Algae Biomass Productivity	18
2.3.5. Oil Content and Productivity in Algae Mass Cultures	19
2.3.6. Supply of CO ₂ and Other Nutrients	20

2.3.7. Temperature Limitation on Productivity.....	21
2.3.8. Selection for Improved Microalgae Strains.....	22
2.3.9. Genetically Modified Algae- GMA.....	23
CHAPTER 3 ALGAE BIOFUELS – ENGINEERING CONSIDERATIONS.....	25
3.1 Algae Biofuels: Production a Brief History	25
3.1.1. Initial Work at the University of California, Berkeley	25
3.1.2. The Aquatic Species Program (ASP)	27
3.1.3. Recent Developments in Algae Biofuels	30
3.2. Cultivation Systems	31
3.2.1 Open Ponds – Design and Operations Limitations.....	31
3.2.2. Closed Photobioreactors (PBR)	33
CHAPTER 4: RESOURCES AND REGULATIONS.....	35
4.1 Resources Contraints and Opportunities	35
4.2 Climate.....	36
4.2.1. Temperature and Solar Irradiation	36
4.2.2. Evaporation	38
4.2.3. Water and Nutrient Resources	40
4.2.4. Land Resources.....	44
4.2.5. Carbon Dioxide	46
4.3 GIS Analysis for Algae Biofuel Production in California.....	49
4.4. Environmental Impacts And Regulatory Issues	56
CHAPTER 5: ENGINEERING DESIGNS AND COST ESTIMATES.....	58
5.1 Concept and Assumptions.....	58
5.2 Description of The Five Facility Cases.....	60
5.3 Location and Site Descriptions	61

5.4 Algae Cultivation and Fuel Yield Assumptions	64
5.5 High-Rate Pond Layout, CO ₂ Delivery and Construction	69
5.5.1 General HRP Design Considerations	69
5.5.2 Liner Requirement and Costs	78
5.5.3 CO ₂ Delivery and pH Limitations	79
5.6 Overview of Individual Case Studies	80
5.6.1 Cases 1 and 2: Wastewater Treatment-Emphasis Facilities; 100-ha Facility Base Case.....	81
5.6.2 Nutrient and Carbon Balance, Parasitic Energy, Outputs	91
5.7 Cost Estimating Method	99
5.7.1 Accuracy of the Estimate.....	100
5.7.2 Comparison of Municipal and Agricultural Facility Costs	100
5.7.3 Construction Cost Multipliers	102
5.7.4 Solvent Extraction Facility Costs	105
5.7.5 Depreciation: Generic Costing Method	106
5.7.6 Source of Capital Payment Terms: Generic Cost Method	106
5.7.7 Operators and Administration	106
5.8 Cost Analysis Case 1 and Case 2	107
5.8.1 Capital Cost Results.....	107
5.8.2 Operating Expenses and Revenue.....	109
5.8.3 Financial Summary for Case 1	110
5.8.4 Case 2 Cost Analysis	111
5.9 Case 3 and 4: Biofuel-Emphasis Facilities; 100-ha Facilities	114
5.9.1 Engineering Facility Design.....	114

5.9.2 Operations: Operators, Administration, Nutrient and Carbon Balance, Outputs.....	115
5.9.3 Case 3 Cost Analysis	119
5.9.4 Case 4 Cost Analysis	121
5.10 Case 5: Biofuel-Emphasis + Oil, 400 ha	122
5.11 Cost Comparison and Analysis Sensitivities	128
CHAPTER 6. CONCLUSIONS AND R&D RECOMMENDATIONS	131
6.1. Biofuels and Co-Products	131
6.2. The Current State of The Algae biofuels Industry	131
6.3. R&D Needs and Time Frame	133
WORKS CITED.....	136
APPENDIX 1: PANEL MEETINGS	145
Executive Summary	145
Background	145
Purpose of the Workshops	145
Agenda.....	146
APPENDIX 2: SOLVENT EXTRACTION PROCESS DESCRIPTION	150

LIST OF TABLES

Table 4.1: Typical resource needs for a typical outdoor algae biomass production facility.	43
Table 4.2: Identified Stationary CO ₂ Sources from the NATCARB 2008 Stationary CO ₂	47
Table 4.3: Classified data by range of values using natural breaks..	53
Table 4.4: Cost breakdown affecting the weights assigned to different GIS coverages.	54
Table 4.5: Weighting scheme used for all relevant GIS data.....	54
Table 5.1: The five general case studies considered in this report	60
Table 5.2: Hydraulic retention times and influent flows for each case.....	68
Table 5.3: Cost comparison between plastic-lined and a clay-lined 4-ha high rate ponds	78
Table 5.4: Wastewater characteristics and removal efficiencies	85
Table 5.5: Heating, electrical, and staffing requirement of solvent extraction facilities handling either 105 or 4,000 mt/d amounts of biomass.....	92
Table 5.6: Gross energy production for Cases 1 and 2.	97
Table 5.7: Comparison of unit capital costs for municipal and agricultural engineering design standards for components needed in an algae biofuel plant.	102
Table 5.8: Algae biomass processing equipment installation cost multipliers.....	103
Table 5.9: Cost multipliers on construction cost subtotals for all cases. ¹	104
Table 5.10: Extraction facility total and shared operational and capital costs	105
Table 5.11: Administrative personnel costs for a 100-ha facility	107
Table 5.12: Operations personnel cost for a 100-ha facility.....	107
Table 5.13: Capital cost for Case 1 (wastewater treatment-emphasis + oil).....	108
Table 5.14: Operating expense for Case 1 (wastewater treatment-emphasis + oil).....	110

Table 5.15: Summary of financial model for Case 1 (wastewater treatment-emphasis + oil).	111
Table 5.16: Summary of capital costs for Case 2 (wastewater treatment-emphasis + biogas).....	112
Table 5.17: Operating expense for Case 2 (wastewater treatment-emphasis + biogas)	113
Table 5.18: Summary of financial model for Case 2 (wastewater treatment-emphasis + biogas).....	113
Table 5.19: Gross energy production for Cases 3 and 4	117
Table 5.20: Summary of capital costs for Case 3 (biofuel-emphasis + oil)	120
Table 5.21: Summary of financial model for Case 3 (biofuel-emphasis + oil)	121
Table 5.22: Summary of capital costs for Case 4 (biofuel-emphasis + biogas).....	121
Table 5.23: Summary of financial model for Case 4 (biofuel-emphasis + biogas).....	122
Table 5.24: Gross energy production for Case 5 (biofuel-emphasis + oil, 400 ha).....	123
Table 5.25: Summary of capital costs for Case 5 (biofuel-emphasis + oil, 400 ha)	126
Table 5.26: Summary of financial model for Case 5 (biofuel-emphasis + oil, 400 ha)	127
Table 5.27: Financial summary for individual case studies.	128
Table 5.28: Total cost of production when including wastewater treatment cash generation (revenue) from BOD removal.....	129

LIST OF FIGURES

Figure 1.1: Micrographs of commercially cultivated algae species.....	1
Figure 2.1 and Figure 2.2: Commercial microalgae production in open raceway paddle-wheel mixed ponds.....	4
Figure 2.3: <i>Dunaliella salina</i> ponds in Australia.....	5
Figure 2.4: <i>Haematococcus pluvialis</i> production, tubular photobioreactors.....	5
Figure 2.5: Oxidation Pond for Wastewater Treatment.....	6
Figure 2.6: Typical paddle wheel installation.	6
Figure 2.7: First Algae Mass Culture Experiments on a Rooftop at MIT.....	12
Figure 2.8 and Figure 2.9: Dome reactors and Circular ponds.	14
Figure 3.1: Algae- Methane–Electricity Process Schematic.....	25
Figure 3.2: High Rate Ponds at the “Sanitary Engineering Research Laboratory” (SERL), Univ. California, Berkeley, ca. 1994.	27
Figure 3.3: Artist Conception of an Algae-Oil production Process.	28
Figure 3.4: The Roswell, NM, Algae Test Facility.	29
Figure 3.5: Christchurch New Zealand, High Rate Ponds	32
Figure 4.1. Schematic of an algae biofuel production process (Harmelen and Oonk, 2006).....	35
Figure 4.2: Temperature zones projected to be suitable for algae biofuel feedstock production corresponding to an annual average temperatures of above 15°C	36
Figure 4.3: Seasonal minimum temperatures for algae biomass production within the US.	37
Figure 4.4: Annual average horizontal solar radiation for the continental US (NREL, 2008).	38

Figure 4.5: Annual average pan evaporation rates for the US	39
Figure 4.6: The current state of groundwater aquifers within the continental US showing areas of acute stress (where withdrawal exceeds recharge), areas impacted by groundwater pumping and areas affected by salinity intrusion.	41
Figure 4.7: Saline aquifers in the continental US Brown shading refers to the depth of the aquifer. With appropriate treatment, inland brackish water resources could be an important source of water for algae biofuel production.	41
Figure 4.8: Map of produced water resources from energy mineral extraction	42
Figure 4.9: Land areas (green) located at altitudes lower than 500 m (1500 ft), assumed to encompass most areas with moderate slopes.....	45
Figure 4.10: Areas with 1 km ² (100 ha) areas of flat land located with less than 5% slope in the continental US	46
Figure 4.11: US CO ₂ emissions sources – size of circular dots is scaled according to the size of the emission source.....	49
Figure 4.12: Results from a weighted GIS coverage overlay model showing suitable locations.....	55
Figure 5.1: Proposed location for algae facilities in California and photographs of two algae production facilities in this area.....	62
Figure 5.2: Average insolation per 24-hr day at Brawley, Imperial County, California	62
Figure 5.3: Net monthly evaporation for Imperial County	63
Figure 5.4: Green areas indicate where in Imperial County the soils have enough clay content to allow them to be used as wastewater lagoon lining material.....	64
Figure 5.5: Assumed daily areal biomass productivity on a monthly average basis.	65
Figure 5.6: Assumed maximum hourly algae biomass productivities in each month.....	67
Figure 5.7: Plan view of an individual 4-ha high rate pond.	70
Figure 5.8: Section view of a 4-ha high rate pond through paddle wheel station.	70
Figure 5.9: Counter current sump for flue-gas transfer to algae ponds.....	71

Figure 5.10: Energy consumption to overcome head losses from friction along the length of the channels, the 180° bends and two sumps, as a function of flow velocity for a 4-ha pond.	72
Figure 5.11: Case 1 site layout showing 100-ha of high rate algae ponds, drying beds, and dry algae storage silos.....	76
Figure 5.12: Close up on center components of 100-ha facility Case 1	77
Figure 5.13: Case 1 Process Schematic (wastewater treatment-emphasis and oil production).	82
Figure 5.14: Case 2 Process Schematic (wastewater treatment-and biogas production).	82
Figure 5.15: Parasitic energy requirements.....	93
Figure 5.16: Parasitic energy requirements breakdown by operation.....	94
Figure 5.17: Case 1. CO ₂ Requirement and CO ₂ produced onsite.	95
Figure 5.18: Case 2. CO ₂ Requirement and CO ₂ produced onsite.	96
Figure 5.19: Simplified mass balance for Case 1 (Wastewater treatment-emphasis + oil), showing seasonal variations and fuel and electricity production.	98
Figure 5.20: Simplified mass balance for Case 2 (Wastewater treatment-emphasis + biogas), showing seasonal and electricity production.....	99
Figure 5.21: Capital cost components for Case 1 (wastewater treatment-emphasis + oil).	109
Figure 5.22: Process schematic for Case 3 (biofuel-emphasis + oil).....	114
Figure 5.23: Process schematic for Case 4 (biofuel-emphasis + biogas)	115
Figure 5.24: Case 3 CO ₂ requirement and CO ₂ produced onsite..	116
Figure 5.25: Case 4 CO ₂ requirement and CO ₂ produced onsite.	116
Figure 5.26: Simplified mass balance for Case 3 (biofuel-emphasis + oil), showing seasonal variations.....	118
Figure 5.27: Simplified mass balance for Case 4 (biofuel-emphasis + biogas), showing seasonal variations.....	119

Figure 5.28: Simplified mass balance for Case 5 (biofuel-emphasis + oil, 400 ha), showing seasonal variations..... 123

Figure 5.29: Water, biomass, and nutrient mass balance for Case 5. Annual average and maximum flows are shown..... 125

CHAPTER 1 INTRODUCTION

This report addresses the technology and economics of production of biofuels using microalgae. Algae are all non-vascular plants (e.g. without a specialized nutrient distribution system) and include the macroalgae, or seaweeds, and microalgae. Although there is no formal definition for the term microalgae, these are generally meant to include all algae too small to be seen clearly with the unaided eye. The term microalgae, as used herein, includes the prokaryotic cyanobacteria and the eukaryotes, green algae and diatoms, among other types (Figure 1.1).

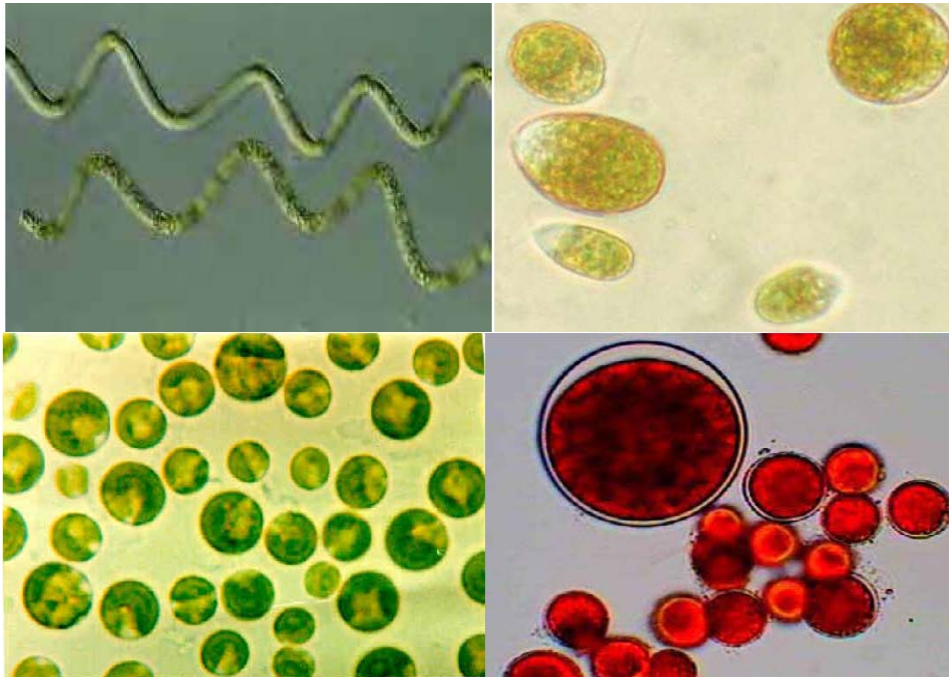

Figure 1.1: Micrographs of commercially cultivated algae species.

Top left, *Spirulina* (*Arthrospira platensis*). Top right, *Dunaliella salina*. Bottom left, *Chlorella vulgaris*. Bottom right, *Haematococcus pluvialis*. *Spirulina* are cyanobacteria and the other three are green algae (Chlorophyceae).

Although microalgae carry out oxygenic photosynthesis (e.g. split water to produce O₂ and fix CO₂ into biomass using sunlight), many can also use organic substrates (e.g. glucose, acetic acid, etc.) in the light or dark (respectively mixotrophic and heterotrophic growth), and some have even evolved (or reverted) to non-photosynthetic, pigment-less species living permanently in the dark. In this report, we only consider oxygenic photosynthetic microalgae for biofuels production. Macroalgae (seaweeds) are also being proposed for biofuels (methane, ethanol, butanol) production (Huesemann et al., 2010), but their cultivation is fundamentally different

from microalgae, and thus macroalgae are not included in this analysis. (In the remainder of this report, the term “algae” refers only to microalgae.)

The primary focus of this report is on the potential of microalgae for liquid transportation fuels.

Methane is addressed primarily as by-product of liquid fuels production, specifically algae vegetable-type oils suitable for biodiesel production. Ethanol and higher alcohols and hydrogen are all produced by microalgae, but they are not discussed herein, as their research has lagged that of algae oils. For hydrogen, development has not yet advanced beyond the laboratory or conceptual stage (Benemann, et al., 2005). However, longer-term possibilities in this field should not be excluded from other analyses.

High value co-products, such as nutritional supplements, currently the main commercial microalgae products, are not of interest in large-scale biofuels production, as their markets are too small to be relevant. Commodity animal feeds, with prices similar, though somewhat higher, than those of liquid biofuels, provides potential synergies, and most current schemes for algae biofuels production rely on some type of commodity feed by-product. However, such co-production of biofuels and animal feeds is problematic in that producers may prefer to sell the entire algae biomass for feeds, without oil extraction.

Another model for co-products with algae biofuel production is wastewater treatment, where process requirements and objectives coincide sufficiently so as to make a combined process potentially viable. In this report we focused on combining municipal wastewater treatment with algae biofuels production as the most plausible model for biofuels production in the near-term, with either algae biofuels or wastewater treatment the primary process objective. This report provides a detailed engineering-economic analysis of algae liquid biofuels production, following on prior such analyses in this field (e.g. Benemann et al., 1982; Weissman and Goebel, 1987; Benemann and Oswald, 1996). The same type of algae production process, based on paddle wheel mixed ponds, was used, but many design detail differed from earlier studies.

Five cases are analyzed herein, with the first two having wastewater treatment as the main objective with algae oil and methane as co-products. The other three cases have algae biofuels as the main objective, with wastes providing nutrients and water and some waste treatment credits. At a large scale and in the longer-term, wastewater use would be optional and such processes could be operated with agricultural fertilizers and other water sources. We briefly address the resource requirements for a future US algae biofuels industry (see also Wigmosta et al., 2009). We conclude with an R&D needs assessment, based in part on the conclusions from a technical workshop by experts in the field (see also US DOE, 2009). We do not review the literature on algae biofuels in detail. Recent reviews include Wang et al., 2008; Brooijmans and Siezen, 2010; Grobbelaar, 2010; Kumar et al., 2010; Martins and Caetano, 2010; Singh and Gu, 2010; Tredici, 2010; Gouveia and Oliveira, 2009; and Sialve et al., 2009).

CHAPTER 2 BIOLOGY AND BIOTECHNOLOGY OF MICROALGAE

2.1 CURRENT AND POTENTIAL USES OF MICROALGAE BIOMASS

2.1.1 COMMERCIAL MICROALGAE PRODUCTION

A small industry for the cultivation and industrial scale production of microalgae has evolved over the past fifty years. The industry originated with research in the US, Japan, Germany and other countries for food production using microalgae (Burlew, 1953), which led to the first industrial scale production of microalgae for human consumption (nutritional supplements) in Japan in the early 1960s. The microalga produced commercially was *Chlorella*, a small green alga (Figure 1.1), cultivated in open, circular ponds (see Section 2.2.2). Cultivation typically required a large volume of seed culture (inoculum) to ensure purity of the cultures. Harvesting and drying the biomass uses expensive centrifuges and spray dryers, and the cells then need to be broken (typically using ball mills). About 5,000 mt of *Chlorella* biomass, selling for ~\$20,000/mt (plant gate) is currently being produced worldwide, mainly in Japan and Taiwan. There is a great diversity in production systems, with circular ponds, paddle wheel mixed raceway ponds, tubular photobioreactors (PBRs, in Germany) and fermentation processes all being used in commercial production. Some producers using open pond systems feed the algae acetate, which make them grow faster. Such mixotrophic production has also been suggested for biofuels production. However, such processes are limited by the relatively high cost of the substrate and problems associated with bacterial consumption of the substrate.

The next microalga successfully produced commercially in large quantities was Spirulina (a cyanobacteria, *Arthrospira platensis*). Discovered during the 1960s to be a traditional food of people living around the alkaline Lake Chad in Africa, the first commercial Spirulina production plant was in operation at a large bicarbonate evaporation basin near Mexico City by the early 1970s (although it closed in 1995 for reasons unrelated to its algae production business). Spirulina has several major advantages over *Chlorella*: when grown in a high bicarbonate medium it is not easily contaminated, requiring little inoculum; its filamentous nature makes it easy to harvest with screens; and, unlike *Chlorella*, it is highly digestible, and thus requires no cell disruption for use as a food or feed. Spirulina production was also developed in other countries, including the US, with Earthrise Nutritionals, LLC (now a subsidiary of a Japanese company), establishing the first production plant in the early 1980s near the Salton Sea, Calif. (Figure 2.1), followed by Cyanotech Corp. in Kona, Hawaii (Cyanotech, Figure 2.2).



Figure 2.1 and Figure 2.2: Commercial microalgae production in open raceway paddle-wheel mixed ponds.

**Figure 2.1: Left, Earthrise Nutritionals, LLC, California. *Spirulina* production, Ponds ~ 1 acre.
Figure 2.2: Right, Cyanotech Co., Hawaii, producing *Haematococcus pluvialis* (red ponds) and *Spirulina*.**

These two plants, producing together about 1000 mt per year of dried algae biomass, were the main producers until about a ten years ago, when *Spirulina* production underwent a major boom in China, bringing world production to close to 5000 mt per year. Other *Spirulina* production systems are operating in India, Myanmar, and a few other countries. *Spirulina* sells, plant gate, for about \$10,000 per ton and higher, depending on quality and origin and is used mainly as a food supplement (Gershwin and Belay, 2007). All commercial *Spirulina* production currently uses open, shallow, paddle wheel-mixed, raceway ponds.

Two more microalgae species are currently produced industrially in significant quantities: *Dunaliella salina* (Figure 1.1) and *Haematococcus pluvialis* (Figure 1.1), sources of high value carotenoids, beta-carotene and astaxanthin, respectively. *Dunaliella salina* is produced for its high beta-carotene, a pro-vitamin A, content, and is cultivated using a hypersaline growth medium (~100 g/l of salt!, >3 times seawater), which discourages most competing algae and grazers, while inducing a high content of carotenoids within the algae cell. In Australia, large-scale (hundreds of acres), shallow, open, unmixed ponds are used (Figure 2.3), while in Israel this alga is produced with the same design paddle-wheel mixed ponds used for *Spirulina* cultivation. The Australian process is less productive but has lower cost, due in part to the low cost of land there. Harvesting methods differ in the two processes: in Australia the cells are absorbed on small plastic particles with an iron core, followed by high gradient magnetic

separation, while in Israel the biomass is recovered by centrifugation. World production of *Dunaliella* is estimated at about 1000 mt/yr of biomass, containing 4-5% beta-carotene.



Figure 2.3 and Figure 2.4 Commercial algae production facilities for *Dunaliella* and *Haematococcus*.

Figure 2.3: Left, *Dunaliella salina* ponds in Australia (Cognis-Betatene). Each pond is ~50 ha.

Figure 2.4: Right, *Haematococcus pluvialis* production in tubular photobioreactors. Each tube is about 100-m long and 5-cm in diameter (Algatech Co., Israel).

Haematococcus pluvialis production uses freshwater in both closed photobioreactors of various configurations (Figure 2.4) using sunlight or even artificial lights and in open ponds (Figure 2.3). The algae settle readily after astaxanthin production is induced by nutrient limitation. Open ponds are less costly than closed photobioreactors, though more easily contaminated and likely less productive. Economics favor the open ponds, even though this algae biomass sells, plant gate, for >\$100,000/mt (with a 2% astaxanthin content). *Haematococcus* production is currently estimated at only 100 mt/yr worldwide, a reflection of difficulties with its cultivation and limited market as a high-value human nutritional supplement. The aquaculture feed market (for coloring salmon with astaxanthin) could be several thousand tons, if produced for under ~\$10,000/mt.

The fact that both *Chlorella* and *Haematococcus* are being grown commercially in outdoor open ponds, where the cultures are readily invaded by other algae or zooplankton grazers, provides some comfort to the vision of open pond production of microalgae for biofuels. However, the relatively modest scale of these cultivation processes and the high cost of the algae biomass produced, suggests that considerable advances in the technology will be required. However, such advances are plausible: for *Haematococcus* production, the scale of the inoculation systems appears to have been dramatically reduced in the open pond operations, as experience

was gained. Similarly, for *Spirulina* productivity has increased and costs decreased over the years.

A similar open pond process, also using an inoculum system (but limited to less than ~1% of total biomass output), has been proposed for algae biofuel production. Such systems must be larger, have higher productivities, and be of much lower cost than current commercial algae production. The concept is to use a sequence of inoculum reactors of increasing scale (nominally ten-fold scale-up at each stage) and decreasing sophistication and cost, to build up culture inoculum for large, unlined, outdoor, paddle wheel-mixed raceway ponds (Benemann and Oswald, 1996). The inoculum reactors could be photobioreactors at the smallest stage, followed by ponds that are covered and lined. This is the basic concept for the large-scale microalgae for biofuels on which the present report is based.

2.1.2 MICROALGAE WASTEWATER TREATMENT

Several thousand small (< 10-hectare) and a few large-scale (>100-hectare) algae pond systems are currently operated for municipal wastewater treatment in the US (Figure 2.5). The essential function of the algae is to provide dissolved oxygen for the bacterial breakdown of the wastes. The common alternative to ponds is mechanical wastewater treatment in which oxygen is provided by mechanical aeration (e.g., activated sludge process). One key issue for treatment ponds is the harvesting of the algae biomass, which is technically feasible using chemical



Figure 2.5 and Figure 2.6 Municipal wastewater treatment facilities.

Figure 2.5: Left, Oxidation pond for wastewater treatment (~100 ha, Napa, California).

Figure 2.6: Right, Typical paddle wheel installation.

flocculants, but expensive, mainly due to the high cost of the flocculants required. Thus, algae harvesting is only practiced at some of the larger pond systems (as in Figure 2.5). Also, the

chemical flocculants make it more difficult to beneficially using the biomass, for example for anaerobic digestion to produce methane gas. Further, algae pond systems require considerable land, typically one acre per 100 - 200 persons, depending on location (higher latitudes require more land). Land limitations near most population centers, and the currently high cost of removing algae from the effluents, reduces the appeal of these systems.

If a low-cost algae harvesting process could be developed, municipal wastewater treatment using microalgae would be much more appealing. However, research on algae harvesting and algae removal has been ongoing for 50 years without development of a technology sufficiently low cost for biofuels production. One approach could be to mimic the activated sludge process, in which the bacterial biomass generated during aeration of the waste is removed by sedimentation—a low-cost process. This, however, is not possible with conventional oxidation ponds, which are large, unmixed, and thus heterogeneous systems, where there is no possibility to manage the algae culture. Only with raceway, mechanically-mixed ponds is it possible to control the algae process in similar fashion to the activated sludge process. A few such ponds have been built, mostly in California, but are not widely used due to the problem of separating the algae from the effluents. Although settling of microalgae from pilot-scale high rate wastewater treatment systems was investigated some time ago (Benemann et al., 1980), this process remains to be demonstrated at scale (see below). The current focus on global warming, energy security and biofuels production have again brought the problem of low-cost algae harvesting to the forefront, and encouraged further research in this field.

Another major development has been the change in emphasis in wastewater treatment technology from simply oxidizing the organic matter in the waste (i.e., removing the biological oxygen demand, BOD) to removing nutrients, specifically N and P, which are the root causes of eutrophication of inland waterways and coastal dead zones. The need for nutrient removal greatly improves the prospects for using ponds in wastewater treatment, as microalgae are particularly efficient in capturing and removing such nutrients, something that conventional treatment processes (such as variants of the activated sludge process) can do at only relatively high cost. The prospect of algae nutrient removal has revived interest in this field, with recent research demonstrating that microalgae can remove both N and P from wastewaters over a large range in ratios and concentrations, by supplementing the cultures with CO₂ (Lundquist et al., 2009). This process greatly increases the amount of algae biomass produced and provides an opportunity for combining algae biomass production in wastewater treatment with algae biofuels production.

The economic benefits resulting from municipal wastewater treatment, make this the most cost-effective strategy to fast-track development of practical algae biofuels production process, and, thus is a particular focus of the present report. Two cases are analyzed herein: (a) a

wastewater treatment process with co-production of an algae biofuel and (b) a microalgae biofuels production process in which municipal wastewater is used to supply water and nutrients to the process, with wastewater treatment being incidental the process. Municipal wastewater has several major advantages as a resource in the production of algae biofuels:

- (1) It is produced in substantial quantities (~100 gallons/person-d) and is collected at a single location.
- (2) It contains sufficient N (~30 – 40 mg/L), and P (~5 – 10 mg/L) and other essential micronutrients to produce large amounts of algae biomass.
- (3) It contains substantial amounts of the C needed for algae growth.
- (4) The algae can remove essentially all the nutrients present in the wastewater, achieving a high degree of treatment.
- (5) There is a monetary return to the process of treating sewage, which could be several-fold greater than the value of the fuels derived from the biomass.
- (6) The greenhouse gas abatement benefits are several-fold those of biofuels alone, due to reduction in the use of energy compared to conventional treatment processes.
- (7) Algae ponds are already widely used in municipal wastewater treatment, even if most systems are small. However, a few large systems do operate, and algae pond technology is familiar to the wastewater treatment industry.

The algae wastewater treatment technology presented in this report is a process that removes organic and inorganic nutrients while producing biofuels and has a footprint about half the size of current algae pond systems. Land availability and climate constraints limit the potential of such systems in the US and even world-wide. Harmelen and Oonk (2006) estimated a global potential of 30 million tons of algae biomass production, and a similar level of CO₂ abatement credits, using municipal wastewaters, after factoring in land availability, climate and other limitations. However, such systems also derive additional benefits, such as indirect greenhouse gas abatement (compared to the high energy use of conventional treatment technologies) and other environmental services.

Where the objective is primarily algae biofuels production, with municipal wastewaters providing make-up nutrients and water, biofuel production benefits from a reduced need for these resources, while also deriving a modest income from the wastewater treatment function.

2.1.3 FOODS, FEEDS AND COMMODITIES

The major problem with algae biofuels, after demonstrating that the cultivation process can be stable and productive, is the cost of production: it will be difficult for algae biofuel to compete favorably with fossil fuels under current market conditions for the foreseeable future. This economic problem has led to many proposals for technologies to co-produce higher value co-products or animal feeds along with biofuels, as briefly mentioned in the introduction. The higher value co-product approach has some apparent merit. For one example, production of 200 tons of astaxanthin for aquaculture feeds (well over half the present market, currently supplied mainly from synthetic sources), could be extracted from perhaps 10,000 tons of algae biomass, with the residue then used for biofuels, assuming that the residue has sufficient oil to make that worthwhile. However, more plausible than extraction of pigments, would be use of the entire biomass as feed. Also, 10,000 tons of biomass is insignificant in terms of national biofuels programs. Similar examples would be production of other higher value animal feed co-products, such as lutein for chicken feeds, beta-carotene from *Dunaliella*, or fish-meal replacement with marine microalgae. For the latter case, the interest is in both the protein content and omega-3 fatty acids, neither of which is suitable for biofuels and more valuable as animal feed. Indeed, as with other crops, microalgae are more valuable as animal feeds than as fuels.

The analogy can be made with corn fuel ethanol production, where the fermentation residues are dried and sold as animal feed (the distillers dried grains, DDG, or DDGS if the solubles are included). However, the value of this co-product is low (typically not much above \$100/mt), the cost and energy required for drying are high, and few alternatives exist to dispose of this residue. In the case of microalgae, the co-product available after oil extraction could be sold for a higher price. However, the alternative of using this biomass residual as a substrate for anaerobic digestion is likely to be similarly attractive, especially if the digester effluent nutrients and carbon are recycled to the growth ponds. In this case, it can be assumed that the residue is 60% of the biomass, with a 20 MJ/kg energy content. Half of this energy could be recovered as methane. With a methane electricity generation equivalent of 10,000 kJ/kWh and a value of \$0.1/kWh, enough power could be generated to provide an income of \$100/ton of residue, or about the price of DDG. The nutrients in the residue (10% N), at \$500/mt N, is equivalent to another \$50/mt of residue. This recycling also avoids the drying cost of the DDG, a major cost in ethanol production. Thus, anaerobic digestion and power generation could be of lower or equivalent cost compared to the cost of drying and the revenue generated from the feed co-product.

In the case of microalgae, the co-product available after oil extraction might be sold for a higher price than DDG. Algae biomass is often claimed to have a higher value as animal feed than

soybeans. However, the acceptability, digestibility, and nutritive value of algae biomass would need to be evaluated for each case. The algae species, feed application, and the cost of drying need to be included in any assessment of the economic potential of such an approach. In brief, cost effective production of both fuel and feed using the same biomass remains to be demonstrated.

2.2 ALGAE BIOMASS TYPE, QUALITY, AND TECHNOLOGIES

2.2.1. ALGAE TYPES AND PHYCOLOGY

Microalgae are microscopic plants, generally too small to be seen with the naked eye, which typically grow in ponds, lakes, oceans, and wherever moisture is available, even if only intermittently (Figure 1.1). They can be found free-floating in water or attached to most surfaces, such as rocks. Microalgae are found from the coldest to the hottest climates, growing on snow and in desert rocks, some symbiotically with host plants or animals, others no longer able to photosynthesize, in some cases becoming parasites or even infectious (e.g. the malaria parasite!). This report considers only microalgae growing suspended in a water environment, not attached species. Over tens of thousands of microalgae species have been described, belonging to numerous families, classes, orders, and genera. Microalgae species probably outnumber higher plant species. The green algae, diatoms, and cyanobacteria are the most important in the present context. Green algae and diatoms are both eukaryotes (i.e., with a true nucleus), and the cyanobacteria are prokaryotes. Many more microalgae are probably not yet described or recognized as independent species, and even within a single species, there is enormous strain diversity in growth responses to environmental conditions such as light intensity, temperature and nutrients.

An extensive scientific literature exists for microalgae (also called phytoplankton; their study is “phycology”), due to their important roles in natural and human-impacted ecosystems. Microalgae account for about half the total global primary production (mostly in oceans), and they are the basis of most of the aquatic food chains supporting fisheries. However, their overabundance is often a symptom of inland or near-shore eutrophication, which can promote fish kills, dead zones, red tides, etc. Most research of microalgae has considered the ecological role of phytoplankton, including the effects of pollution, and much has been of a basic nature (physiology, metabolism, photosynthesis, genetics, etc.) (Falkowski and Raven, 2007). As in all fields of biology, advanced genetic and other recently developed molecular tools have been applied to the study of microalgae, from genomics to metabolomics and all the other “-omics.”

Applied R&D on microalgae cultivation has ranged over topics from food, feeds, and wastewater treatment to space exploration and biofuels production. Despite a much lower

level of government R&D investment in applied algae research than in the ecological and basic research, a small industry has developed for the production of microalgae for human nutritional supplements (~10,000 mt per year world-wide) and an even smaller one for aquaculture feeds. Thus, the microalgae industry is very small at present, less than 1% of the macroalgae (seaweed) industry, which produces >1 million tons annually, mostly for food ingredients. Most important in the present context, microalgae production costs are relatively high, production plant gate prices are estimated at ~\$10,000/mt dry weight for *Spirulina* – almost ten-fold higher than macroalgae production costs.

The biotechnology of microalgae production can be divided into the hardware (i.e., cultivation systems, ponds and/or PBRs with associated harvesting and processing equipment) and the wetware (i.e., the specific algae species and strains being cultivated). First, the wetware is discussed, including biomass composition and, most importantly, productivity.

2.2.2. COMPOSITION OF ALGAE BIOMASS AND OIL CONTENT

The three major components of algae biomass are, as for other living organisms, protein, carbohydrates and oils, with the latter being emphasized in this report. The first attempt to produce microalgae oil (lipids) production took place in Germany during and after WWII. It was observed that many species of green algae, when grown with nitrogen limitation, accumulated oil within their cells, reaching up to about 70% of dry weight (Harder and Von Witsch, 1942). Not all strains respond to N-limitation in a similar manner – some accumulated carbohydrates, rather than lipids. However, the rate of lipid biosynthesis by the algae cells was typically slow, taking many days, even weeks, to accumulate to a high concentration. Thus, although algae biomass with high oil content could be obtained, it could be produced only at relatively low productivity, no higher at any rate than N-sufficient cultures, which produced much more total biomass. This conclusion has been reached repeatedly over the past sixty years of research (e.g., Shiffrin and Chisholm, 1981) and remains a central issue in the algae biofuel field today.

The first attempt to mass culture microalgae came about 1950, with two small (about 100 m² each) closed bag-type closed photobioreactors (PBRs) set-up on the rooftop of a building at MIT (Burlew, 1953, see Figure 2.7). This project focused on the potential for growing *Chlorella* as a protein-rich human food. The argument was that *Chlorella* had higher protein content at 50% as crude protein (i.e., 6.25 x Total Kjeldahl Nitrogen content) than soybeans. This project initiated the development, in Japan, of the first commercial microalgae production of *Chlorella* for nutritional products using open, circular ponds, a process still used today in the Far East (Figure 2.8).

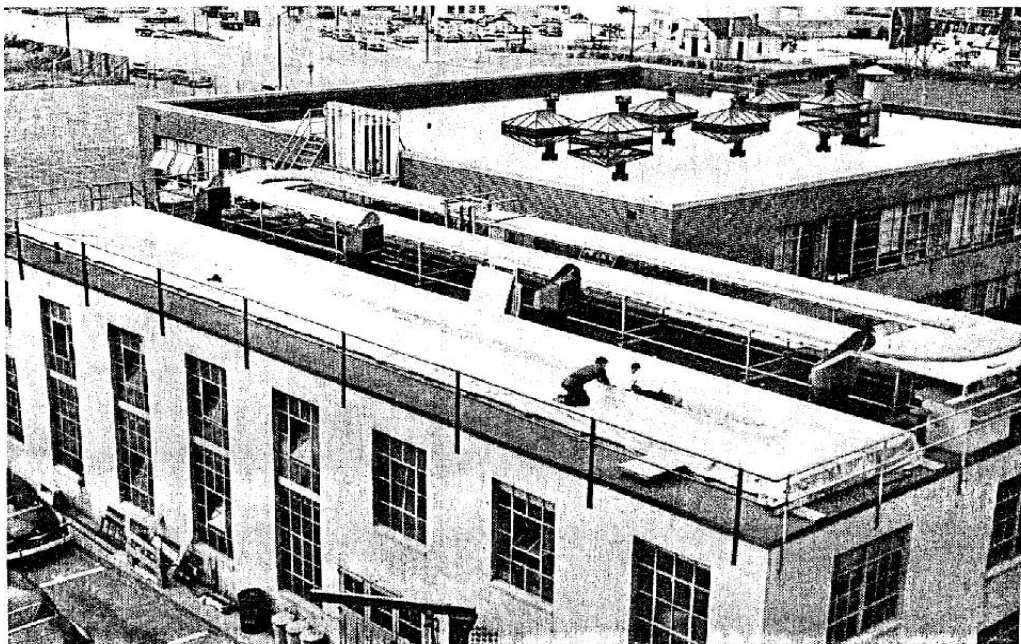

Figure 2.7: First Algae Mass Culture Experiments on a Rooftop at MIT (Burlew, 1953).

Algae production for oil (lipids) was revived when the US DOE initiated the Aquatic Species Program (ASP) in 1980. The ASP continued until 1996 with the goal of developing cost-effective algae biofuels production (Sheehan et al., 1998). The premise for this effort was that algae were uniquely able to produce high amounts of oils, and algae oil could become competitive with fossil fuels (based on work by Oswald and Golueke, 1960; Benemann et al., 1977; 1978; etc.). The alternative of producing carbohydrates for ethanol fermentations was not considered at the time, even though there was evidence that some algae species can accumulate large amounts of carbohydrates with high productivity following N limitation (Weissman and Benemann, 1981).

Only a few of the ASP projects dealt with the problem of algae lipid productivity. Benemann and Tillett (1987) observed that *Nannochloropsis*, a marine alga with high constitutive triglyceride (oil) content, could be stressed with N limitation in batch culture to increase lipid productivity when light intensity was also increased. Recently, Rodolfi et al. (2009) obtained data suggesting a possibly similar result with outdoor algae cultures. However, attaining high algae oil productivity (measured in g oil/m²-day) remains an unsolved problem and an active area of research. In this report, we assume that R&D breakthroughs in the field of algae photosynthesis and metabolism will achieve, to a moderate degree, the dual goal of high algae oil content and productivity.

2.2.3. ALGAE PRODUCTION SYSTEMS: PONDS AND PHOTOBIOREACTORS

Wastewater treatment ponds (also called “oxidation ponds”), already mentioned above (see Figure 2.5) are not suitable for algae production. Their unpredictable algae culture characteristics greatly reduce productivity and make harvesting difficult, with expensive chemical flocculants required. Such flocculants can interfere with conversion of the biomass to biofuels. Only the mechanically-mixed raceway ponds, so-called “high rate” ponds (Figure 2.1 and Figure 2.2) are suitable for large-scale, low-cost algae biomass production, whether for biofuels, wastewater treatment, or other low-cost applications. Circular ponds (Figure 2.9) used for *Chlorella* production in Japan and the Far East, do not scale above about 1,000 m² for individual ponds, making them impractical for large-scale production.

High rate ponds used in commercial algae production are typically operated at 20 to 40 cm (6 to 16 inches) liquid depth, mixed with paddlewheels and up to about 0.5 hectares in size. The productivity of such mixed ponds is almost an order of magnitude higher than unmixed ponds, as used in wastewater treatment or commercial *Dunaliella* production. The main factor of interest in operations is mixing. Channel flow velocity is typically 15 to 30 cm/sec. Higher velocities require too much energy, at least for biofuels applications. Another factor is the balance of O₂ and CO₂ concentration in the ponds, which involves an optimization of depth, mixing velocity, pH/alkalinity, pond size, and other parameters (Weissman et al., 1988). Maximum pond size is presently uncertain. Unknowns include the effect of wind fetch on headloss, waves, flow pattern, etc., but it appears that pond scales of several hectares should be feasible without significant loss of control over the key variables.

The main alternative photosynthetic production technology is enclosed photobioreactors (PBRs). The many PBRs designs developed use vessels such as tubes, plates, bags, domes, etc., and some have been scaled to considerable size (~1 ha). Tubular reactors are the dominant technology in commercial operations - both small diameter (~5 cm) rigid (see Figure 2.4) and larger diameter (>10 cm) tubular bag type reactors. Many other designs have been used in pilot scale production, including various types of flat plate reactors, hanging bag reactors, hemispherical dome reactors (used in one commercial plant in Hawaii, see Figure 2.8). PBRs are considered only briefly in this report due to their inherently high costs and limited scale-up potential: typically each PBR unit is only 10-100 m² in size. Thus, to replace the production of a single 4-ha high rate pond would require hundreds to thousands of such units, each with its own piping, valving, carbonation, and control system. Furthermore, PBRs are severely mass transfer limited (Weissman et al., 1988). However, PBRs will be useful for the initial stage of inoculum production for pond systems, but these would comprise only a very small area (<0.1%) of the total biofuels production system. Further stages in inoculum production would use covered ponds, but even these are limited in both their costs and operations. Thus in this

report, high rate ponds are emphasized in the biofuels production and wastewater treatment system designs.



Figure 2.8 and Figure 2.9: Dome reactors and circular ponds.

Figure 2.8: Left, *Haematococcus pluvialis* production, dome photobioreactors (Fuji Co., Hawaii; domes are ~1 meter in diameter)..

Figure 2.9: Right, *Chlorella* production pond of ~500 m² (Chlorella Industries, Japan)

2.3 ALGAE BIOMASS PRODUCTIVITY

2.3.1. MAXIMUM THEORETICAL SOLAR CONVERSION EFFICIENCY

For all biofuel production processes, productivity is of paramount importance. However, it is a myth that microalgae are the most productive of plants. This myth arose perhaps because of confusion between algae's fast growth rates (doubling of cell numbers and mass can occur every few hours under optimal conditions) and productivity (the amount of biomass produced each day, or year, per unit area or per input sunlight). Maximal photon conversion efficiency is observed when light is limiting and maximum productivity at well below maximal growth rates. Indeed, there is no apparent direct correlation between high maximal growth rate and high productivity or photon conversion efficiency (Huesemann et al., 2009).

In all algae and higher plants, the enormously complex process of oxygenic photosynthesis involves the same fundamental processes of water splitting and CO₂ fixation. Minor variations to the fundamental process exist, in particular what type of pigments harvest photons and feed the captured energy ("excitons") to the photosynthetic reaction centers. At these centers, the "dark reactions" convert the excitons into chemical energy which is then further transformed

into ATP and reductant in the form of NADPH. These compounds are used in metabolism, in particular in the CO₂ fixation pathway, in which CO₂ is reduced to carbohydrates.

Microalgae have long served as convenient laboratory stand-ins for higher plants, starting with the initial studies of photosynthesis with *Chlorella*, conducted a century ago by Prof. Otto Warburg, who had earlier won a Nobel Prize for elucidating the mechanism of respiration. At that time, Warburg and co-workers concluded that only four photons were required to produce one molecule of O₂ and fix one of CO₂, something that thermodynamically might barely be possible. However, Warburg was wrong: 8 photons are required to fix one molecule of CO₂. It took several decades and many researchers to correct this and establish the current theory of photosynthesis, the so-called Z-scheme. The Z-scheme requires two photons to act in series to transfer one electron from water to CO₂, or a total of eight photons per CO₂. A few additional photons are needed for the biosynthesis of proteins, lipids, nucleic acids, other cell components and for the maintenance of cellular function (respiration or “maintenance energy”). The result is a maximum theoretical efficiency of total solar energy conversion into biomass of about 10% (9 – 11%). The uncertainty is due to small differences in details regarding light capture and the precision of some measurements. However, such efficiencies are only observed at low light intensity in the laboratory. At high light intensity, the so-called light saturation and photo-inhibition effects take their toll, see below.

What is observed in outdoor cultures is quite different from what is predicted by theory and observed in the laboratory at low light intensity. The best light energy conversions into biomass observed with either actual or simulated full-sunlight intensities is only 1% – 3%, compared to the just quoted maximum theoretical of about 10%. This great loss in efficiency (i.e., productivity) is a central problem in photosynthetic biomass production, but it is particularly a problem of microalgae production, where the light saturation effect is a major factor in such low efficiencies, as discussed next.

2.3.2. THE PRACTICAL LIMITS TO ALGAE SOLAR CONVERSION EFFICIENCY

The major factor limiting solar conversion efficiency in photosynthesis, both in microalgae and to a lesser extent in higher plants, is the so-called light saturation effect. When measuring photosynthesis rate (e.g., CO₂ fixation or O₂ evolution) as a function of light intensity, a linear increase is observed at low intensities, but the rate levels off when light intensities are only about one tenth that of full sunlight. This plateauing is due to the bottleneck of the rate at which the reaction centers of photosynthesis can transform light into chemical energy.

The photosynthetic apparatus collects photons with an array of chlorophyll and other light harvesting pigment molecules, which are arranged in so-called “antennae.” The antennae pigments transfer the captured photon energy (excitations) to the reaction centers. A typical

light harvesting antenna in green algae consists of 200-300 chlorophyll molecules, which at full sunlight intensity capture about one photon every 0.5 ms (millisecond). However, the reaction centers can process only one exciton about every 5 ms. The excess photons, 90%, are still absorbed but cannot be used. They are wasted as heat or fluorescence. Indeed, these extra photons can even damage the photosynthetic apparatus, resulting in a decrease in photosynthesis at full sunlight intensities (“photo-inhibition”).

One common approach to decreasing light-saturation is sunlight dilution in which the objective is to expose the individual cells in a culture to an even, low intensity of light. Research on sunlight dilution has been carried out for over 50 years, and the first, and still popular, method is to move the cells in and out of the high light zone at a high frequency. Ideally, they would be exposed to high light for only the 0.5 ms required to capture one photon per reaction center. They would then be kept in the dark for the 5 ms required for the dark reactions to complete. Although somewhat longer time constants can still achieve some increase in photosynthetic efficiency, these millisecond intervals are too short for practical applications. If the light-dark cycle is achieved by mixing the cells to below the surface to be shaded by other cells, then this rapid mixing implies high energy inputs and parasitic losses.

Another popular, but also impractical, method is to use devices such as optical fibers, prisms, light guides, etc. to dilute the light from the surface to deeper into the culture. Any significant algae biomass production would require a multitude of such devices, and the cost and complexity would make scale-up prohibitive.

The simplest approach to sunlight dilution is to orient photobioreactors vertically, instead of horizontally, to catch the sunlight over a larger surface area. However, this approach is not practical either: a 50% increase in productivity can be estimated for a vertical PBR array consisting of 1-m tall panel PBRs spaced one third of a meter apart. This configuration, however, requires 3 m² of transparent panel per m² of land area, which means that per unit area of PBR, the productivity is actually decreases to half (i.e., 150%/3) compared to that of similar PBRs laid horizontally on the ground. Because PBRs are much more expensive per unit area than land, it is more practical to use horizontal PBRs. A somewhat higher productivity enhancement might be achievable with closer spacing of vertical PBRs, but with even greater costs.

Even horizontal PBRs are too expensive by an order of magnitude or more for biofuels applications. In conclusion, the solution to the problem of how to overcome light saturation and photo-inhibition cannot come from such engineering approaches.

2.3.3. GENETIC APPROACHES TO INCREASING ALGAE SOLAR CONVERSION EFFICIENCY

The light saturation effect is a major limiting factor in the photosynthetic efficiency of higher plant crops, but it is not as severe as it is for microalgae cultures. One reason is the three-dimensional architecture of plants. Their leaves are not generally horizontal, and their internal structures act as light guides, helping to dilute the light. A more fundamental factor is that in the canopy, the leaves at the top which are exposed to full sunshine often have smaller antennae (i.e., fewer chlorophyll molecules per reaction center) than the leaves in the shade further down the canopy.

One approach to increasing photosynthetic efficiency in algae would be to also use algae strains with low antenna pigment content. These would presumably exhibit less light saturation effect since less antenna pigment would allow more light to pass into the culture, thereby diluting the light (Kok et al., 1973). However, no such algae have been identified. Algae do not exhibit small antenna sizes except under conditions of severe stress, when photosynthesis is already strongly inhibited (Neidhardt et al., 1998). The reason for universally large antenna is that, in nature, algae are frequently in low-light environments (e.g., deep water, shade, low sun angle), and large light harvesting pigment arrays should provide an evolutionary advantage to algae that have them. The calculus of competition suggests that it is more advantageous to waste photons when they are in excess than to be lacking when they are scarce. This analysis also suggests that if antenna size were decreased through genetic engineering (e.g., Benemann, 1990), such strains would not be able to compete for long in an algae mass cultivation system, where competition for light is as fierce as it is in nature. Thus, despite their potential for high productivity, any modified algae strains would be at a significant disadvantage. Without pond management, they would be quickly replaced by invading weed algae or genetic revertants that would have a competitive advantage in the dense algal cultures required for mass cultivation.

The frequency and rate of such invasions and how to minimize these will need to be determined from future pond studies. However, it is likely that mass cultivation of small antenna algae will be possible with the use of large inoculations, nutrient management, culture re-starts, and control of other factors that favor the desired strain. Techniques analogous to these are used to maintain yeast cultures in fuel ethanol fermentations, for example.

Based on the initial suggestions (Benemann, 1990; Benemann and Oswald, 1996), research has advanced over the past two decades on antenna size reduction, with initial work carried out in Japan by Mitsubishi Heavy Industries using mutant cyanobacteria and green algae having small antenna sizes (Nakajima et al., 1997; 1999; 2000) and at U.C. Berkeley under a DOE algae hydrogen program (Neidhardt et al., 1998; Benemann, 2000; Eroglu and Melis, 2010). Several other laboratories have also worked on the topic (e.g., Schenk et al., 2008; Huesemann et al.,

2009), and research is ongoing. However, a practical demonstration of increased and sustained solar conversion efficiencies (and productivity) by such strains remains to be demonstrated. The inherent limitations of the mutagenesis approach make it likely that only a genetic engineering approach will succeed in crafting robust algae strains that have the desired properties of high sunlight efficiency. Although this approach is likely the main one that will lead to future high productivities by algal mass cultures, the present report is not based on such small antenna size cultures.

2.3.4 THEORETICAL AND PRACTICAL LIMITS OF ALGAE BIOMASS PRODUCTIVITY

At 1 – 3% solar energy conversion efficiency, current algae production methods have higher conversion efficiency than most crop plants. However, achieving even higher algae productivities is a necessary precursor to a viable algae biofuel industry due to the high capital and operating costs of algae production. A major issue is what solar energy conversion efficiencies can be achieved and how that translates into oil productivities (see Weyer et al., 2010 and Cooney et al., 2010 for recent reviews).

A maximum algae oil productivity can be estimated from fundamentals. As stated above, the theoretical limit of photosynthesis has been estimated by most experts to be about 10% (9 – 11%) conversion of total solar photon energy into biomass energy. The maximum total solar energy received in the continental US is about 7,500 MJ/m²-yr (e.g., Yuma, Arizona), so at 10% efficiency, 750 MJ/m²-yr could be captured in biomass. If algae biomass were to contain 40% oil (triglycerides, LHV of 37.5 MJ/kg) and 60% carbohydrates and protein (combined LHV 18 MJ/kg)¹, the total biomass LHV is 25.8 MJ/kg. Using the above energy information, the theoretical biomass yield is about 290 mt/ha-yr (about 80 g/m²-day average annual). At 40% oil content, 116 mt of oil would be produced or 126,000 L/ha-yr or 13,500 gallons of oil/acre-yr, at a specific gravity of 0.92. In addition to this direct fuel potential, the residual biomass might be converted to fuel by some unspecified process (neglected here).

However, the above calculation ignores unavoidable losses: inactive photon absorption (~10%), reflection (~10%), and respiration (likely ~20%), all of which reduce the theoretical productivity

¹ Assuming 50% carbohydrates (16 MJ/kg) and 50% remaining biomass, mainly protein and nucleic acids (combined: 23 MJ/kg). However, the heat of combustion of the N content of the residual biomass (~10% N, dry weight basis) is not supplied by solar energy, a correction that is generally ignored but reduces the overall energy content of the biomass to 20 MJ/kg.

to 8,750 gal/ac-yr — still an astounding rate. Considering the additional losses due to light saturation and photo-inhibition (assume a combined 75%), solar conversion efficiency is decreased to 1.62%, which gives an oil production potential “only” about 2,200 gal/ac-yr (20,600 L/ha-yr), or as biomass, 13 g/m²-day for this oil content level. Note that if the light saturation/photo-inhibition effect could be reduced by half from 75% to a 37.5% loss, the annual productivity would increase to 5,500 gal/ac-yr. This oil productivity would likely be the maximum achievable with successful long-term R&D and good climatic conditions. These productivities assume essentially no other loss factors or limitations, such as losses due to grazing and other contamination, unfavorable temperatures, lower sunlight locations, less than optimal nutrient supply (in particular CO₂), or higher than expected respirations, etc.

A more conventional biomass with a 20% oil content and a heat of combustion of only 22 MJ/kg could have a maximum average annual productivity of 15 g/m²-day (75% light saturation and photo-inhibition losses). This productivity projection of 15 g/m²-d, for a normal-level oil content biomass, matches the best currently documented outdoor pond mass cultures in favorable locations, although from relatively small scales and/or limited operations (Darzin et al., 2010; Ben Amotz, 2009).

2.3.5. OIL CONTENT AND PRODUCTIVITY IN ALGAE MASS CULTURES

Algae oil production is the focus of almost all current interests in algae biofuels. However, algae do not produce oil in copious quantities, and when they do, it is generally only under duress (i.e., nutrient limitation) and at low rates. The process of domesticating algae is just beginning.

The problem of algae oil productivity is that, with a few exceptions (e.g., *Nannochloropsis*), algae do not produce and store large amounts of triglycerides while actively growing. Those species that do accumulate oil do so only after growth is inhibited for some reason (such as nutrient limitation). Then they start accumulating triglycerides as an energy reserve. Unfortunately, growth inhibition is a result of the shutting down of photosynthesis, at which point it cannot be expected that oil production will take place at a high rate. Thus, the emphasis in prior research on finding a “lipid [biosynthesis] trigger” that initiates oil production in response to, for example, nitrogen limitation, is only part of the picture. The metabolic signals that up-regulate lipid biosynthesis only come after photosynthesis is already greatly reduced due to lack of a limiting nutrient. Indeed, in many cases triglycerides biosynthesis is not greatly induced.

The accumulation of lipid bodies (detected by Nile red staining) suggests that, once formed, lipids are stored in the cell. Further, and also encouraging, these lipids are generally

triglycerides and more reduced (saturated) than those found in actively growing cells, both key issues in converting algae oils into fuels.

2.3.6. SUPPLY OF CO₂ AND OTHER NUTRIENTS

Algae biofuel production requires an initial step of learning how to grow algae of a chosen species at large-scale, at low cost, consistently, and at high productivity. The objective is to grow algae with light as the only limiting nutrient, thus assuring that all light will be used as efficiently as possible.

Other than light, carbon is the most important nutrient, making up about half the dry weight of algae. Generally, it should be supplied as CO₂, but storage of dissolved CO₂ in the growth medium is limited, being dependent on alkalinity. If CO₂ is provided in excess, it will be released back to the atmosphere from the pond surface. Since pumping of CO₂ to the cultivation systems will typically represent a parasitic energy loss, efficient use of CO₂ is desired.

Thus, CO₂ must be added in frequently and in controlled amounts. From an engineering perspective, CO₂ supply is perhaps the key issue in the design of algae production systems. As an example, we consider the use of seawater in the following: Seawater with an alkalinity of 2.3 meq/L allows storage of about 0.8 mmole/L of inorganic C between pH 7.3 and 8.8. A 30-cm deep pond with a maximal productivity of 5 g/m²-hr and 50% C as algae (ash free dry weight, afdw) would require 2.5 g of C/m²-hr compared with the 2.9 g of C available /m² in the pond (and some would outgas). Thus, the medium would need to be re-carbonated every hour, with the pH lowered to 7.3 to assure enough CO₂ is available for maximum productivity. This time interval sets the spacing of carbonation stations along the circuit of the ponds.

Other nutrients should also be supplied *ad libitum*. For algae biofuel feedstock production, nitrate is a poor form of nitrogen because it is too expensive, both in terms of cost and the metabolic energy required to reduce it to the level of ammonia (productivity would decrease by somewhat over 5% on this account). Strains of algae that can use ammonia or urea will be required for optimal productivity. Ammonia should be added to the culture medium at the time that CO₂ is injection. The lower pH caused by CO₂ will decrease ammonia volatilization. A host of other nutrients (P, K, Fe, Mn, Mg, etc.) are also required. Since algae have an extraordinarily high nutrient content (5% – 12% N and 0.3% – 0.5% P) compared to most crops, recycling the residual biomass nutrients after oil extraction is a key issue.

Anaerobic digestion of the residual biomass, with the digester effluent discharged into the algae ponds would allow recycling of the nutrients, including residual C. The timing of the recycling, would be coordinated with other process operations for maximum overall effectiveness, such as control of grazers, contaminants, and oxygen levels (digester effluents

have a high biological oxygen demand). One major unknown is the efficiency of nutrient recycling, but fundamentally it should be high (~90%). Efficient recycling would minimize the need to purchase fertilizers. However, this needs to be demonstrated in practice. In this report, use of waste nutrients is emphasized, but this is not a fundamental requirement.

2.3.7. TEMPERATURE LIMITATION ON PRODUCTIVITY

The major environmental factor limiting algae biofuels production, at least in the US, is likely temperature. Algae productivity is maximal in a rather narrow range compared to what is found in temperate climates. The optimal temperature regimes for algae strains currently used in mass cultures show steep productivity declines below about 20°C and, on the high end, above about 35°C.

Unlike field crops where plant biomass accumulates until harvest, algae must be harvested daily. At some low algae productivity, the gains (in terms of revenue or energy production) fall below the costs. Under these circumstances, algae production systems are best shutdown until conditions improve. The breakpoint productivity for minimal algae fuel production would likely be somewhat above 5 g/m²-day, at which point the inputs (in particular energy) required to operate the process would exceed outputs.

Regions with average temperatures of 15°C have been considered unsuitable for algae mass cultivation (Harmelen and Oonk, 2006), but that cut-off is simplistic. Diel temperature regimes are more significant, and hour-by-hour pond temperatures can be accurately predicted for any location with models that use local historical weather data (e.g., Benemann and Tillett, 1987). From these models, it can be determined that in most desert regions of the US, the limiting factor in algae growth rate would likely be low night-time temperatures. These impact photosynthesis rates by then requiring a long time to warm up during the day. Some literature data suggests that this will reduce photosynthesis rates even after the temperatures in the ponds increase (Vonshak et al., 2001).

Ways to ameliorate this problem have been considered previously, such as covering ponds with foam or cheap plastics or increasing pond depth or the size of the settling ponds to allow for greater night-time storage, etc. However, none of these methods appeared to be sufficiently low cost for biofuels production. Although, perhaps a combination of approaches could be practical in some cases.

Indeed, normal pond operations could moderate diel temperature changes. For example, during summer, up to half of the pond culture would be transferred to algae settling ponds at the end of the day, when temperature is highest. Before morning, the settling pond supernatant would be recycled back to the growth pond. Heat loss from the settling ponds is

about one-tenth of that in the growth ponds (they are ten times deeper). Thus, in the morning the ponds would rapidly regain temperature, in time for photosynthesis to re-start.

Another way to overcome temperature limitations is to find algae strains that maintain high productivity at lower temperatures, and over a greater temperature range. Strains that adapt more quickly to diel temperature regimes would also be beneficial. Some algae can grow rapidly under both low and high temperatures in natural environments. Such temperature resilience has not been a major focus of past research or strain collection, leaving open the possibility that particularly hearty strains will be discovered or developed.

2.3.8. SELECTION FOR IMPROVED MICROALGAE STRAINS

Control of culture biology is the most complex and difficult issue in mass algae production. The topic includes invading algae species that could displace desired strains; algae grazing zooplankton such as rotifers; bacteria and fungi that could infect the algae, and even viruses. Control of all of these factors or developing algae with increased resistance is essential for sustained high productivity. However, whether sufficient control over the biotic environment is possible is, at present, a major unanswered question in algae biofuels production (Gershwin and Belay, 2007). The current experience is only somewhat encouraging: algae have been cultivated as monocultures in a sustained fashion in only a few instances.

Commercial operations have produced monocultures of *Spirulina* and *Dunaliella*, with essentially little or no inoculum production being required, but only because the growth media compositions are selective (alkaline or saline). Such extreme environments do not allow high productivity and suggest that “extremophiles” are not a good target for future research.

Chlorella and *Haematococcus* are cultivated commercially without a selective media, but they require extensive inoculum production and frequent culture restarts, which makes them poor guides for algae biofuels production. *Nannochloropsis* and *Cyclotella* (a diatom) have been stably mass cultured at a smaller scale for long periods and appear to have good productivity. Although subject to invasion by rotifers and other predators, cultures of these algae appear manageable. Few other species have been produced in the outdoor environment at any substantial scale or duration.

The discovery or development of algae strains capable of high oil productivity in various locations and conditions is a fundamental need. The US DOE Aquatic Species Program (ASP), as one of its first activities, went through a major algae strain isolation, screening, and testing effort. Algae were isolated from a wide variety of natural environments, and pure cultures were established in two types of growth media (corresponding to the two saline ground waters types expected for a large production system in the US Southwest). The responses of these

algae to pH, temperature, and light were studied and their lipid composition investigated (see Chapter 3). A great deal of work has again been initiated along these lines, but now with more advanced genetic engineering capabilities, more precise strain development may become possible.

2.3.9. GENETICALLY MODIFIED ALGAE- GMA

Perhaps no subject, outside nuclear energy, has raised so much hope and engendered as much fear, as the development of molecular genetics, giving rise to genetically modified organisms (GMOs). To achieve the goal of high microalgae productivity with a high content of oil, molecular genetics will be a necessary tool. Without such tools, the process of producing the needed superior strains of algae using traditional screening of mutants (spontaneous or induced) would be difficult. Such strain development was more easily achieved in higher plants due to sexual recombination. Even for the algae with a sexual lifecycle (e.g., *Chlamydomonas*), search and selection for mutations alone would not likely achieve the goals required for biofuels production in a reasonable time. At best, such algae would be useful as model systems for the strains to be used in mass cultivation.

The major issues with GMAs are less technical than social and political. A significant part of the population is suspicious or in opposition to GMOs in general. The situation will no doubt be similar for GMAs once they become more newsworthy. Unlike GMO crops, which have had major support by farmers, governments, and large companies (e.g., Monsanto), GMAs are unlikely to have such strong advocates. It thus behooves the incipient microalgae industry to move carefully and prepare the political and social ground for any use of such GMAs in commercial or large experimental settings. At present in the US, there is some question whether applicable laws and regulations constrain the use of GMAs for biofuels production, and there is the possibility that some companies may go ahead and use of GMAs in open ponds under current regulations (or their absence). In terms of strain containment, closed photobioreactors are only cosmetically different from ponds, as culture leakage is unavoidable in such systems. The ecological effects of GMA releases cannot be evaluated at this time, but developing GMAs that can dominate in the harsh, variable environment of outdoor pond production will be challenging.

Ecological theory suggests that existing wild organisms are best adapted for survival in natural environments and that organisms engineered for traits desired by humans (e.g., high lipid productivity) will only survive in controlled production environments through careful management of the process variables. Even so, modified genes may be transferred to wild populations, and specific studies are needed to evaluate the ecological risk of such transfers. However, genetic engineering does not have to involve insertion of foreign genes (e.g.

transgenic GMO). Only slight modification of existing regulatory genes may be sufficient to improve algae strains. GMAs also differ quantitatively, even qualitatively, from macro-organisms, where introduction of foreign organisms into novel ecosystems can be a concern. To promote a fair assessment of GMA risks and opportunities, the incipient algae biofuels industry would be well advised to proactively have these issues addressed by competent authorities, through completely independent assessments, prior to any use of GMAs. This would provide assurance to public, and reduce risks to investors and corporations.

There is already a large literature on microalgae genetics, and the underlying knowledge about their molecular biology, from genomics to metabolomics, etc., is expanding rapidly. The main focus was on *Chlamydomonas* (which has a sexual recombination system), but these tools are now developed for diatoms and *Nannochloropsis*, using ballistics. For cyanobacteria, the tools are already well advanced. Thus, it is already possible to develop algae strains that are improved, from organisms that have small light harvesting antennae to those that have an improved oil production. One area of active investigation is the genetic development of algae that can excrete oils, on essentially a continuous basis, thus avoiding the need to produce much biomass (e.g., Liu et al., 2010).

CHAPTER 3 ALGAE BIOFUELS – ENGINEERING CONSIDERATIONS

3.1 ALGAE BIOFUELS: PRODUCTION A BRIEF HISTORY

3.1.1. INITIAL WORK AT THE UNIVERSITY OF CALIFORNIA, BERKELEY

The initial research on mass cultivation of microalgae that began in the early 1950s mentioned biofuels in only in passing (Burlew, 1953). Actual research on this concept was first carried out at UC Berkeley by Oswald and colleagues, who first studied methane gas production by anaerobic digestion (fermentation) of microalgae biomass produced during wastewater treatment (Golueke, Oswald, and Gotaas, 1957). These early experiments were followed by a laboratory demonstration that additional biomass could be grown on the effluent from the anaerobic digesters (Oswald and Golueke, 1959). An initial techno-economic analysis was developed of a conceptual process that used wastewaters for make-up water and nutrients and recycled the nutrients and water (Figure 3.1). They concluded that at that time algae power was competitive with nuclear power (Oswald and Golueke, 1960).

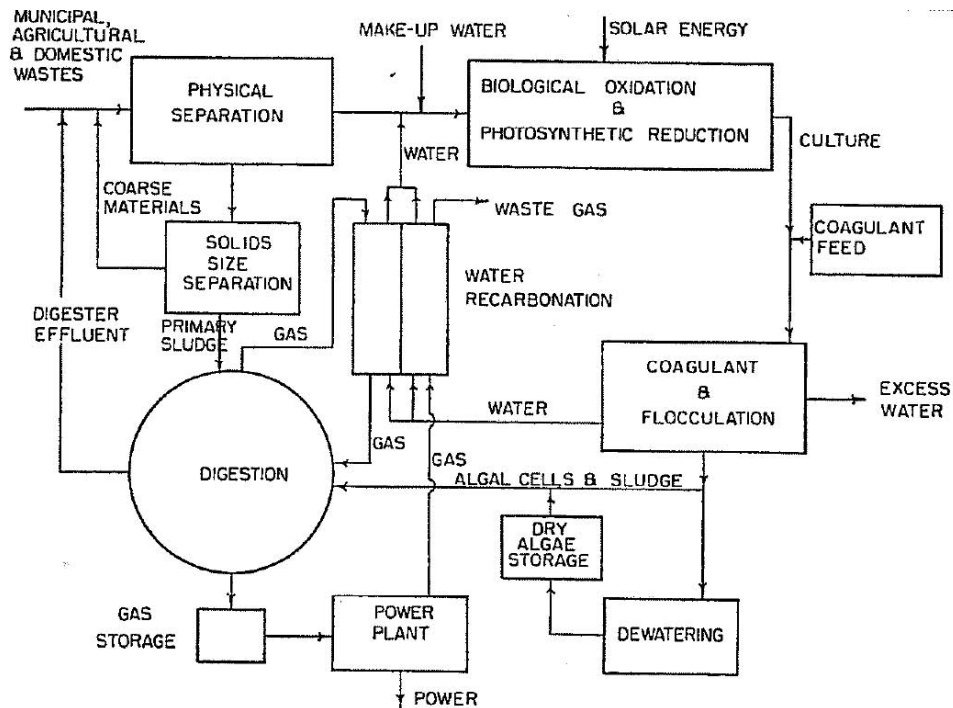

Figure 3.1: Algae-Methane-Electricity Process Schematic (Oswald and Golueke, 1960).

In this process, algae were harvested by chemical flocculation followed by biomass slurry thickening. Sludge from the settling pond at the treatment plant inlet was mixed with the algae biomass and fed to a digester, producing biogas. The present report essentially uses the same approach, with the major modifications being a lower cost harvesting process and the production of oil rather than methane as the main energy output in some of the cases developed in Chapter 5.

This concept attracted little interest or support at the time. However, after the energy crisis of 1973, all alternative sources of energy underwent considerable scrutiny, and research on anaerobic digestion of algae biomass for methane production was restarted (Uziel, 1975). Research into algae biofuel production using wastewater in conjunction with methane production was revived at UC Berkeley with support from the US DOE (reviewed in Benemann et al., 1980; see also Sheehan et al., 1998). The major emphasis of these studies was to develop a low cost harvesting process for wastewater grown algae grown in high rate (raceway) ponds (Chapter 2).

At the UC Berkeley Richmond Field Station, an existing quarter-hectare pond was converted to two 1,000-m² high rate ponds with paddle wheel mixing (Figure 3.2). (This was the largest-scale application of such a mixing device at the time, earlier used in Germany for small ponds).

The initial concept was to select for filamentous cyanobacteria by partially recycling harvested biomass to the ponds. Harvesting was accomplished by micro-strainers (rotating screens with backwash). Although theoretically feasible (Weissman and Benemann, 1977), the field results with small ponds quickly demonstrated that a green colonial alga, *Micractinium* sp., took over, seemingly because it was also captured by the micro-strainers and recycled. However, it soon became apparent that this species dominated the high rate ponds regardless of recycling. Further, it could be harvested in simple settling tanks because of its tendency to aggregate as larger colonies, a process termed “bioflocculation.” The two 1,000-m² ponds were used to demonstrate this process at the pilot scale for over a year, with relatively high productivities, but the research was not carried forward at that time. However, this process provided the basis for the prior (Benemann et al., 1977, 1978, 1982a,b; Benemann and Oswald, 1996) techno-economic engineering studies, and also the present one.



Figure 3.2: High Rate Ponds at the “Sanitary Engineering Research Laboratory” (SERL), Univ. of California, Berkeley, ca. 1994.

(The two HRP are 1000 m² in size, the circular pond at the top is a facultative pond.)

Note that the now “standard model” for microalgae oil production (Benemann et al., 1982a; Benemann and Oswald, 1996) modifies the initial Oswald and Golueke (1960) scheme by replacing the chemical coagulant-flocculation-settling harvesting step with a “bioflocculation” step (spontaneous flocculation-settling) and extracts algae oil by means of cell breakage and three phase centrifugation (no drying step), among other changes.

3.1.2. THE AQUATIC SPECIES PROGRAM (ASP)

In 1980, the DOE Solar Energy Research Institute (SERI, now NREL, National Renewable Energy Laboratory) initiated the “Aquatic Species Program” (ASP) to conduct research on microalgae oil production. Alternative liquid transportation biofuels were viewed as possible long-term sustainable domestic sources of such fuels. Ethanol from microalgae was not considered at the time of initiation of the ASP, as it was thought that ethanol from ligno-cellulosic biomass was close to becoming a commercial reality, and that thus there was little need for another option.

Initially, the ASP focused on a closed photobioreactor (PBR) design and an algae oil production process (Raymond, 1981) that claimed productivities of over 125 mt dry biomass/ha-yr, with a

high oil content. However, an independent analysis, carried out on behalf of DOE, found no basis for such claims and an engineering economic cost study demonstrated that this design, and PBRs, in general, had no merit for biofuels production (Benemann et al., 1982b). Benemann et al., (1982a) carried out a more detailed techno-economic analysis of an open raceway pond process for algae oil production, based on an assumed algae biomass productivity of 82 mt/ha-yr (30 t/ac-yr) and oil content of 40% (~2.4 barrels²/mt) and projected competitive costs with the high oil prices of the time. This led to the ASP adopting the open high rate ponds and harvesting by bioflocculation-settling as their process model (Figure 3.3). Achieving the projected productivities and oil content became a major goal of the ASP.



Figure 3.3: Artist Conception of an Algae-Oil production Process.

(SERI, ca. 1985, based on Benemann et al., 1982b. Square ponds in the foreground are for algae settling).

The ASP supported many research projects (summarized by Sheehan et al., 1998) which included both research at SERI/NREL and many cooperating universities, research institutes and small companies, which need not be reviewed here. Suffice it to state that the research

² US petroleum barrels of 42 US gallons (159 L) are used throughout this report.

covered the entire field of algae biofuel production, in particular isolation of algae strains, and outdoor pond studies in California, Hawaii and New Mexico. The ASP also examined the availability of resources for sustainable algae biofuel production in the US (Vignon et al., 1982, Maxwell et al., 1985, Neenan et al., 1986, and Feinberg and Karpuk, 1990).

A detailed techno-economic study was carried out by Weissman and Goebel (1987), in a competition with a proposed PBR process and was then used as the basis for the Roswell Test Facility in New Mexico. This became the major achievement of the ASP, where Weissman and colleagues (Weissman et al., 1988, 1989, 1990) built and operated two 1,000-m² ponds, one lined with plastic and one with a dirt floor (Figure 3.4). The greatest value of this work was to demonstrate the feasibility of growing algae on a groundwater resource at this location, with a reasonable productivity. Perhaps even more important, those studies demonstrated the ability to not only transfer, but also retain, the injected CO₂ in the ponds, at least long enough for the algae to use. The work at Roswell and the engineering study of Weissman and Goebel (1987) is a major basis for the entire field of algae biofuels production and of the processes analyzed in the present study.



Figure 3.4: The Roswell Algae Test Facility, New Mexico (Weissman et al., 1988).

With the waning of the energy crisis, the ASP budget was cut to such a low level that even with DOE-NETL (National Energy Technology Laboratory, Office of Fossil Fuels) co-funding, it could not remain as a viable program. The ASP was finally closed in 1996.

At that point, DOE NETL funded an updated algae biofuels techno-economic analysis for oil production and greenhouse gas abatement that specifically considered coal-fired power plants as the CO₂ source (Benemann and Oswald, 1996). That study reviewed, updated and extended the prior studies, and suggested an oil extraction process that did not require drying the

harvested algae biomass (as assumed in the prior study), being based on cell homogenization (breakage) followed by emulsification with recycled oil and centrifugation.

3.1.3. RECENT DEVELOPMENTS IN ALGAE BIOFUELS

During the 1990s, the Japanese government supported a major program on algae for CO₂ capture and greenhouse gas abatement, with a budget of >\$250 million dollars (>10X the \$25 million ASP budget). The Japanese program focused almost exclusively on closed PBRs and mostly on so-called optical fiber bioreactors, designs that collect sunlight using large concentrating mirrors and transmit the sunlight via optical fibers into closed vessels to illuminate the algae cultures throughout its depth. Although such PBRs achieved, in laboratory experiments, higher productivity than horizontal reactors illuminated on their surface, they were clearly much too expensive, something not acknowledged until the ten year effort had run its course, and then only in a single sentence in an unpublished final report.

An “International Network for Biofixation of CO₂ and Greenhouse Gas Abatement with Microalgae” was formed in 2002 and continued until 2007, as part of the IEA Greenhouse Gas R&D Programme, with support from DOE NETL and the Italian oil company Eni. A “Technology R&D Roadmap” was developed for this initiative (Benemann, 2003) and a resource assessment of algae biofuels was performed with emphasis on synergies with municipal wastewater treatment (Harmelen and Oonk. 2006). However, as commercial interest in algae biofuels increased, concerns about safeguarding intellectual property became an impediment to this cooperative effort, and the Network suspended activities by 2008.

Over the past five years there has been a resurgence of interest in microalgae biofuel production, in particular algae oil production. Much of this resurgence was due, most importantly, to the increasingly desperate search for an inexpensive, secure and plentiful replacement for oil, as oil prices climbed to over \$100/barrel, and by fears of global warming and the need to control CO₂ emissions. Public relations feats that included airlines flying with algae fuels (Continental did a test flight in January, 2009) and experimental cars fueled with algae oil have contributed to the interest and hyperbole in this field. Announcements of large corporate investments in algae biofuel technologies, from tens of millions (BP, Shell, Eni) to hundreds of millions (ExxonMobil), have added to the fervor and attracted added media coverage. Two US trade organizations (the ABO, Algal Biomass Organization, and the NAA, National Algae Association) and an European one (EABA, European Algae Biomass Association) are active in the field. They and many other organizations hold conferences such that, in recent years, it seems there is hardly a week without an algae summit or conference taking place someplace in the world.

The Department of Energy has also re-entered the field of algae biotechnology in the past two years with DOE EERE (Office of Energy Efficiency and Renewable Energy) recently issuing a “Technology Roadmap” and funding two pilot projects and one demonstration project with \$100 million in grants (plus another \$50 million plus in loan guarantees from the USDA given to the demonstration project). Earlier this year, the DOE funded a \$44 million three-year program by a ~20 member consortium (the National Alliance for Advanced Biofuels and Bioproducts, NAABB). Smaller, consortia, energy centers, and other initiatives by various offices of DOE (such as a \$70 million investment in a project in Arizona by NETL-DOE) have added to this recent funding spurt. The Department of Defense, DARPA, funded two algae projects (~\$70 million) to develop technology capable of producing algae oil for less than \$3/gallon by 2012. The USDA has provided a \$50 million loan guarantee to one project. Overall the US Federal Government is on track to investing over half a billion dollars into this field, and total funding in the US and abroad will likely exceed \$2 billion. Any lack of progress will not be due to lack of funding.

Unfortunately, much of the current interest in algae oil production is based on a lack of understanding of the science underpinning this technology, and on a misreading, or lack of reading, of the prior technical reports. For one example only, although some algae strains can accumulate large amounts of oil as triglycerides under certain conditions, up to and even exceeding 50% of their dry weight, they do so only at low rates and productivity. This would not allow practical applications, even assuming that it were possible to grow such algae on large scales at low costs. Thus, development of this technology is not likely to be a sprint to the finish line, but, rather, a long and difficult march, with high risks and uncertain outcomes.

3.2. CULTIVATION SYSTEMS

3.2.1 OPEN PONDS – DESIGN AND OPERATIONS LIMITATIONS

Open ponds for algae production are relatively (compared to PBRs) simple in construction and operation. As already discussed, they fall into three configuration categories: unmixed, circular, and raceway. Unmixed ponds are not controllable, cannot be supplied with CO₂ efficiently, and are of low productivity. (However, none of these constraints have detracted from the success of the beta-carotene plants in Australia (Figure 2.3), or similar ponds in Mexico for Spirulina production, where land availability made productivity not a major issue.) Circular ponds (Figure 2.9), the first design used in commercial algae production, do not scale above ~1,000 m², as the center pivot mixer becomes unwieldy at this size. The mechanically-mixed shallow raceway pond design (“high rate pond” or HRP) was first introduced by Oswald and colleagues at the UC Berkeley Sanitary Engineering Research Laboratory (SERL) in the early 1950s for municipal wastewater treatment. These ponds are typically about 30 to 50 cm deep

(vs. 1 meter or more for oxidation ponds), and were initially mixed with centrifugal sump pumps. The first HRP system was installed in the City of Concord, Calif. in the late 1950s. A single half-acre HRP was constructed at SERL in the 1960s and was used to produce algae that were harvested with a centrifuge.

As already mentioned, paddle wheel mixing for HRPs was introduced in Germany during the 1960s with small raceway ponds and used in the mid-1970s at the SERL HRP pond (Figure 3.2) to test “bioflocculation” harvesting (Section 3.1.1.) at the pilot scale (Benemann et al., 1980). Since that time, this basic design has been adopted by almost all commercial algae producers, as well as at several small wastewater treatment plants. Recently, experimental HRPs have been used to demonstrate bioflocculation harvesting technology in combination with nutrient removal and biofuels production at California Polytechnic State University in San Luis Obispo (Woertz et al., 2009).

Design parameters have been developed over the past decades that pertain to HRPs for use in large-scale algae biofuel production. To approach maximal economies of scale, individual growth ponds should be about 4 hectares in area. Currently the largest known ponds of 1.25 ha are just starting operations for biofuels production in New Zealand (Figure 3.5). Ponds should



Figure 3.5: Christchurch New Zealand, High Rate Ponds (Craggs and Park, 2009).

(Note: Four 1.25-ha ponds were built to produce algae biomass for conversion of biofuels.)

be between 25 cm and 35 cm in depth – lower depth results in large temperature variations, hydraulic mixing problems and, perhaps most critical, in too high a rate of out-gassing of CO₂. Optimal pond mixing has been shown to be between 20 and 30 cm/second of channel velocity. Higher rates of mixing consume too much energy and scour unlined ponds; lower velocities result in algae settling and would require too many carbonation stations. CO₂ is supplied from pure CO₂ or flue gas. The gas is sparged (bubbled) into a sump with a counter-current water flow. A pH controller keeps the pH and CO₂ level within an optimal range. Dilution rate (rate of influent addition and biomass removal) should be between 20% and 50% of the total raceway volume per day (Benemann et al., 1982a; Weissman et al., 1988). This basic high rate pond design is used in the present report (Chapter 5).

3.2.2. CLOSED PHOTOBIOREACTORS (PBR)

Photobioreactors were already dismissed in previous discussion as unsuitable for algae biofuel production, or even for production of higher value products, on economic grounds. However, many companies, academics and other researchers in algae biofuels R&D continue to promote closed photobioreactors as a viable option for algae biofuel production. Even the US Department of Energy has kept an open mind with respect to use of PBRs for biofuels production in its recently released Roadmap Report (US DOE NREL, 2010). Thus, presentation of further issues is appropriate.

PBRs can indeed be more productive, and thus require less land, than open pond systems, but only if the ambient temperature is below optimal and/or if the reactors are oriented vertically, creating some sunlight dilution. However any productivity increase from a vertical orientation is modest, not over 50%. However, as already mentioned above (Section 2.2.3) but worthwhile repeating, to achieve this increase in productivity the PBR area will need to be at least tripled, compared to a horizontal (flat) system. Vertical orientation reduces the productivity per unit area of PBR by half. For horizontal PBRs, there is no difference in productivity versus open ponds (Pedroni et al., 2004), as long as temperature was not a limitation. In brief, any productivity benefits of PBRs are minor; claims of many-fold higher productivities, compared to open ponds, are unsupported.

One, often stated advantage of PBRs is their much lower water use, compared to open ponds given the fact that the system is wholly contained and there are no direct evaporation losses. However, PBRs will retain more heat than open systems, and the only cost-effective means of cooling the algae culture in these systems is through evaporative cooling with water sprays, which would result in water consumption greater than open ponds during peak summer months. If cooling is through immersion in pools (i.e., deeper ponds) of water, then evaporative losses are somewhat lower (due to the higher heat capacity of deeper pools) but

not much different from open ponds. Another option is to grow thermophilic algae in PBRs, as first suggested in Burlew (1953). However, even for such strains some cooling may be required. More problematic, however, is that temperatures could be too low for thermophilic strains for much of the day (and night), which would impair productivity. Thermophilic algae have not yet been proven in mass cultivation; though they deserve further research (e.g. Weissman et al., 1998).

Finally, closed PBRs are thought to use CO₂ much more efficiently than open ponds, given that CO₂ cannot escape to the atmosphere from PBRs but does escape from open ponds. However, Weissman et al. (1988, 1990) showed that outgassing from open ponds can be minimized, while for PBRs the major issue becomes O₂ management. Removal of O₂ requires large degassing stations, a major cost factor and design limitation (Weissman et al., 1988). In the final analysis, it is the cost of production that is critical, and there is no basis on which to consider closed systems for biofuels production. Of course, PBRs will be useful for the production of the initial stages of the inoculum, but that is a small part of the overall algae production process.

CHAPTER 4: RESOURCES AND REGULATIONS

4.1 RESOURCES CONSTRAINTS AND OPPORTUNITIES

The commercialization of algae biofuel production will be constrained by the economic and technical challenges, addressed in detail in the next section, as well as four main resource constraints: climate, water, land and CO₂, which will vary widely between geographic regions and for specific locations. Assuming, that a satisfactory, cost-effective, technology for algae biofuels is developed, the major issue will then be the actual resource potential of such a technology. Earlier work has examined the major factors that influence siting decisions for inland open ponds in the conterminous United States (Vigon, et al., 1982) and initial studies on the potential resources for algae production in the US Southwest has been carried out (Maxwell et al., 1985). However, much more detailed assessments are needed to evaluate the potential resource base and constraints of algae biofuels. Also, the potential environmental impacts and sustainability, in particular the net energy analysis and greenhouse gas balances of algae biofuels, e.g. the life cycle analysis, must be considered in some detail.

The general schematic for algae biomass production for biofuels and co-products is shown in Figure 4.1. (Harmelen and Oonk, 2006). Perhaps the most important requirement is good climate, that is a combination of insolation (in particular sunshine hours) and temperature regimes (diel and seasonal variations), as not important factors (humidity /rainfall must also be considered) that results in, if not maximal, at least acceptable productivities over a long growing season (e.g., close to 300 days per year). The response of microalgae productivity to pond temperature is uncertain, and presents a major limitation in any resource analysis.

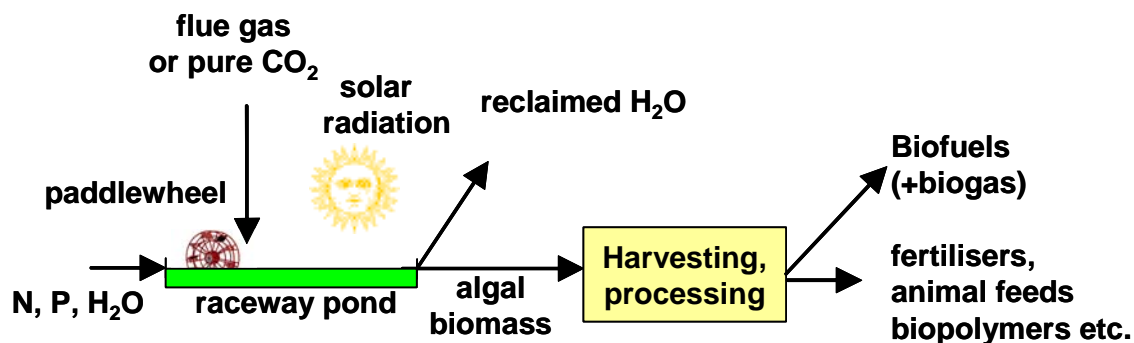

Figure 4.1. Schematic of an algae biofuel production process (Harmelen and Oonk, 2006).

This section considers resource constraints and opportunities at three scales of analysis – (a) global; (b) pertaining to the continental US; and (c) specifically the State of California.

4.2 CLIMATE

4.2.1. TEMPERATURE AND SOLAR IRRADIATION

Solar radiance and temperature determine the length of the growing of the season and also directly affect algae productivity. Although algae survive over a wide range of temperatures, each strain has a particular temperature range for maximum productivity. However, the range of temperatures at which maximum productivity can be achieved for algae strains specifically selected for a given temperature regime is at present uncertain. Ambient temperatures averaging below 15°C, much of the area within the blue rectangle map overlay shown in Figure 4.2, were assumed in the Harmelen and Oonk (2006) study to be unfavorable for achieving high productivity. These climatic zones are mostly located between 37° north and south latitude and include many of the developing countries in central Africa, the Americas and south Asia.

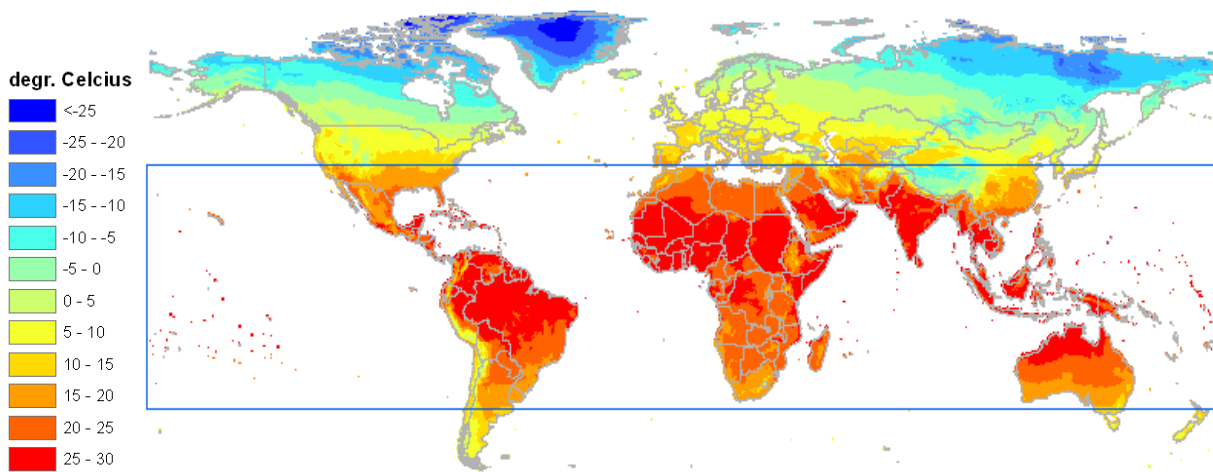

Figure 4.2: Temperature zones projected to be suitable for algae biofuel feedstock production corresponding to an annual average temperatures of above 15°C (Harmelen and Oonk, 2006).

Much of the southern US is shown to have mean temperatures suitable for algae biomass production, with areas of greatest potential the Central Valley of California, Florida and southern Texas. However, seasonal minimum daily temperatures (Figure 4.3) are a concern for the desert Southwest, because low night time temperatures result in low pond temperatures for much of the day, as it takes several hours for pond temperatures to rise to ambient levels. High temperature is also a concern in some areas, in particular where high humidity limits evaporative cooling and results in pond temperatures approaching, or even exceeding 40°C.

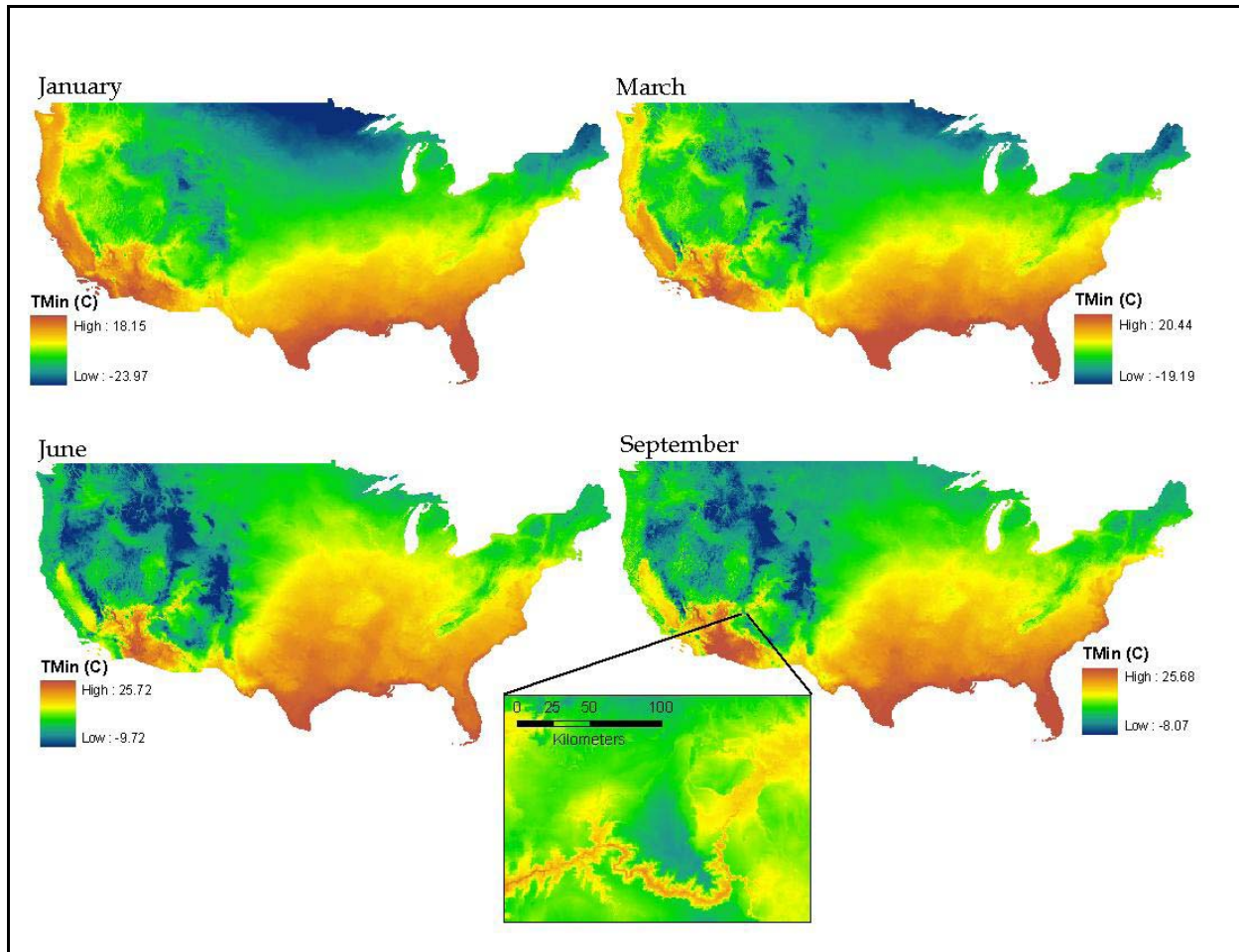

Figure 4.3: Seasonal minimum temperatures for algae biomass production within the US (Pate, Sandia National Laboratory, 2008).

As stated above, there is at present significant uncertainty whether algae strains can be developed that will exhibit high productivities at the diel temperature ranges that would be experienced in outdoor algae production ponds, where there is either a low or high temperature regime. One reason for this uncertainty is that there has been relatively little effort to screen and select for strains exhibiting high productivity at lower temperatures, a topic that requires considerable more research.

In the case of solar radiation (Figure 4.4), the relationship between insolation and productivity is less uncertain. As can be noted, the areas with highest average annual solar insolation also correspond to those with highest temperatures, although the correlation is not a strong one. For example, the highest average temperature zones, e.g. southwest Texas and southern Florida, are not the ones with the highest insolation, in part due to the high degree of cloud cover in these humid areas. A better correlation with productivity could be total number of hours of sunshine rather than total solar insolation, as full sunlight is not used as efficiently as

weaker sunlight (the ‘light saturation effect’). However, the major objective of algae biomass production is to achieve high solar conversion efficiencies, which would be achievable only by overcoming the light saturation effect, a long-term R&D goal (see further next chapter). In any event, as for temperature, the US has ample areas of sufficient sunlight to not be a major restriction on the potential of algae biofuel production.

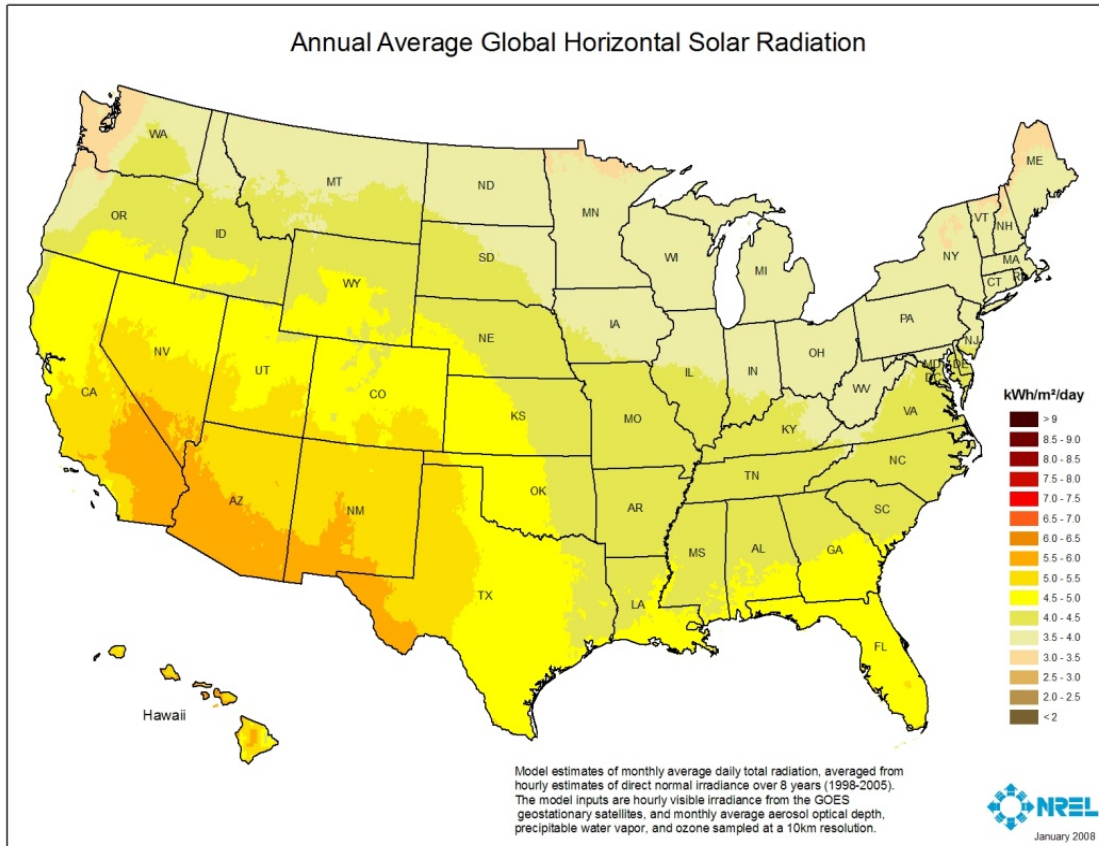

Figure 4.4: Annual average horizontal solar radiation for the continental US (Pate, Sandia National Laboratory, 2008).

4.2.2. EVAPORATION

The evaporation from outdoor algae ponds is a function of, mainly, air temperature, wind and relative humidity. Evaporation from reservoirs can be estimated from standard evaporation (“Pan A”) data after applying correction factors (e.g. for humidity, wind speed, etc.). However, algae ponds are not reservoirs, being much shallower and mechanically mixed, and thus are expected to have higher evaporation rates. The maximum evaporation rate in the US is typically found in Yuma, Arizona – with annual losses of up to 12 ft (~3.6 m) recorded, though

more typically net annual evaporation rates are 6 to 8 feet (~1.8 – 2.4 m) in most of the areas considered suitable for algae biofuel production.

Evaporation rates affect the “blow-down” ratio (BDR), defined as the volume of water discharged divided by the volume of water supplied to the pond, which is set to ensure that water salinity does not reach a point above optimal for algae productivity. A low BDR of 0.1 results in pond (and effluent) salinity to be ten times (1,000%) higher than that of the influent water, while a high BDR of 0.9, would produce a pond and effluent salinity only 10% higher than the concentration to the influent water. As the salt content of the influent water is generally a given, algae strains that exhibit high productivity at a salinity resulting in a low BDR would be desirable. Environmental regulation for salinity, other salts and trace elements may affect the operations of future commercial facilities (see Section 4.5). Figure 4.5 provides an evaporation dataset based on annualized pan evaporation averages, interpolated from various weather stations in the US for the period 1956-1970. Figure 4.5 shows a similar spatial pattern as mean annual solar irradiance and temperature with the highest values recorded for south-eastern California, southern Arizona, southern New Mexico and much of western Texas.

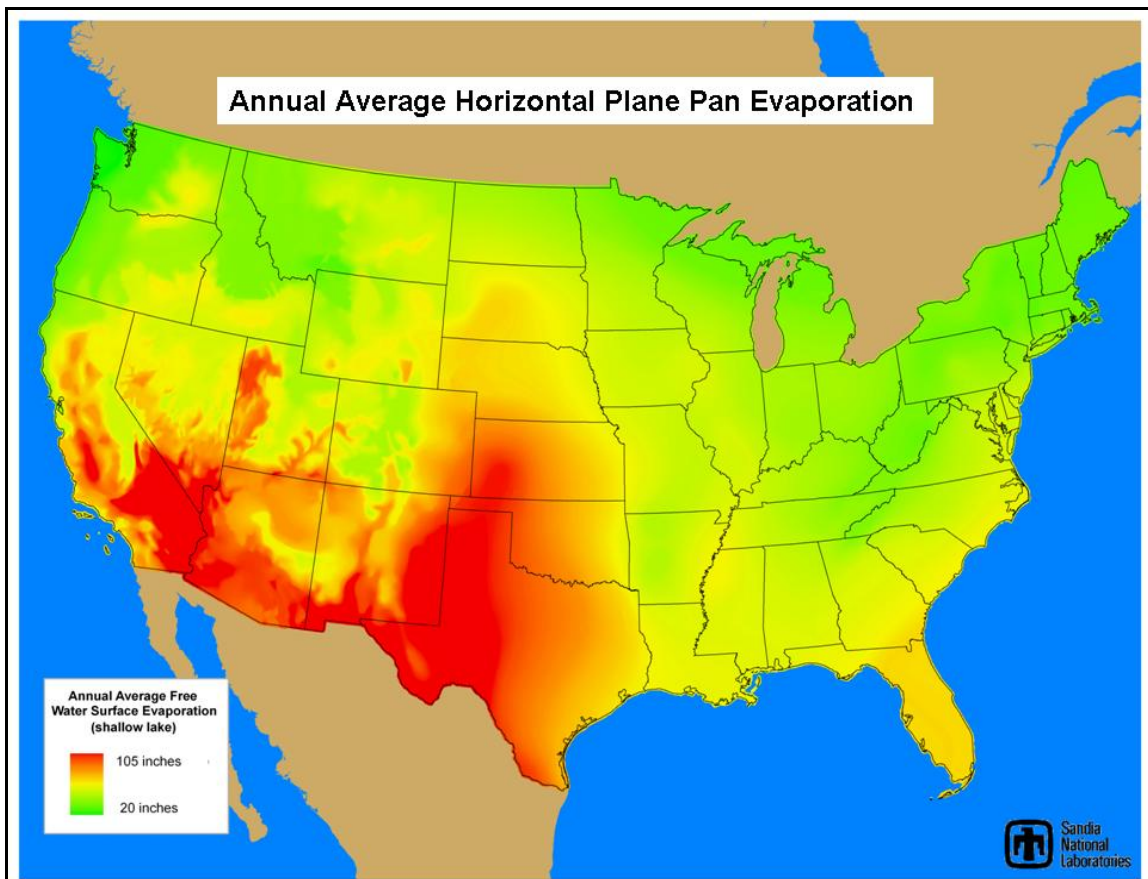

Figure 4.5: Annual average pan evaporation rates for the US (Pate, Sandia National Laboratory, 2008).

4.2.3. WATER AND NUTRIENT RESOURCES

A reliable, ample and low-cost water supply is a critical for algae biofuel production. A water supply is necessary to make up for water lost through evaporation and blow down. One of the important factors that set algae biomass production technology apart from technologies reliant on terrestrial crop production is the ability of algae to utilize water of poor quality, unsuitable for crop production, which generally means brackish and higher salinity inland waters and ocean seawater. For inland locations, to be sustainable the water supply for algae biofuel production would depend on annual recharge to surface and groundwaters. Areas with abundant precipitation such as the south-east of the continental US, are not constrained by water availability. However in these areas overcast conditions can reduce the availability of sunlight to sustain optimal photosynthetic growth and high humidity can reduce evaporative cooling of the ponds, thus potentially raising temperatures above those tolerated by the algae strains employed. In the arid south-western US competition for fresh water resources is acute, and the cost of water generally too high for use for biofuel production, even if there was no political issue regarding the competition of fuel and food (actually commodity feeds).

The economics of groundwater supply as a source of water for algae biofuel facilities depends on the depth of pumpage, hydrogeological conditions such as well sustainable yield and level of regional exploitation of the resource. The ASP (Aquatic Species Program) was essentially based on the notion of using fossil brackish groundwater sources, assumed to be present in enormous quantities in the US Southwest. This assumption needs to be validated before such water resources are again considered as a major water resource for algae cultivation in these regions. Also, such brackish groundwater resources would be considered “mining” of non-renewable water resources, and thus would not be, by definition, “sustainable,” a major consideration.

In many states, such as California, groundwater resources are not adjudicated – which can lead to over-exploitation of the resource. If groundwater aquifer resources are utilized as a means of providing water supply to an algae biomass facility – the long-term sustainability of the resource needs to be considered. The map in Figure 4.6 shows the freshwater aquifers being mined by excessive groundwater withdrawal as well as the areas that are being affected by salt intrusion. In many of these aquifers that experience inadequate recharge, poorer quality water eventually displaces the water withdrawn from the aquifer. In areas that are both stressed and affected by poor groundwater quality – land subsidence may result if water levels are reduced below historic low elevations. Most land subsidence occurs within the fine clay aquitards of groundwater basins and is a result of reduced pore water pressure – whereby the compression loading of the overburden exceeds the compressive strength of the aquifer bed materials. The cost of land subsidence can be prohibitive in areas that rely on surface delivery of water supply. Inland brackish water resources for the continental US are shown in Figure 4.7.

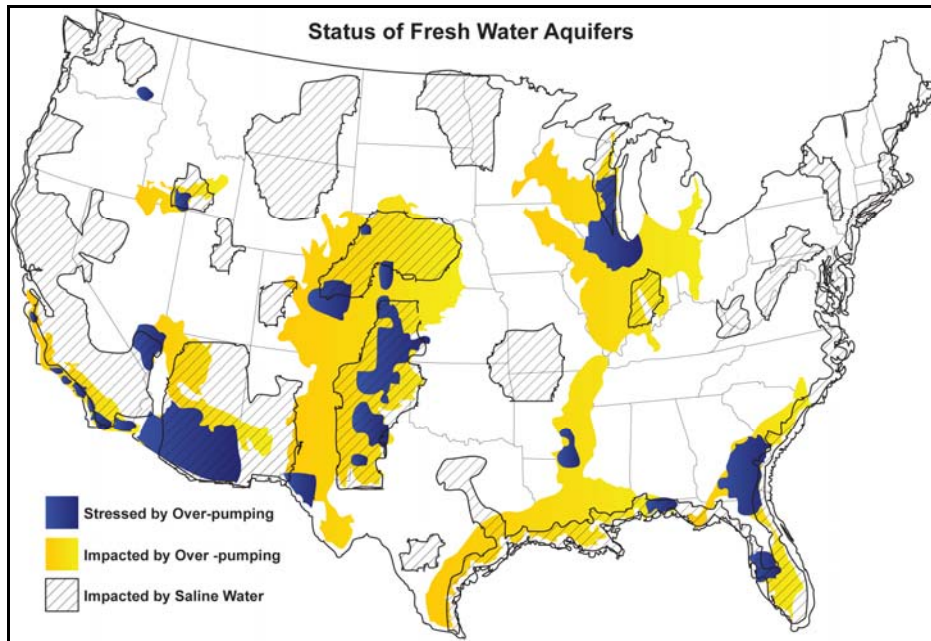

Figure 4.6: The current state of groundwater aquifers within the continental US showing areas of acute stress (where withdrawal exceeds recharge), areas impacted by groundwater pumping and areas affected by salinity intrusion (Pate, 2008).

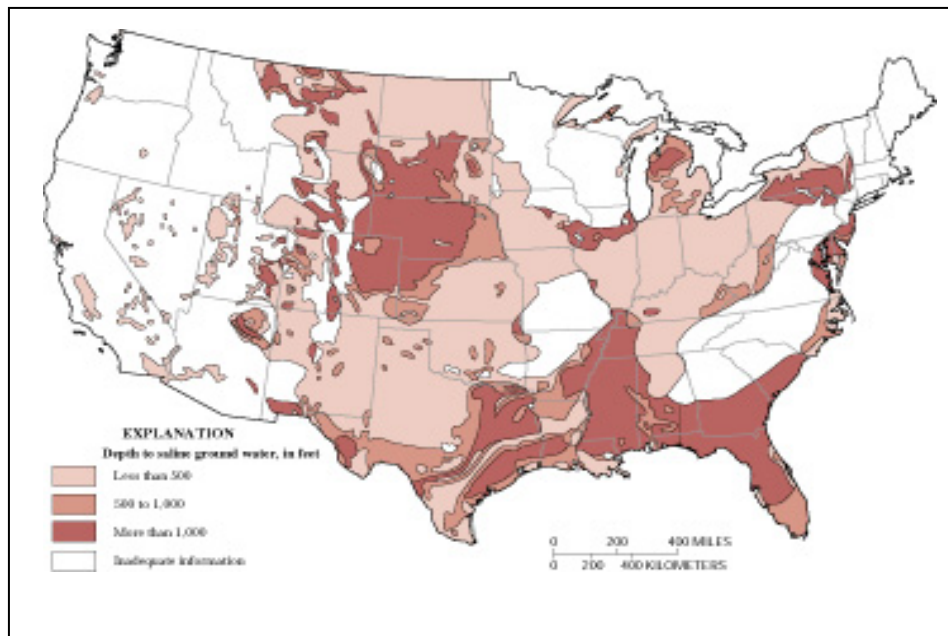

Figure 4.7: Saline aquifers in the continental US. Brown shading refers to the depth of the aquifer. With appropriate treatment, inland brackish water resources could be an important source of water for algae biofuel production (Pate, Sandia National Laboratory, 2008 – data derived from Feth, 1965).

Brackish water could be an important source of water for algae biofuel production, although it may require pre-treatment if the chemical constituents of the water inhibit algae growth. Brackish water resources are not typically in high demand for agricultural uses. However, in some areas these saline aquifers may underlie better quality water resources, where increased withdrawal of the underlying water might exacerbate an existing over-allocation problem, such as the states sharing the Ogalla Aquifer.

A number of water resources would not impact on fresh water resources. Municipal, industrial and agricultural wastewaters, agricultural drainage and brackish and seawater resources can all be considered in developing low cost algae production systems where water scarcity is an issue. For example, saline “produced” water from oil, natural gas or coal-bed methane wells are possible water resources for algae biofuel production – the salinity of these groundwater supplies is typically too high for use in agriculture. Another possibility is co-location of algae production facilities with deep well injection sites for carbon sequestration, which could provide algae with a sustainable source of saline water that would be displaced to the surface by the liquefied injected carbon. Deep well injection of carbon can only occur in aquifers containing a minimum of 10,000 ppm salinity – groundwater that could easily sustain many both fresh and salt water species of algae. A map of produced water resources is shown in Figure 4.8 – the map discriminates between oil and gas fields. The preponderance of these produced water fields are in Texas and the lower mid-west with a smaller area in the Sacramento and southern San Joaquin Valleys.

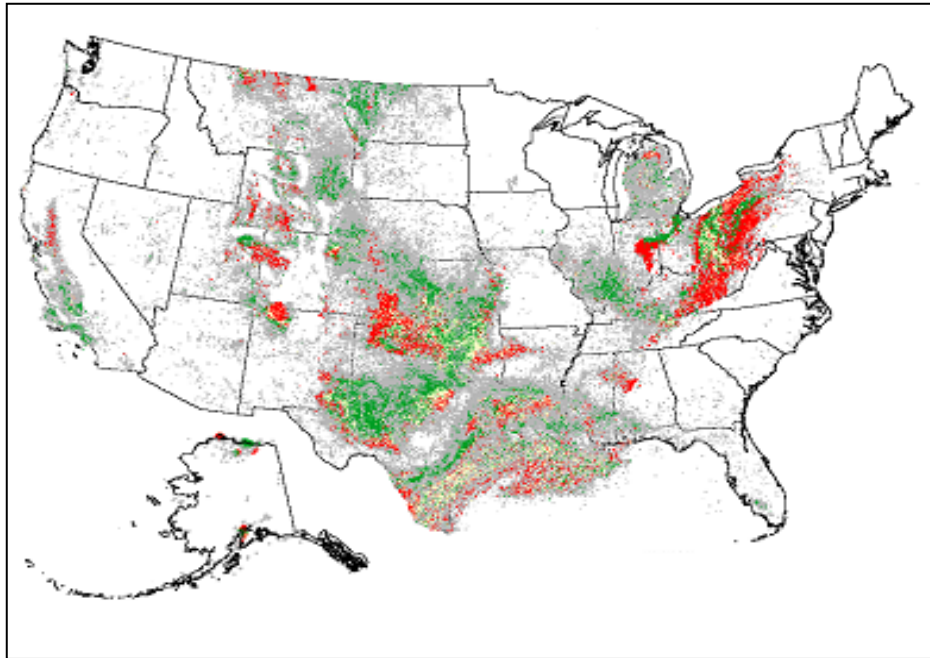

Figure 4.8: Map of produced water resources from energy mineral extraction – (green – oil; red – gas; yellow – mixed) (Pate, Sandia National Laboratory, 2008).

In some circumstances, algae biomass production can generate income from the treatment of wastewaters, in particular municipal wastewaters, as discussed in the following chapters, and indeed is the basis of this report. Tax credits and energy rebates can also help improve the bottom line. On the downside, discharges from algae production facilities using wastewaters will be closely regulated and this will increase capital, operational and maintenance costs. In the case of seawater utilization in coastal areas, the blow-down ratio would be rather high: salinities in the ponds should be not much higher than ~50 % above seawater levels, requiring a considerable discharge back into the ocean. Although not a significant environmental issue, such discharges may still be limited by regulations established for other consumptive industries. An open pond, with an evaporation rate of 1 cm/d, would use 1 million liters water/ha-d, plus the blow-down requirements. For freshwater inputs, the total consumption would be only 10% higher, while for seawater systems, total water use would be two or three times higher.

Table 4.1 provides typical values for the water, CO₂ and nutrient supply inputs to an algae biomass production facility based on an assumed algae biomass composition for C, N and P, as well as productivities, for near-term and long-term projected algae production processes.

Table 4.1: Typical resource needs for a typical outdoor algae biomass production facility.

Parameter	in dry ash-free biomass	Remarks/reference
Algal biomass composition	45 -50% C, 4-10% N, and 0.3 - 1.2% P	Algae C and N content depending on oil content, P content on supply.
Water, wastewater utilization/ reclaimed water production	2.5 m ³ wastewater per kg of algal biomass (dry)	assuming 40 g m ⁻³ N, typical in municipal wastewater (Chapter 4).
CO ₂ utilization	2.0 kg CO ₂ per kg 0.7 kg CO ₂ m ³ wastewater	90% overall CO ₂ utilization (uptake in algal biomass/fed to the system)
Algal biomass productivity	50-100 Mg ha ⁻¹ y ⁻¹ annual productivity, 20 – 40% oil content	Currently achievable to future projected productivities (Benemann and Oswald, 1996, see Chapter 4)
Energy & products	240 kg CH ₄ /mt of algae residues from anaerobic digestion (660 m ³ biogas) 10 kg P and 100 kg N per ton of algae residue from anaerobic digester residue	assuming 70% dissimilation of organic material in anaerobic digester obtained as a solution recycled back to the growth ponds
CO ₂ mitigation upon utilization	1.35 kg CO ₂ per kg algae biomass processed in anaerobic digestion	Includes 3.5 kg of CO ₂ / kg of N recycled in the algal biomass (see Benemann, 2003).

For example, for an average total nitrogen concentration of 40 g/m³ in wastewater and 5 to 10% N content in the algae biomass (ash-free dry weight, depending on lipid content), 1.25 to 2.5 m³ of wastewater would be required per kg of algae biomass produced. It should be noted that these are general values, in particular P cell levels can be very flexible, ranging from 0.3 to 1.2% without changes in productivity, depending on the process objective (e.g., to remove P or use P efficiently). One of the important conclusions of such analysis is that for production processes not based on nutrient recovery from wastewaters during a treatment process, algae biofuels production cannot afford to waste such nutrients in a “once-through” process. Nutrients must be either recycled, to produce more algae biomass, an efficiency of >90% can be assumed, or used in the co-production of animal feeds. With such provisions, cost or supply of agricultural fertilizers would not be a limiting factor in algae biofuels production.

4.2.4. LAND RESOURCES

Land requirements are thus for large tracts of nearly flat land, with clay or similar low permeability soils. The footprint of algae production facilities would typically be several hundred hectares (except for wastewater treatment facilities, which could be significantly smaller, see Chapter 5). Candidate sites should be level or nearly level since terracing would require significant expenditure for earth moving to construct the ponds. A large slope would also require additional pumping costs for water supply and recycling. Soil characteristics are also important, with sandy soil, resulting in high percolation rates, being unsuitable. Ponds will tend to be self-sealing, and sandy soils could be sealed with a thin clay liner, at additional costs.

Land costs are a further issue. However, in light of the high capital costs of such systems, land costs of even \$10,000/ha (\$4,000/acre) would not make a large (e.g. <10%) difference in capital costs (and an even smaller, <3%, change in overall costs). The cost of land is related mainly to location, alternative uses, and ownership. In the US Southwest large tracts of State and Federal land, potentially available for such renewable energy projects, are located in the more arid and less densely populated areas, lands of typically low fertility, limited water resources and generally poor access and infrastructure (power supplies, roads, etc.). For wastewater treatment land costs will generally be higher, as they would be located near population centers. However, the wastewater treatment function would also allow for greater investment in land. In brief, land costs will be a significant factor in many cases, along with other location factors, such as access to power and roads, and most importantly CO₂ and water, but how much land costs would reduce the overall algae biofuels resource potential remains to be determined.

The potential availability of suitable land on a global basis is illustrated in Figure 4.9 (Harmelen and Oonk, 2006) which shows land masses located at elevations of less than 500 m (1500 ft). This was assumed to be an indication of favourable topography, though, of course, that is only a general guide. A similar map for the continental US is shown in Figure 4.10 shows tracts of

lands of over 1 km² (100 ha) with moderate slope. It can be noted that such locations are not dominant in the US southwest, but rather more prevalent in Florida and the Gulf states. Considering that these areas also have more available water than the US Southwest states, it would seem plausible to assume that future focus of algae biofuel production will gravitate to these regions. Climatic factors and CO₂ availability would also favour such locations.

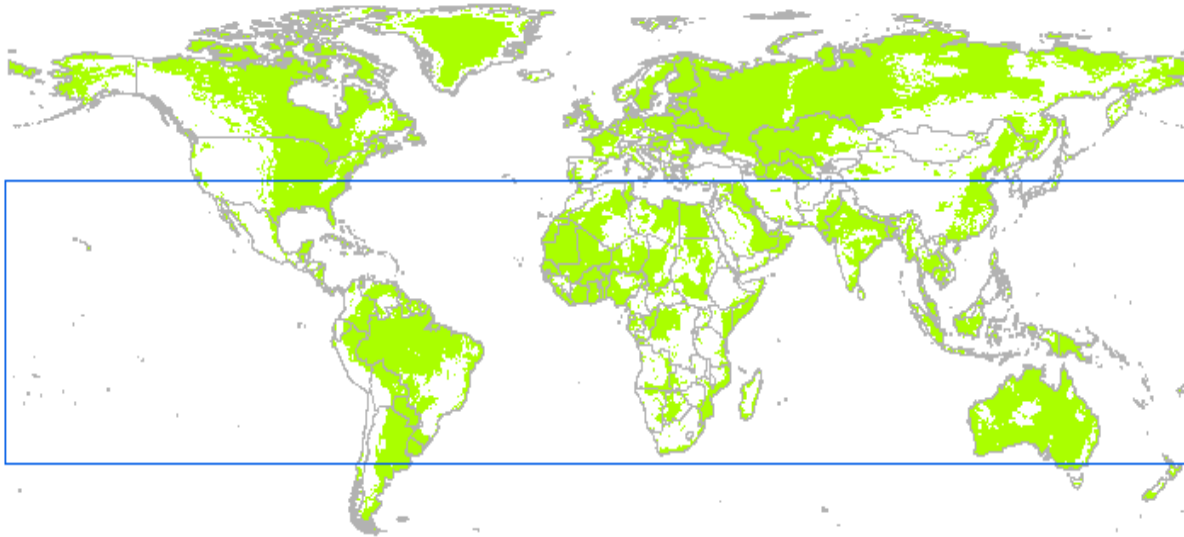

Figure 4.9: Land areas (green) located at altitudes lower than 500 m (1500 ft), assumed to encompass most areas with moderate slopes (Harmelen and Oonk, 2006).

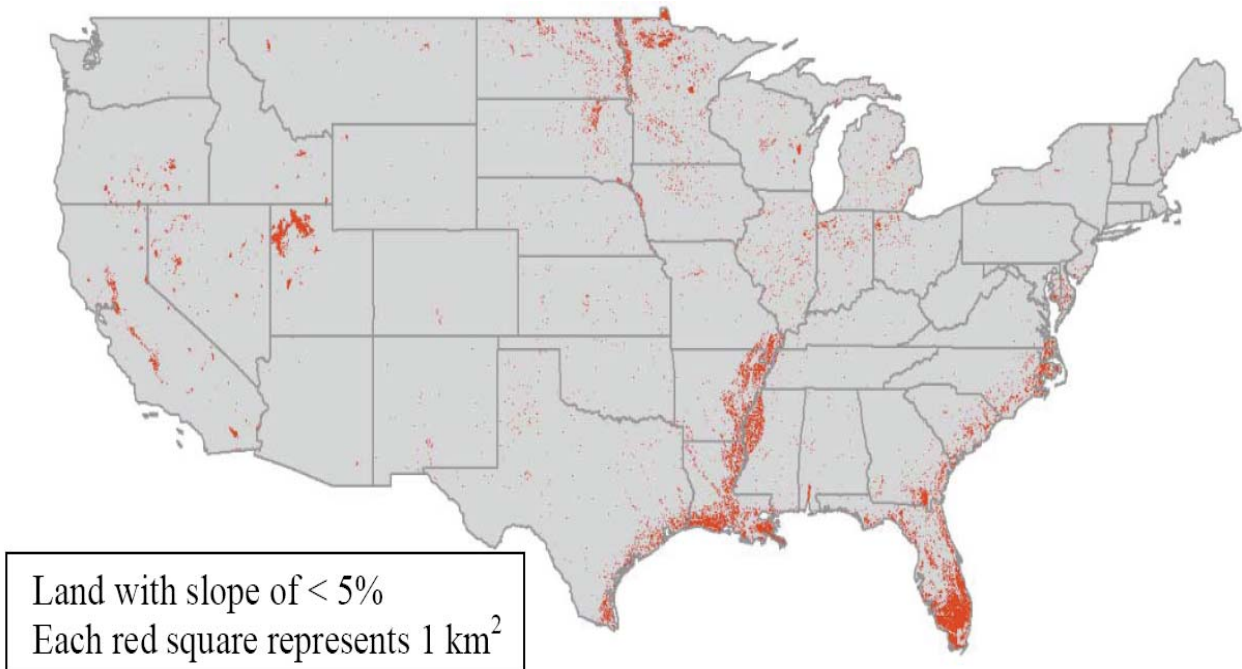

Figure 4.10: Areas with 1 km² (100 ha) areas of flat land located with less than 5% slope in the continental US. Total area is ~23 million hectares (Pate, Sandia National Laboratory, 2008).

Of course, such conclusions based on large-scale features are only indicative; selection of specific suitable areas for algae biofuel production will be based on many site factors, of which slope and cost are only two of many. Some locations would be able to accommodate tens of thousands of acres of algae production facilities, such as near the Salton Sea, in southern California (see Section 4.3, below), and Brownsville, Texas. Other regions will be limited to smaller, more dispersed systems of a few hundred hectares.

Without a much more detailed and focused analysis the potential land resource for algae biofuels either globally or in the US is at present uncertain. However, visions of many tens of millions of hectares of algae biofuels production, even worldwide, let alone in the US, do not appear to be warranted, based on this preliminary, high level, analysis, even without considering the major limitations of water and CO₂ availability.

4.2.5. CARBON DIOXIDE

Carbon dioxide is a critical nutrient for all photosynthetic plants species, but all conventional higher plant production systems can obtain it from air, algae production is the exception in that it requires an enriched source, as atmospheric CO₂ is not sufficient. The reasons for this is the limited gas exchange at the pond surface interface, limiting productivity to well below the productivity achieved by higher plants, and the excessive energy that would be required to

provide CO₂ by sparging air through a culture system. Many sources of enriched CO₂ can be considered, from merchant (100%, compressed, liquefied) CO₂, to flue gas from power plants, the latter being the focus of most of the activities in this field. Other sources include wastewater treatment plants, ethanol plants and similar biorefineries, petroleum refineries, agricultural, urban and industrial solid waste facilities, and other such sources (Table 4.2).

Table 4.2: Identified Stationary CO₂ Sources from the NATCARB 2008 Stationary CO₂ Source Atlas (<http://www.natcarb.org/>).

CATEGORY	CO₂ EMISSIONS Million Metric Ton/Year	Number of Sources
Ag Processing	6.3	140
Cement Plants	86.3	112
Electricity Generation	2,702.5	3,002
Ethanol Plants	41.3	163
Fertilizer	7.0	13
Industrial	141.9	665
Other	3.6	53
Petroleum and Natural Gas Processing	90.2	475
Refineries/Chemical	196.9	173
Total	3,276.1	4,796

There is no lack of power plant flue gas CO₂ in the US, or globally, with a content of from 3 to 15% CO₂, with the lower ranges typical of natural gas power plants (3 – 5%) and the higher levels emitted by coal plants (9 – 14%, typical. As seen from Table 4.2, about 85% of US stationary CO₂ emissions derive from about 3,000 electricity generation plants, which, if fully utilized, could produce about 1.3 billion metric tons of algae biomass (@ 2 mt CO₂/mt algae), or almost 180 billion gallons of oil (@ 40% oil in the algae biomass), close to total current US transportation fuel consumption. Unfortunately not much of this enormous CO₂ resource could be used for algae biofuel production, due to many limitations:

1. Most power plants, and thus CO₂ emissions, are not located in climatically favorable areas.

2. Few such power plants have nearby the large tracts of land and water resources required. over 10,000 ha (e.g. 100 km²) for a 1 GWe coal-fired power plant.
3. Flue gas from gas-fired power plants, with a low CO₂ content, requires more energy for their transfer into the algae cultures.
4. Even piping flue gases with 10 – 15% CO₂ content (e.g. from coal-fired power plants) for any distance, is limited by either the blower energy or pipe sizes required (Benemann et al., 1982).
5. Due to diel and seasonal variations in CO₂ utilization by the algae, on an annual basis only a fraction, about a quarter, would actually be captured in the algae biomass
6. A large fraction (about a third) of the CO₂ is captured in algae biomass that is not oil.
7. There are unavoidable CO₂ losses during gas transfer and due to outgassing from the ponds.

Thus, for the US well below 10% of the actual resource base would be available due to climatic, water and land limitation. Even were climate is favorable and land and water available, on an annual basis the utilization of CO₂ from flue gases from power plants into algae biofuels, would be not much higher than 10%, to at most 15%. Even if carbon is recycled from the algae residues after oil extraction, the best case scenario would be about 25%, requiring more land area and water, of course. Considering all these factors, even a 1% conversion of US, or for that matter global, power plant flue gas CO₂ into algae biofuels would be wildly optimistic. A more realistic projection would be a small fraction of one percent, some hundreds of millions, not billions, of gallons of algae oil derived from power plant CO₂ flue gases.

There are, however, many other, generally much smaller, stationary sources of CO₂ (Table 4.2 and Figure 4.11) that could be better used for algae biofuel production, in terms of scale, location and opportunity. Of course, it is unlikely that even these could be exploited to any large extent, as many of the above limitations also apply to these sources. However, even if the potential resource for algae oil production is overall even one percent of the total stationary CO₂ sources, this would correspond to about two billion gallons of algae oil. Not a solution to the energy needs of the US, but a sufficient contribution to justify the development of this technology, among many others, of course. In the future, it may be desirable to co-locate new stationary sources of fossil CO₂ where they can be best used for algae biofuel production. Such a scenario is analyzed in terms of greenhouse gas abatement for a 50-MW semi-base load power plant in Brune et al. 2009.

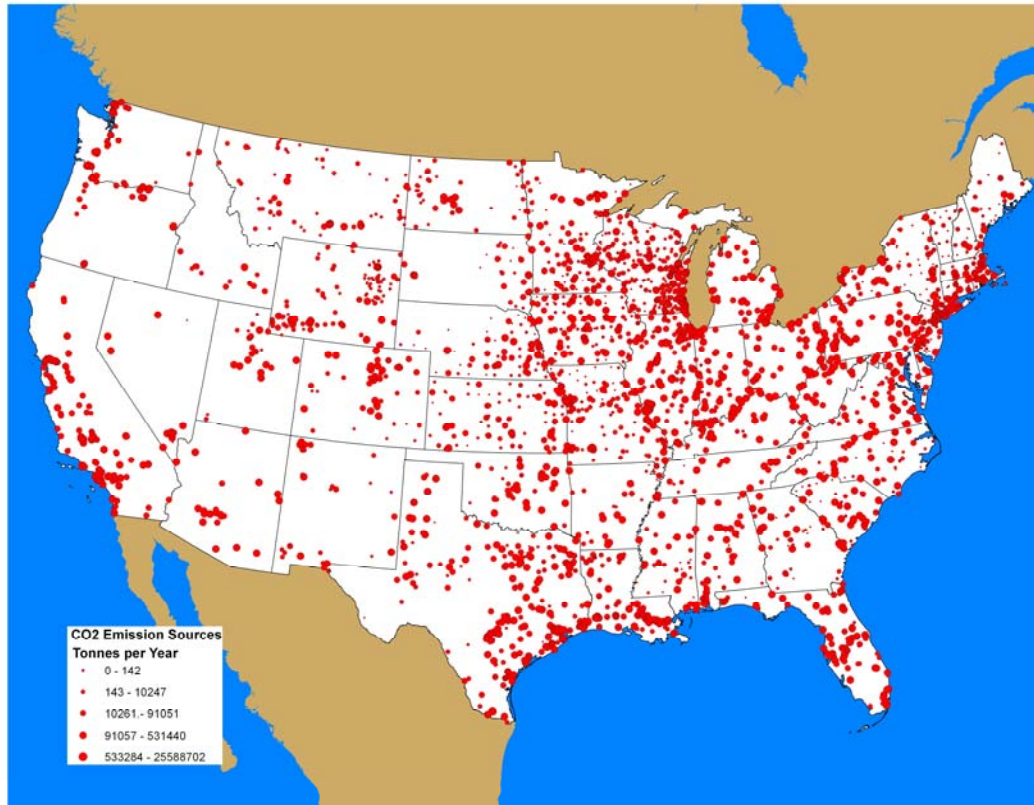

Figure 4.11: US CO₂ emissions sources – size of circular dots is scaled according to the size of the emission source. Most of the source lie in the range of 10,000 – 500,000 metric tons (tonnes) of CO₂/year (Pate, Sandia National Laboratory, 2008).

4.3 GIS ANALYSIS FOR ALGAE BIOFUEL PRODUCTION IN CALIFORNIA

Remote sensing (RS) and geographic information systems (GIS) have been used previously to develop resource availability models for a number of fuel crops including algae. A typical geospatial approach called suitability analysis involves integrating a variety of spatial and non-spatial data to determine suitable land for project development (NC Division of Coastal Management, 2005). For example, suitability analysis approaches have already been used to select sites for bioethanol processing centers (Koikaj, 2008) and algae plants (Maxwell et al., 1985; Pate, 2008). In the present study GIS methods were employed for an analysis of resource availability in California - overlays of land suitability were developed using economic and environmental factor assumptions to show potential for algae biofuel production.

Available resource data were collected from a variety of sources and used to identify optimal regions. GIS attribute layers were obtained from the following sources: California Spatial Information Library (hydrology and roads), National Renewable Energy Laboratory (NREL) at

www.nrel.gov/gis/data_analysis.html (solar radiance), WorldClim.org (temperature), Farnsworth *et al.* 1982 (water evaporation), US EPA eGRID 2007 at <http://www.epa.gov/cleanenergy/energy-resources/egrid/index.html> (carbon dioxide emissions), USGS National Landcover Dataset (land use/land cover), US Bureau of Reclamation (USGS digital elevation model), the National Energy Technology Laboratory (NETL) at http://www.natcarb.org/Atlas/data_files.html (saline aquifers) and the EPA Clean Watershed Needs Survey (CWNS) at <http://www.epa.gov/cwns/2004data.htm> (WWTP). The only suitable groundwater resources that are not subject to current over-exploitation in California are deep saline aquifers. Given the high cost of water in California resulting from the fierce competition for high quality water supply between municipal, agricultural, industrial and environmental uses – wastewater resources were targeted as the most likely potential water sources for algae biofuel production. For the analysis water from a wastewater treatment plant (WWTP) was assumed to have nitrogen concentrations as indicated in Table 4.1.

Point locations of all California WWTP were mapped within the GIS. Only areas located within a 3 mile radius of the WWTP were evaluated since beyond 3 miles, capital costs for piping and O&M power costs to supply the water become too costly. Right of way issues also become more burdensome as the length of pipeline increases. For instance, groundwater pumping with a lift of 75 feet (an average lift from the sub-Corcoran aquifer in drainage impacted areas in the Central Valley of California) with an average pipeline conveyance of 3 miles for a 1,000 acre (400 ha) system, would cost approximately \$31 million. This is roughly equivalent to the facility costs cited by Vignon *et al.* (1982) when adjusted for inflation. Multiple ring buffers were created around each WWTP using the ArcGIS 9.2 Buffer Wizard at distances of 1, 2, and 3 miles - areas beyond 3 miles were excluded from further inclusion in the analysis.

Another wastewater source is irrigated agriculture, which produces so-called tile drainage water, at the rate of about 0.3 (range 0.2 – 0.4) acre-ft/acre-yr, depending on the irrigation technology deployed, the crop grown and the intensity of irrigation management. The analysis assumed an combined evaporation loss and blow down rate of 72 in/yr, based on pan evaporation data in the Central Valley for the time period 1956-1970 (55 inches) and an estimated blow-down requirement. Thus 20 acres of irrigated agricultural land are needed to supply the water for one acre of algae ponds, or 20,000 acres for a 1,000 acre (400 ha) algae pond system. The agricultural irrigation water used in this area would allow operation of over a dozen such plants around the Salton Sea, a favorable location also from climatic and land slope and type perspectives . It should be noted that the removal of N and P from such agricultural drainage waters can be a significant environmental benefit (Benemann *et al.*, 2003). Other water resources, such as brackish waters, are not considered herein, as they present significant environmental challenges. Similarly seawater resources are almost unobtainable in California due to the high population density near the coasts, among other factors.

Land availability limits analyses to areas that are currently not developed and have land slopes less than 5%. Areas with an average slope greater than 5% were not considered since excavation and grading costs are prohibitively expensive on marginally and highly sloped lands. Suitable land slope was derived from a 30 m digital elevation model of California using the ArcGIS Spatial Analyst toolbox. Land cover information was obtained from the National Landcover Dataset as Landsat imagery with a 30 m resolution. Land cover types listed as “wetlands” and “highly developed” were among those considered unsuitable for algae production facilities. Only land classified as agriculture, developed-open space, shrub/scrub, herbaceous, and bare land were considered. Irrigated agriculture was prioritized as a land cover type since agricultural drainage is an important potential source of water supply. Proximity to roads was also considered. Servicing algae production facilities is costly if they are located in areas that poorly accessible by road. Areas beyond a 1.5 mile distance to a California road were also eliminated from analyses. Buffers were created at distances 0.25, 0.5, 0.75, 1.0, and 1.25 miles from public roads. This constraint might be relaxed in future studies.

Locations of all California power plants producing CO₂ were mapped within the GIS. At over 3 miles, the cost of conveyance becomes very costly, similar to the costs incurred conveying water supply (Benemann and Oswald, 1996). Multiple ring buffers were therefore created around power plants at distances of 1, 2, and 3 miles excluding all land outside of these buffers from analyses. No other CO₂ sources were evaluated for this study but should be in the future.

After collecting the necessary GIS files, the raw data were input into ArcMap 9.2. Since some of the files were served up in Arc/Info .E00 interchange file formats, they needed to first be converted to a coverage format using ArcCatalog’s ArcView Import from Interchange File toolbar. All data were projected using the USA Contiguous Albers Equal Area Conic projection to minimize area distortion and set using the North American Datum 1983, a common datum used for projects in North America where raw data has been collected. File coverages were clipped to fit the map extent of California using a boundary layer for CA obtained from the US Census Bureau at <http://www.census.gov/geo/www/cob/st2000.html> and using the raster calculator to limit the map extent of each coverage to fit the boundary. All GIS coverages were converted to a raster format in order to use the spatial analyst reclassify and weighted overlay tools. All vector-based data were converted to raster format using a pixel size of 30 m by 30 m. Each individual data layer was then classified by a range of suitability values using a five-class, natural breaks classification scheme, a common classification method used to reduce variance within a group of data while increasing variance between groups (Table 4.3). Extreme values such as very low temperatures or slopes greater than 5% were eliminated from analyses. In order to combine GIS layers they need to be in the same units. All classified values were reclassified according to a common suitability scale (1 – 5, with 1 most suitable to 5 least suitable (Table 4.3).

Since not all layers were of equal importance, all reclassified data had to be weighted to reflect their relative importance from an engineering-economics perspective. Capital and Operations and Maintenance (O&M) costs were used to assign weights to the various factors, with higher weights being given to those coverage factors that were higher in relative cost (Table 4.4). Individual weights were defined by taking the combined capital and O&M costs for a single coverage factor and dividing that value by the total capital and O&M costs for the entire algae biomass production facility. The cost for power was assumed to be \$0.065/kWh (Benemann and Oswald, 1996), while an 8% capital charge over 30 years is assumed. The cumulative weight totaled 100%. An assumption was made that the \$20,000 water-derived O&M costs listed in Benemann and Oswald (1996) should be broken down to reflect the high power costs of groundwater pumping; therefore \$15,000 of the water-related power costs was assigned to pumped groundwater sources and \$5,000 was assigned to surface water sources. The primary map output was created using only weighted GIS layers in Table 4.3.

Monthly temperature and evaporation, and annual solar radiance values had no associated cost data, so those coverage layers were weighted separately (Table 4.5). The temperature and evaporation data represented historical averages for the month of March. Only averages for March minimum temperature were used because the growing season for algae is more seriously constrained by low temperatures than high temperatures. Evaporation and solar radiation, the primary climate constraints, were assigned higher weights than temperature because algae can thrive in environments over a wide range of temperature conditions. Since these climate constraints directly influence only surface water availability, the original weights assigned to WWTP and irrigated agriculture had to be readjusted in the separate model.

Table 4.3: Classified data by range of values using natural breaks. All classified data were then reclassified to a uniform scale using the ArcGIS Spatial Analyst reclassification toolbox.

GIS Layer	Classified	Reclassified
Land Use	Cultivated Crops	1
	Barren Land	2
	Shrub/Scrub	3
	Herbaceous	4
	Developed—Open Land	5
Distance to Roads (mi)	0.25	1
	0.5	2
	0.75	3
	1.0	4
	1.25	5
Slope (%)	1	1
	2	2
	3	3
	4	4
	5	5
Distance to WWTP (mi)	1	1
	2	2
	3	3
Distance to Flue Gas Source (mi)	1	1
	2	2
	3	3
Solar Radiation (Wh/m ² *day)	3456 – 4131	5
	4131 – 4518	4
	4518 – 4815	3
	4815 – 5265	2
	5265 – 5868	1
Monthly Temperature (°F)	30 – 35	5
	35 – 40	4
	40 – 42.5	3
	42.5 – 45	2
	42.5 – 52	1
Yearly Evaporation (in)	27 – 44	1
	44 – 56	2
	56 – 70	3
	70 – 86	4
	86 – 105	5
Saline Aquifer	1	1

Table 4.4: Cost breakdown affecting the weights assigned to different GIS coverages. Total weight sums to 100% giving greater weight to higher cost factors. Primary assumptions are that water/CO₂ is pumped at a distance of 1 mile. These values were based on pond-based algae productivity of 30 g/m²-day. Values were taken from (Benemann and Oswald, 1996) and modified to reflect a 100 ha system and a 2009 \$ cost basis. CO₂ and water-related capital costs were provided by from the current report.

Costs (\$) for a 400 ha (1000 acre) algae production facility.					
Activity	GIS Layers	Capital Costs (\$)	O&M Costs (\$)/yr	Amortized Capital Costs (\$)/yr	Applied Weight
Site Preparation	Slope	344,000	NA	2,524	1%
Road Construction	Road	276,000	NA	2,024	1%
CO ₂ Distribution/Supply	CO ₂ Emissions	1,200,000 (piping)	92,000	8,804	51%
Groundwater Pumping/Piping	Saline Aquifers	800,000 (piping)	60,000 (pumping)	5,868	13%
Surface Water Piping	Irrigated Agriculture; WWTP	800,000 (piping)	20,000 (piping)	5,868	33%
Land Costs	Land Use	276,000	NA	2,524	1%

Table 4.5: Weighting scheme used for all relevant GIS data. The wastewater treatment plant (WWTP) and irrigated agriculture layers given equal weights of 16%.

GIS Layer	Weight
Slope	1% (Can be relaxed in future)
Road	1%
CO ₂ Emissions	51%
Saline Aquifer	13%
Land Use	1%
WWTP and Irrigated Agriculture	16%
Monthly Evaporation	7%
Monthly Temperature	3%
Annual Solar Radiation	7%

The weighted GIS layers were combined in Figure 4.12 to suggest suitable locations for open pond algae production facilities that would be combined with harvesting and fuel conversion facilities to produce algae biofuel. Since the CO₂ and WWTP GIS coverage layers were buffered to exclude areas outside of 3 miles, the final map output illustrates only 3 mi² polygons of potential sources instead of broad swaths of land. The final map output (Figure 4.12) was generated using only those coverage layers that were weighted using relative cost data.

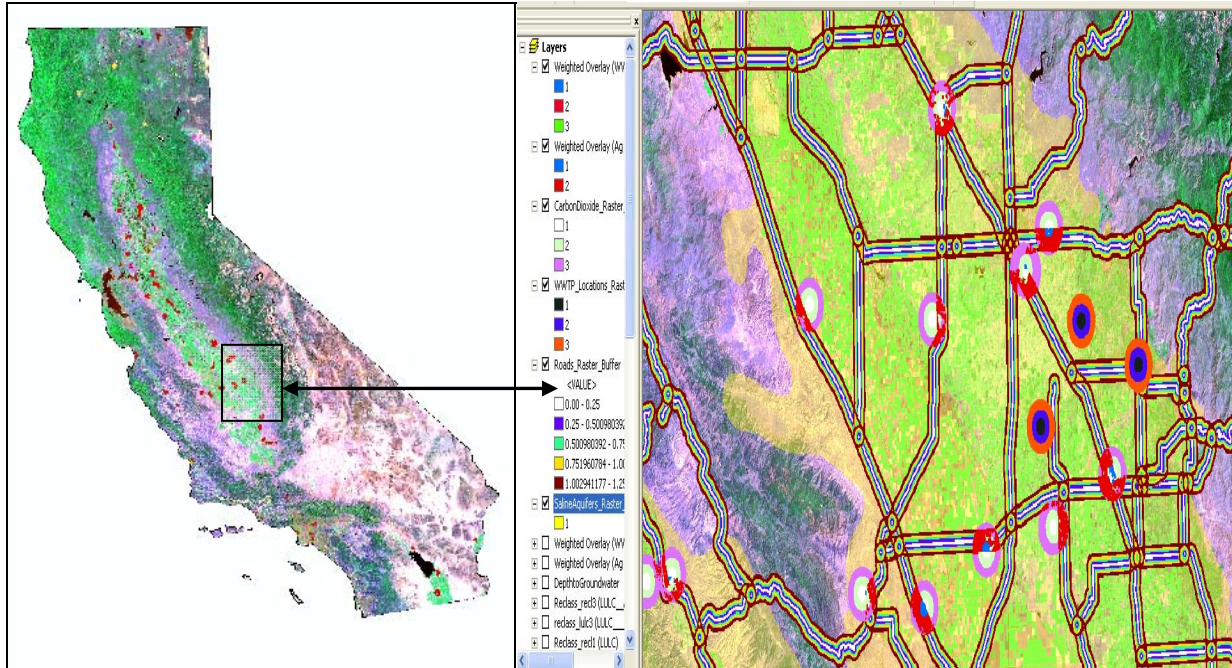

Figure 4.12: Results from a weighted GIS coverage overlay model showing suitable locations. Left : Suggested areas (red polygons) for algae biofuel facilities draped over a Landsat TM image of California. Right: Close -up of California’s San Joaquin Valley with associated GIS coverage layers. Suitable locations are represented by those areas that are colored bright red. Nearby WWTP point data are shown buffered at 3 miles with orange rings.

Climatic factors did not influence the algae production facility siting decisions to any marked degree. This was expected as neither temperature nor solar radiation was heavily weighted in this analysis. For example, solar radiation was not assigned a cost factor, though low solar radiation is certainly one. Also, future techno-economic resource studies, however, will also need to consider a cost breakdown of land use by specific cover type and groundwater production well pumping cost data. However, these results provide an initial framework for analyzing some of the potential resource constraints impacting algae biofuel production.

4.4. ENVIRONMENTAL IMPACTS AND REGULATORY ISSUES

Every potential site where algae biofuels could be produced will have unique characteristics – and thus the environmental impacts to air, soil and water resources will vary. These will also depend on the production technologies, in addition to land, CO₂, nutrient and water inputs.

One important potential environmental impact is the salinity and the chemical constituents in return flows from the algae production system. Evaporation increases pond water salinity, requiring continuous supply of make-up water and disposal of blow-down, which will be concentrated in relation to the input water. Inland this may require further concentration to brines to be injected underground or even dry salts, which may have to be buried (landfilled). Algae facilities located on or close to a coastline could return concentrated brine to the ocean without large expense or significant environmental impact, but would likely fall afoul of environmental laws protecting coastal environments from pollution, even by concentrated seawater. Unless algae biofuel production can be classified as agriculture, it may be difficult to obtain required permits. For example, aquaculture is sometimes classified as an industrial activity and subject to stringent effluent standards. Any discharges to streams and (receiving waters) are more restrictive and must comply with load-based and concentration-based effluent limitations imposed by the federal government and implemented at the same or more stringent level by each State. If a source high in a particular chemical constituent is used as influent to the plant – evaporation from the open algae ponds can potentially result in blowdown return flow concentrations that violate water quality objectives. This is also true of any residual nutrients or algae biomass in the blow-down waters. Environmental monitoring will be an important part of any algae production.

Environmental water quality regulations are determined at the Federal level by the Environmental Protection Agency and implemented by the equivalent State environmental regulatory agency. Section 303(d)(1)(A) of the Clean Water Act requires that “Each State shall identify those waters within its boundaries for which the effluent limitations ... are not stringent enough to implement any water quality standard applicable to such waters.” The Clean Water Act also requires States to establish a priority ranking for waters on the 303(d) list of impaired waters and to establish Total Maximum Daily Loads (TMDLs) for those listed waters. Essentially, a TMDL is a planning and management tool intended to identify, quantify, and control the sources of pollution within a given watershed to the extent that water quality objectives are achieved and the beneficial uses of water are fully protected. A TMDL is defined as the sum of the individual waste load allocations from point sources, load allocations from non-point sources and background loading, plus an appropriate margin of safety. Loading from all

pollutant sources must not exceed the Loading Capacity of a water body, which is the amount of pollutant that a water body can receive without violating Water Quality Objectives.

The specific requirements of a TMDL are described in 40 CFR 130.2 and 130.7, and Section 303(d) of the Clean Water Act, as well as in US Environmental Protection Agency guidance (US EPA 1991). In California, the authority and responsibility to develop TMDLs rests with the Regional Boards. The Environmental Protection Agency (US EPA) has federal oversight authority for the 303(d) program and may approve or disapprove TMDLs developed by the state. If the EPA disapproves a TMDL developed by the state, the EPA is then required to establish a TMDL for the subject water body. In California Central Valley, TMDLs exist for salinity and boron and dissolved oxygen. The San Joaquin River dissolved oxygen TMDL is related to algae loading to the River from upstream sources. Nutrient TMDLs are anticipated in the next 5 years.

Although the algae industry is barely beyond its conceptual stage, it is not too early to consider the environmental regulations that this industry may have to face five or ten years from now. The Algal Biomass Association (ABO) has convened a workgroup to develop guidelines for anticipated future environmental regulation of the algae biofuel industry. Since there are no current environmental laws regulating algae biofuel production per se, the ABO is being proactive to work cooperatively with legislators and regulators to develop sensible guidelines, regulations and legislation that will both protect the environment and not limit this nascent industry. Such regulations also need to address matters such as the use of genetically modified algae (GMAs), and use of “non-native” algae strains (if indeed a distinction can be made between “native” algae and imported strains).

CHAPTER 5: ENGINEERING DESIGNS AND COST ESTIMATES

5.1 CONCEPT AND ASSUMPTIONS

The main objective of this study is to determine plausible, realistic costs of algae biofuels production using currently available engineering designs and practices and projected near- to mid-term algae biomass cultivation, harvesting and processing technologies. The fundamental basis for any such study is that algae biofuel production requires low-cost cultivation systems, for the resulting biofuel to be cost competitive with alternative biofuels and other renewable energy sources. For this reason, open ponds, rather than closed photobioreactors were selected as the main cultivation systems for the purpose of design and cost estimation.

This chapter describes the design, construction, operations, and estimated costs of algae biofuel facilities that use paddle wheel-mixed raceway ponds (“high rate ponds”)—as do most commercial microalgae production systems and some microalgae-based wastewater treatment systems. Processing of the algae biomass is accomplished with solvent extraction to recover oil and anaerobic digestion of extraction residual to recover biogas. In some cases, raw algae biomass is anaerobically digested and oil production is omitted, for comparison purposes.

The major differences between existing commercial systems for algae biomass production and the designs described herein are the following:

- An order of magnitude larger size for the individual growth ponds and the overall facility (i.e., individual growth ponds of 4 ha (10 acres) and facilities of 100 ha to 400 ha);
- The use of alternative sources of CO₂ (e.g., flue gases, wastes) and nutrients (wastes);
- The assumption that a reliable bioflocculation harvesting process can be developed, allowing the use of settling ponds for an initial harvesting step that provides a 30- to 50-fold concentration factor;
- The use of local clay to line the ponds, avoiding the high cost of plastic liners; and
- The assumption of high biomass productivity and lipid content by selected and genetically improved algae strains (e.g. an annual average of 20 g/m²-day of *harvested* biomass productivity containing 25% *extractable* oils, in the form of triglycerides).

These primary assumptions are generally similar to those used in prior techno-economic analyses of algae biofuel production, starting with the work of Oswald and Golueke (1960) and followed by more detailed studies based on advances in algae mass cultivation technologies over the past 50 years (Benemann et al., 1977, 1978, 1982; Weissman and Goebel, 1987; Benemann and Oswald 1996; already discussed in Chapters 2 and 3). Other more recent

techno-economic analyses are, in part, derivative of those cited above, deal with closed photobioreactors, or are either not published and/or lack detail, and thus are not considered in the present study.

The main advance of the present study over the prior ones mentioned above is the greater level of detail provided in many design aspects, as well completely new and up-to-date construction cost estimates. Another major difference is the use of municipal wastewaters (as proposed by Oswald and Golueke, 1960; see also Benemann et al., 1977) either to make-up water and nutrient losses or to accomplish wastewater treatment with biofuels produced as a byproduct.

In the climates most suitable for algae production, evaporation exceeds rainfall, and blowdown to limit salt build-up is needed, as discussed in prior sections. Blowdown will also decrease the concentration of biological factors that might build-up in concentration, affecting growth rate. Facilities using brackish or saline waters will have greater blowdown needs than the wastewater-based systems of this chapter. Of course, fresh, brackish or seawater systems would all grow different algae species, but the actual algae species to be cultivated, and any additional specific requirements that these may have, are not considered herein. We assume that the algae cultivated will have been specifically developed for the purpose at hand and can be maintained through relatively frequent inoculation as essentially uni-algal cultures in the open ponds. This assumption has merit in that commercial production of *Chlorella* and *Haematococcus* algae relies successfully on frequent inoculation of the main growth ponds.

Closed photobioreactors (PBRs), such as tubular bag or panel designs, will play an important role in algae biofuel systems as a means to produce the initial starter inoculum (seed culture), but they would comprise only a small fraction of the overall growth area, typically only 0.1% of the total production area, due to their inherently high costs, both capital and operating (see Chapter 2). Although some reports claim low-cost PBRs, this is not supported by either detailed analysis or experience. Therefore, the designs for larger-scale algae inoculum production in the present study include covered ponds (essentially plastic hoop greenhouses, covering ~1% of the total pond area) and open plastic-lined ponds (covering ~10% of the total area). Plastic-lined ponds are advantageous in that they are possible to clean, which should decrease the rate of culture contamination. These higher cost units would provide large amounts of seed culture (inoculum) at a modest (<5%) overall increase in capital and operating expense.

Although paddle wheel mixing is the mixing method of choice in most current commercial systems, that is not an essential design element, and alternative mixing systems can, and have been, considered. For example, impeller mixing (as proposed by Oswald and Golueke, 1960), air-lift mixing (used extensively in aquaculture systems), jet mixers, etc. However, none of these appear to provide any major advantages over paddle wheels in terms of flexibility of operations, capital costs and, most importantly, operating energy inputs, which mainly dictated

by mixing velocity, not mixing device, and which must be kept below 30 cm/sec to avoid excessive energy use.

5.2 DESCRIPTION OF THE FIVE FACILITY CASES

This chapter describes five conceptual “cases” for algae pond biofuel production facilities (Table 5.1) and the cost estimates for construction, operation & maintenance, and financing for these facilities. The first four cases are relatively modest in size (100 ha, 250 acres), while the fifth case is larger (400 ha, 1,000 acre). These facilities are envisioned as being in regional networks that each share a centralized oil extraction facility.

Table 5.1: The five general case studies considered in this report

	Pond Area (ha)	Emphasis	Biofuel Product	Operation Schedule
Case 1.	100	Wastewater Treatment	Oil	year round
Case 2.	100	Wastewater Treatment	Biogas	year round
Case 3.	100	Biofuel	Oil	10 mo./yr
Case 4.	100	Biofuel	Biogas	8 mo./yr
Case 5.	400	Biofuel	Oil	10 mo./yr

(Note: The cases with the biofuel emphasis recycle water, nutrients, and carbon to the maximum extent in order to expand the algae production for the given water and nutrient inputs. The wastewater treatment-emphasis cases discharge a treated water effluent throughout the year, with recycling of water, nutrients, and carbon only during the peak summer algae growing season. The wastewater treatment-emphasis cases receive higher wastewater treatment revenues than the biofuel-emphasis cases.)

In the current study, all cases use municipal wastewater as the source of all water and nutrient inputs, and most of the carbon input. Cases 1 and 2 emphasize wastewater treatment, with minimal water recycling, and Cases 3 to 5 emphasize biofuel production, with maximum recycling of water and nutrients, which allows more fuel production per unit input of water and nutrients. Both types of facilities produce both biofuels and treated wastewater, but there is a different emphasis between these two outputs. Although not specifically considered herein, Case 5-type facilities could operate independently of wastewater inputs by using agricultural fertilizers; power plant flue gas or other sources of CO₂; and fresh, brackish, or saline waters, as available at a particular location, and are thus generic algae biofuels production processes.

Within the categories of wastewater-emphasis (Case 1 and 2) or biofuel-emphasis (Cases 3 to 5), the facilities are designed to produce either oil plus biogas or only biogas, with the biogas converted to electricity and waste heat. The electricity is used onsite and some is exported, the

amount depending on season and particular case. The waste heat from the power plant is used for biogas digester heating.

The biogas-only production facilities avoid the costs of biomass drying and algae oil extraction. The oil production cases also use anaerobic digestion for biogas production, but here the main purpose of digestion is treatment and, for Cases 3 to 5, recycling of the residues remaining after oil extraction. To assess economies-of-scale for the algae biomass and oil production, Case 3 with 100 ha of ponds can be compared to Case 5, the 400-ha facility.

5.3 LOCATION AND SITE DESCRIPTIONS

To provide an analysis that realistically considers the many siting criteria that affect algae production facilities, a specific region was selected for the facility designs. The location selected for the case studies was southern California, 100 miles east of San Diego in the Imperial Valley, southeast of the Salton Sea (Figure 5.1). This region of abundant flat land has been the site of many aquaculture facilities and of the only major microalgae farms in the contiguous US: a currently-operational *Spirulina* farm (Earthrise Nutritionals, LLC) and a former *Dunaliella* farm (operated first by MicroBio Resources, Inc., during 1980-1990, then briefly by Amway/Nutriline, in the early 1990s, and recently re-started as a test facility for algae biofuels and aquafeed production by Carbon Capture Corporation). The present designs are almost order-of-magnitude larger in terms of individual pond size and overall scale than the existing Earthrise facility.

Algae farming in this area benefits from high insolation (annual average daily insolation of 6 kWh/m²-day) (Figure 5.2) and mild winters (average 24-hr air temperature is 12.3°C in December and January) (CIMIS, 2010). However, night time temperatures are relatively low, and this may become an issue with algae production at this site. Also, the desert climate leads to high annual evaporation (Figure 5.3), with a peak monthly evaporation averaging 1 cm/day or 10,000 m³/day for a 100-ha facility. To avoid excessive salt accumulation in the biofuel-emphasis cases, some blowdown is required. This blowdown can be modest in volume if the steady state salinity is allowed to be high. However, blowdown disposal is not considered specifically in this analysis. It is assumed to be discharged into the Salton Sea, as is currently done with other agricultural drainage waters.

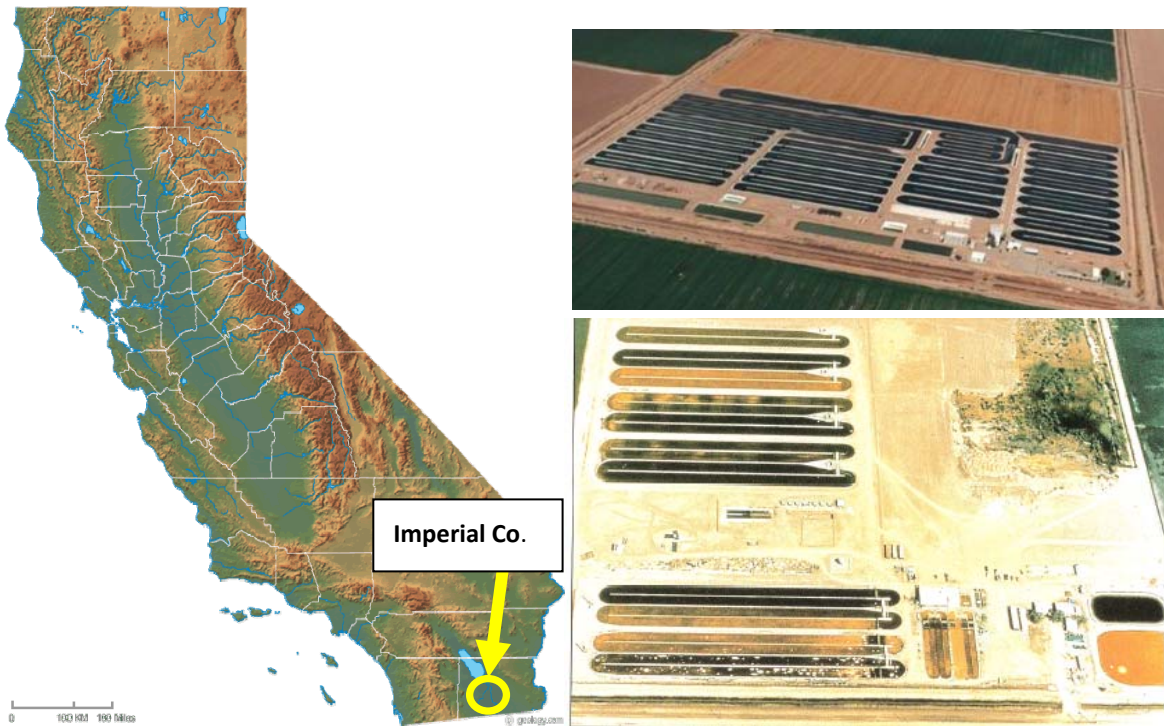

Figure 5.1: Proposed location for algae facilities in California and photographs of two algae production facilities in this area.

Top: *Spirulina* farm (Earthrise Nutritionals). Bottom: *Dunaliella* farm, (Microbio Resources, ca. 1990, now owned by Carbon Capture Corp.). (Map: www.geology.com).

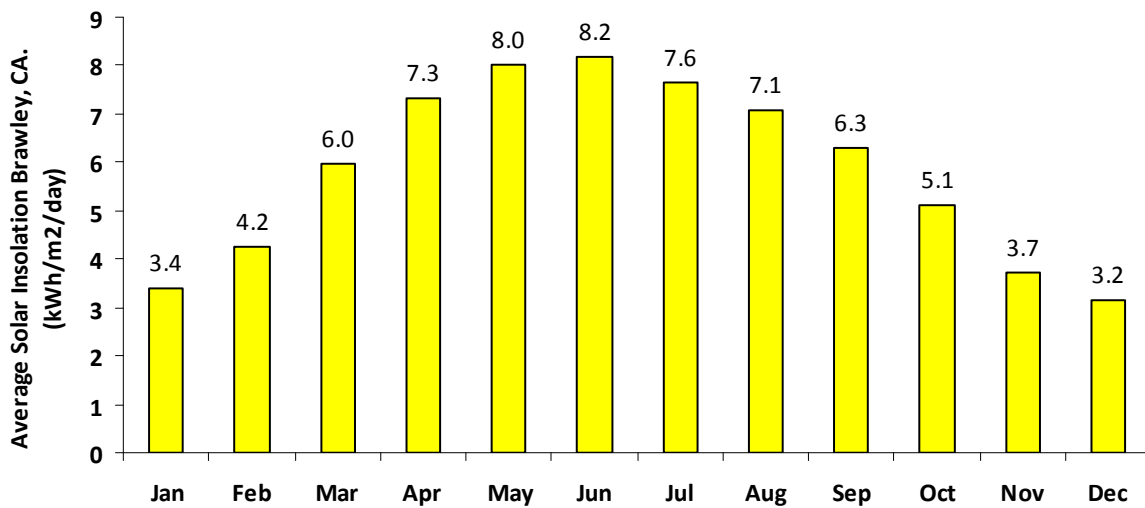

Figure 5.2: Average insolation per 24-hr day at Brawley, Imperial County, California (CIMIS Station 128, 1995-2009)

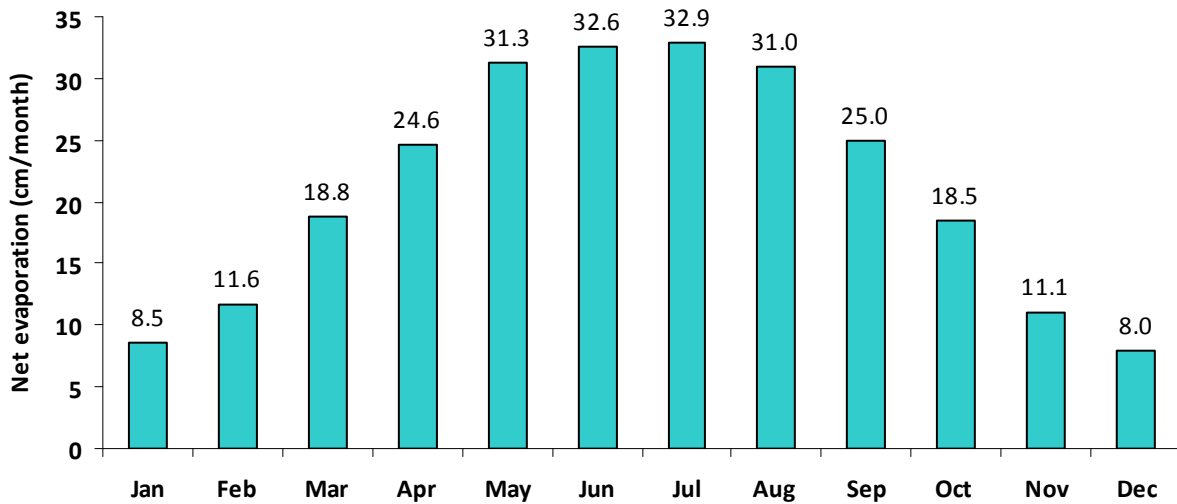

Figure 5.3: Net monthly evaporation for Imperial County (US Bureau of Reclamation, 2004)

To eliminate the cost of lining with plastic geomembrane, the ponds must be lined with native clay soils, and the Imperial Valley is rich in clay deposits. The suitability of sites for clay-lined ponds has been assessed by the US Department of Agriculture in the context of waste lagoon siting (USDA, 2009). According to the USDA, 35% of the Imperial Valley (~14,000 ha) has been classified as having "No limitations" with regards to wastewater lagoon construction (Figure 5.4). The criteria for "No Limitations" are a high clay content in the soil (39%) and flat topography. (The cost of high density polyethylene lining and compacted clay lining are compared later in this Section). It should be further noted that algae wastewater ponds have been observed to be self-sealing and thus even lower clay content soils are likely suitable for such systems, where regulations allow.

The facilities designs assumed the availability of relatively large amounts of domestic (municipal) wastewaters (51,700-235,000 person equivalents), although other wastewater sources (e.g., animal farm flush waters, agricultural drainage, and aquacultural wastewater) would also be suitable sources of nutrients and water with relatively minor modification of the designs. Algae production has been proposed as a method for nutrient removal from agricultural drainage waters prior to discharge (Benemann et al., 2003; Lundquist et al., 2004), and nutrient-contaminated river waters (New or Alamo Rivers) could also be considered. For domestic wastewater flows in the Imperial Valley, three cities could provide substantial flows for the facility designs presented: Brawley (pop. 23,000), El Centro (pop. 40,000) and Calexico (pop. 38,000). However, the present study does not specify a site or wastewater source but instead uses the Imperial Valley as an example of a region suitable for algae production.

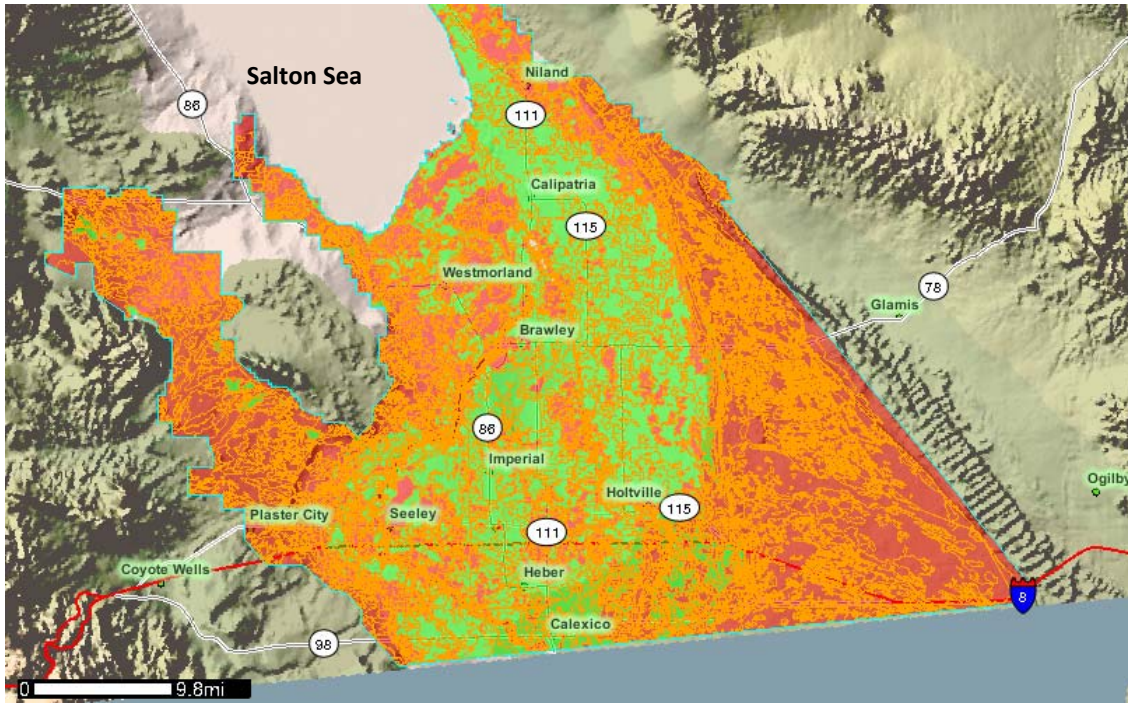

Figure 5.4: Green areas indicate where in Imperial County the soils have enough clay content to allow them to be used as wastewater lagoon lining material (USDA, 2009).

5.4 ALGAE CULTIVATION AND FUEL YIELD ASSUMPTIONS

The productivity assumptions used in this report are not based on specific long-term experimental data but on the judgment, experience, and extrapolations of prior work by the authors and many others. In this report, we assume an annual average productivity of 22 g/m²-d and 25% extractable oil (triglycerides) content in the biomass. These values are our best estimate for the selected region that could be plausibly accomplished with a moderate amount of additional R&D work (~5 years). Similar values have been reported for small scale-systems at the Seambiotic seawater pre-pilot plant in Israel, for which annual production rates and lipid contents of about 20 g/m²-d and 25% have been recently reported for a small pilot plant for several algae species (Ben Amotz, 2009). The prospects for further improvements are discussed shortly.

The monthly assumed daily productivities for the study area are summarized in Figure 5.5, giving an annual average of 22 g/m²-day (80 mt/ha-yr), with a maximum-month productivity of nearly twice this (38 g/m²-day) and a minimum-month productivity of only 4 g/m²-day. (All productivities are on an ash-free dry weight organic matter basis.) The almost ten-fold variation between highest and lowest productivity is one of the major challenges in the design

of the proposed process. However, it should be noted that future research may not only increase total productivity and lipid content but could also increase relative productivity during the colder months. This is the major long-term R&D objective in this field.

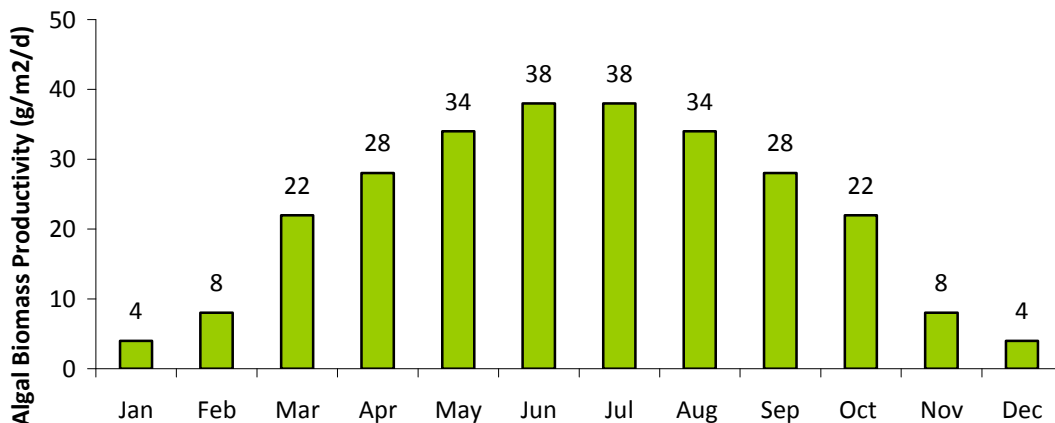

Figure 5.5: Assumed daily areal biomass productivity on a monthly average basis.

Note: Before harvesting and thickening losses

One barrier to consistent high algae production is zooplankton grazing, one of the major algae production problems that needs to be overcome. We assume that invasion by weed algae (lower productivity but more competitive), can be overcome with provision of large amounts of seed cultures and frequent culture re-starts. In the longer-term, a further 50% increase in both productivity and lipid content may well be possible through the development of genetically improved algae strains with the following characteristics (see discussion in Section 2):

- i. They exhibit a greatly reduced light saturation effect (e.g., Huesemann et al., 2009),
- ii. They produce triglycerides constitutively (i.e., not induced by nutrient limitation), and
- iii. They have higher productivities at lower temperatures than currently used strains.

However, we did not include such longer-range productivity projections in our cost analysis. In contrast, the techno-economic study of Benemann and Oswald (1996) projected much higher productivities and oil content, and even analyzed the process design and economics for the maximum theoretical solar conversion efficiency case. Others (Huntley and Redalje, 2007, for example only) have also projected near-theoretical annual average productivities (e.g., 50 g/m²-day for Hawaii). We have not reviewed here the field of projected productivities but have elected to carry-out the present study with the more conservative, but still quite optimistic, estimates given above. We consider these estimates to be plausibly achievable in the near- to mid-term (~5 years) assuming steady but significant R&D progress over current technology, but without a major, unpredictable technology breakthrough.

With provision of sufficient CO₂ and other nutrients (N, P, etc.), light and temperature are the two main factors limiting algae biomass productivity. The combined effect of these parameters is poorly understood at present, but we believe the above productivity assumptions represent a reasonably realistic case for near- to mid-term algae production near the Salton Sea.

At this location, the greatest factor determining the monthly variation in productivity was temperature, in particular low night-time temperatures in winter. Winter insolation in southern California is still rather high, but excessive night cooling can prevent the ponds from reaching the warm temperatures needed for high productivity during the day. Thus, productivity does not reach the levels to be expected based just on insolation. In fact, if insolation were the main factor, and after considering the light saturation effect (see Chapter 2), the monthly average in winter months of December and January would have been about three-fold higher than shown in Figure 5.5. Eventually, it may be possible to develop algae strains able to take advantage of the insolation, despite the lower temperatures. However, that assumption was not made in this study.

In the current analysis, for the Cases 3 to 5 primarily operated for biofuel production (as opposed to wastewater treatment), it is assumed that operation will cease during winter months when productivity would be too low to justify their operating costs or net energy output. It should be noted that commercial *Spirulina* production in the Imperial Valley achieves productivities of only about half that used in this report, and shuts down for almost half the year. However, such low annual productivity and short production season is due mainly to the cold-sensitivity of *Spirulina* (a cyanobacterium, and not an oil producer). In any event, the assumed long-term productivity and oil content of the algae biomass must be proven through strain development and pilot testing in specific climatic regions.

Peak algae productivity controls the sizing of much of the infrastructure in the facility designs. Daily maximum biomass productivities were used to determine the size of components such as the high-rate pond piping and the harvesting units. A daily maximum productivity of 38 g/m²-day was chosen for peak summer months (Figure 5.5). In addition to the monthly average, an hourly maximum productivity of 4 g/m²-hr was chosen (Figure 5.6), which determined the CO₂ supply (flue gas) delivery infrastructure.

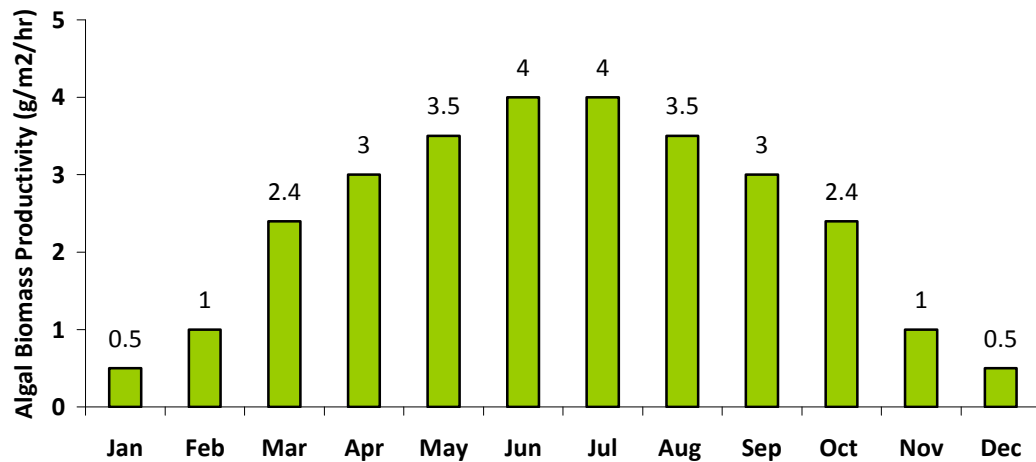

Figure 5.6: Assumed maximum hourly algae biomass productivities in each month

Since growth rates (not synonymous with productivity, it should be noted) decline in winter, the hydraulic residence time (HRT) in the HRPs must be increased to maintain a stable culture and prevent cell washout. The HRT of the HRPs are adjusted from 3 days in summer to 5 days in winter for all cases in this report (Table 5.2). It should be noted that these are idealized: in practice slightly shorter and longer hydraulic retention times may be required in summer and winter, respectively, for maximum productivity.

Hydraulic residence time sets the standing biomass (in terms of g/m^2), while pond depth influences the resulting algae cell concentrations (g/L). For the present study, the depth of the HRPs was set at 30 cm, based on prior analysis and experience. Depths shallower than 30 cm limit the size (area) of individual ponds due to pond hydraulics, CO_2 outgassing, and CO_2 storage, and also exhibit greater diel temperature fluctuations. Depths much greater than 30 cm have the disadvantages of more water handling during the initial harvesting step, but can improve the temperature regime that the algae experience, improve CO_2 storage, etc.

Numerous other assumptions were required to develop the case study designs and associated costs estimates. These assumptions are described in the relevant sections below. As an example: for the 100-ha wastewater-emphasis facilities (Cases 1 and 2), the wastewater flow that must be supplied, assuming a 30-cm deep pond, is constant at 62 million liters per day (MLD). This flow results in a 5-day hydraulic retention time in winter, and, with partial recirculation of harvest water, a 3-day retention time is also achievable in summer. The recirculation provides enough water, during high insolation, to allow for both the pond depth and short hydraulic retention time required to maximize productivity during these periods. The

flow of 62 MLD would be produced by a population of about 235,000. For the 100-ha biofuel-emphasis facilities (Cases 3 and 4), only 5 to 14 MLD (1.4 to 3.6 million gallons per day (MGD)) of wastewater are needed to make-up for water losses, mainly due to evaporation. (The blowdown requirement is 22% of the influent a relatively small fraction of the evaporative losses). Case 5 requires make-up water flows due to evaporation ranging from 23 to 59 MLD (Table 5.2).

Table 5.2: Hydraulic retention times and influent flows for each case.
Note: make-up water is that required to compensate for losses due to evaporation, blowdown, and biomass processing.

	Hydraulic Retention Time, HRT (days)			Make-up water added (MLD)		
	Summer	Spring/Fall	Winter	Summer	Spring/Fall	Winter
Case 1.	3	4	5	62	62	62
Case 2.	3	4	5	62	62	62
Case 3.	3	4	5	15	11	6
Case 4.	3	4	5	15	11	6
Case 5.	3	4	5	59	45	23

Note that for all cases the same productivity assumption is made, of 22 g/m²-day (80 mt/ha-yr) annual average productivity and the same monthly and maximum hourly productivity variations noted above. The only productivity difference is that, in Cases 1, 3 and 5, the biomass produced is assumed to contain 25% extractable triglycerides. Thus, for these cases, the biomass has a higher energy content (and therefore an about 10% higher solar conversion efficiency) than the biomass produced in Cases 2 and 4. In these latter cases, the biomass is digested to methane with a yield typical of low-lipid algae, as discussed later.

For all cases, after cell separation, the liquid medium is recycled, at least in part, back to the algae growth ponds. Medium recycle is extensive in cases 3 to 5, to the maximum possible at least in summer, but only as much as required for complete nutrient removal, the key process parameter, in the wastewater treatment emphasis Cases 1 and 2. However, such recycling may select for non-settling algae strains, and this will need to be guarded against by adjusting pond operations, such as by quarterly or even monthly culture restarts, occasional sand filtration of the effluents, some recycle of settled algae, etc. The actual operating conditions will need to be developed during future work as applicable to particular algae species and strains, sites and processes, and are not further considered here.

A critical difference in all these cases is the carbon balance. Carbon for algae growth comes from the following main sources:

- i. Carbon released during oxidation of wastewater organic matter in the growth ponds
- ii. Inorganic carbon in the wastewater influent
- iii. Flue gas CO₂ from combustion of biogas derived from the primary sludge
- iv. Flue gas CO₂ from combustion of biogas derived from the algae biomass digestion
- v. Digester effluent from digestion of primary sludge
- vi. Digester effluent from digestion of the algae biomass or of residue after oil extraction
- vii. Exogenous sources of carbon, such as flue gas from nearby power plant or other sources

For the wastewater treatment Cases 1 and 2, carbon for algae growth is supplied from all the sources listed. For Cases 3, 4, and 5, primary sedimentation is omitted and thus carbon sources iii and v are omitted. For all cases in this study, absorption of atmospheric CO₂ is assumed negligible, and the exogenous carbon source (vii) is flue gas from off-site natural gas combustion such as in a power plant. (A detailed mass balance for Case 5 is discussed later, and shown in Figure 5.29). Note that in the above list air CO₂ is not considered, as the ponds would at all times be oversaturated in regards to CO₂ and thus loose rather than absorb CO₂.

5.5 HIGH-RATE POND LAYOUT, CO₂ DELIVERY AND CONSTRUCTION

5.5.1 GENERAL HRP DESIGN CONSIDERATIONS

The basic design is that adopted in prior studies (Benemann et al., 1982; Weissman and Goebel, 1987; Benemann and Oswald, 1996): a single loop HRP raceway design (Figure 5.7 and Figure 5.8). This was selected over serpentine channel geometries to minimize excess head loss during flow around the bends and to provide a simpler, less costly design to construct. In any case, the decision of single loop vs. serpentine channels would not have a major effect on overall costs.

Identical HRPs comprise each facility. For individual ponds, the length-to-width ratio of the channel affects cost, with narrow channels being more costly due to the greater need for pond perimeter construction materials and wider channels being more costly due to the wider paddle wheels and carbonation stations. Also, excessively wide channels will likely to lead to meandering flow patterns, increased wind influence, and algae sedimentation within the unmixed zones. The 30-m channel width chosen for this study is approximately 10-m wider than the widest known operational pond, but this was considered a reasonable extension of experience. Channels of 30-m width are about twice as wide as the largest algae biofuel production HRPs currently in operation, in New Zealand (see Section 3.2.1.)

Since each pond needs a paddle wheel mixer and other appurtenances, the area of each pond should be as large as possible for economy of scale. However, channel length is limited by the need to recarbonate (i.e., supply CO₂) the culture, which in summer at peak productivity imposes a scale limit. Length is also limited by the lift required to overcome the head loss of flow around the channel circuit, considering a standard water depth of 30-cm. The maximum

reasonable water lift by paddle wheels leads to a maximum circuit length of about 1400 m. The corresponding dimensions of the individual ponds selected is 60-m wide by 690-m long, and the resulting area of each pond is 4 ha (Figure 5.7). Figure 5.8 and 5.9 show details of the pond construction. Some details that do not significantly affect costs, such as the placement of the flow deflectors, are omitted.

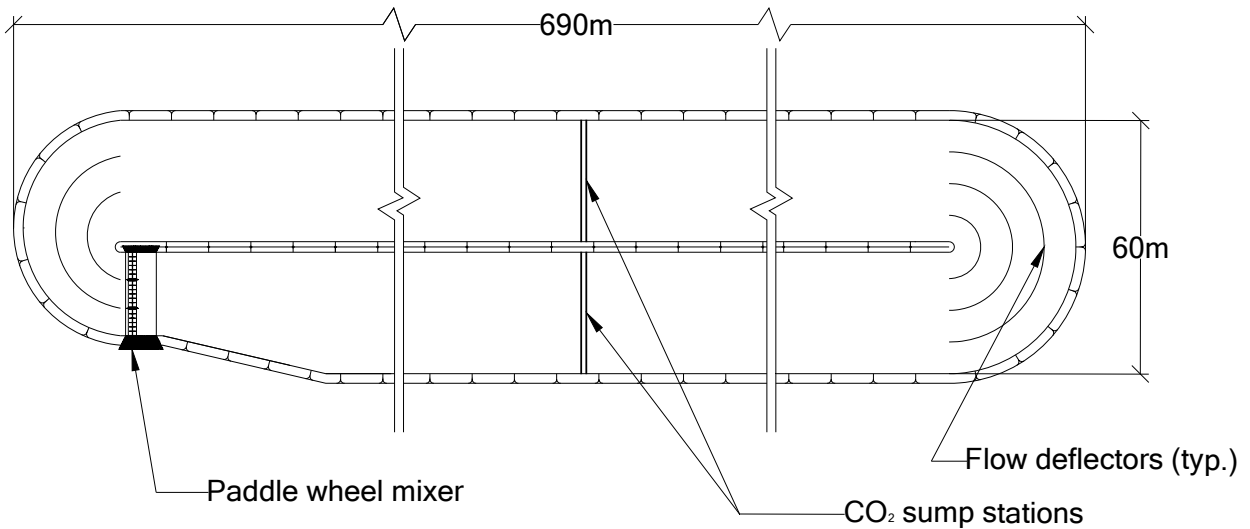

Figure 5.7: Plan view of an individual 4-ha high rate pond.

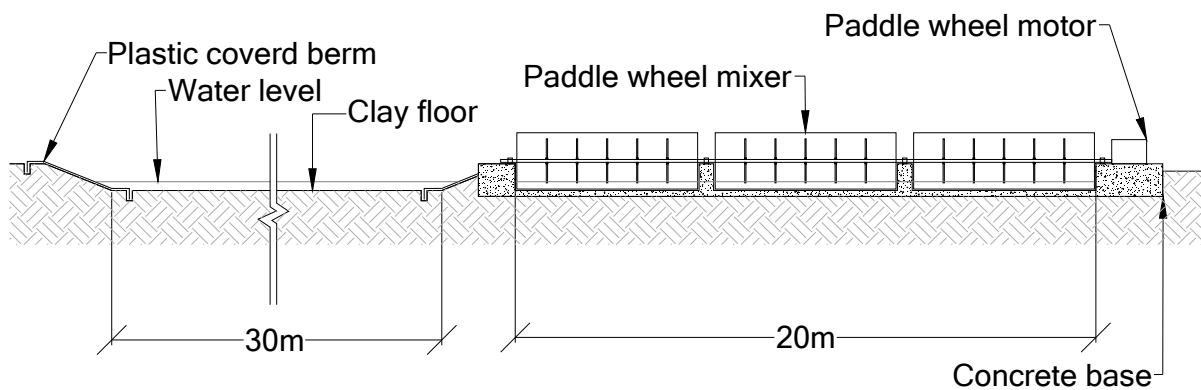

Figure 5.8: Section view of a 4-ha high rate pond through paddle wheel station.

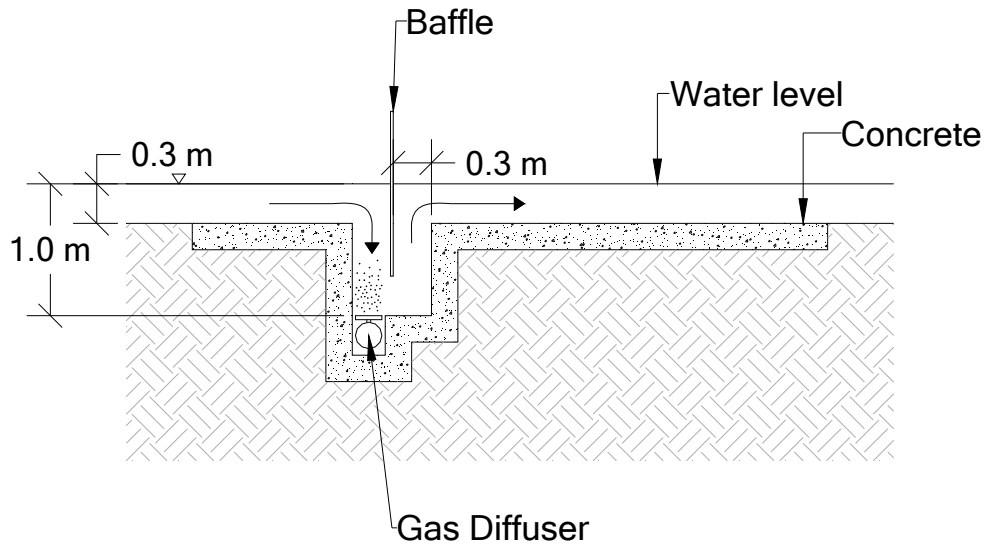

Figure 5.9: Counter current sump for flue-gas transfer to algae ponds

The power required to mix the ponds is a major parasitic loss in the algae fuel production system. With power use increasing by the cube of the flow velocity (Figure 5.10), a mixing velocity of between 0.20 to 0.25 m/s is about the maximum that should be used on average, with only occasional, brief, periods of higher velocities, as needed to supply CO₂ to the ponds and to keep the algae cells in suspension (which would depend on the extent of flocculation).

Mixing head losses accrue from flow around the 180° bends at both ends of the pond, flow through the two counter-current carbonation sumps, and, most importantly, from the friction of the bottom of the pond. Friction from the side walls of the shallow pond is negligible. The head loss was estimated using Manning's equation as described below.

The mixing energy required for the HRPs is calculated using Manning's equation as for other open channels according to which the head loss that occurs as water flows around a 180° bend can be estimated as:

$$h_b = \frac{Kv^2}{2g}$$

where h_b = headloss in the bend (m)

v = the mean velocity (m/s)

g = the acceleration of gravity, 9.81 m/s²

K = kinetic loss coefficient for 180° bends (theoretically = 2)

With a channel velocity of 0.25 m/s, head loss in the bends is:

$$h_b = \frac{2(0.25 \text{ m/s})^2}{2(9.81 \text{ m/s}^2)} = 0.0064 \text{ m}$$

With two 180° bends per circuit $h_b = 0.0127 \text{ m}$. This equation was also used to determine head loss through the two carbonation sumps in each pond, with the result of $h_s = 0.0255 \text{ m}$.

Friction loss that occurs along the length of the raceway is estimated with Manning's equation:

$$h_c = v^2 n^2 \left(\frac{L}{R^{4/3}} \right)$$

where: h_c = channel straightway headloss (m)

n = roughness factor (Manning's n) = 0.018 for clay channels (Hudson, 1993)

R = channel hydraulic radius (m)

L = channel length (m)

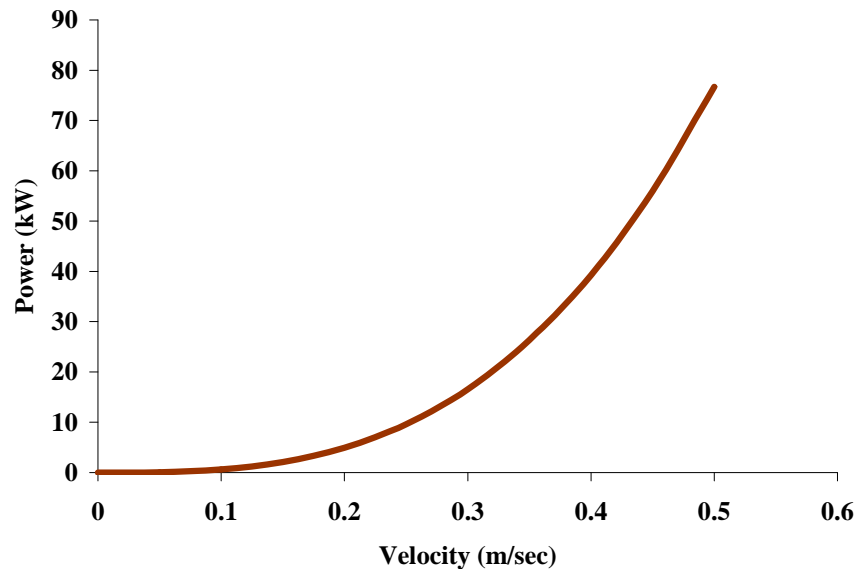

Figure 5.10: Energy consumption to overcome head losses from friction along the length of the channels, the 180° bends and two sumps, as a function of flow velocity for a 4-ha pond.

With a cross sectional area of 9.2 m^2 and a wetted perimeter of 31.6 m , the hydraulic radius is equal to 0.29 m . With a total straight channel length of 1260 m , head loss equals the following:

$$h_c = (0.25 \text{ m/s})^2 (0.018)^2 \left(\frac{1260 \text{ m}}{0.29 \text{ m}^{4/3}} \right) = 0.1318 \text{ m}$$

Summing the head losses around the bends, through the sumps, and down the straightaways, the total head loss is:

$$h = h_b + h_s + h_c$$

$$h = 0.0127 \text{ m} + 0.0255 \text{ m} + 0.1318 \text{ m}$$

$$h = 0.1701 \text{ m}$$

This head loss calculation ignores head losses caused by the rising bubbles in the carbonation sumps and any net drag caused by wind. The calculated 0.170 m of head loss implies only a 0.13 m of water depth on the upstream side of the paddle (for a 30 cm design depth). If that depth is not sufficient for efficient paddle wheel lifting, the paddle wheels may be constructed in slightly submerged zones (as was already proposed in earlier studies). Further the use of laser guided equipment would allow some slope to be built into the raceways, reducing the depth differences on the two sides of the paddle wheel, though it would limit mixing in one direction only.

The power required to overcome the total head loss is given by the equation:

$$W = 9.80 \left(\frac{Qwh}{e} \right)$$

where,

W = power required (W)

Q = channel flow (m^3/s)

w = unit mass of water, $998 \text{ kg}/\text{m}^3$ at 20°C

h = total head loss (m)

e = paddle wheel and drive system efficiency (40% assumed)

9.80 = conversion factor in $\text{W}\cdot\text{s}/\text{kg}\cdot\text{m}$

Considering the sloped sides of the ponds, the flow is $2.31 \text{ m}^3/\text{s}$. Therefore, power use is:

$$W = 9.80 \frac{\text{W}\cdot\text{s}}{\text{kg}\cdot\text{m}} \left(\frac{(2.31 \text{ m}^3/\text{s})(998 \text{ kg}/\text{m}^3)(0.1701 \text{ m})}{0.4} \right) = 9,590 \text{ Watts}$$

And with a total of 25 ponds, all running 24 hrs/day, the total energy consumption is the following:

$$\text{Energy} = (25 \text{ ponds})(24 \text{ hrs}/\text{d}) \left(\frac{9,590 \text{ watts}}{1000 \text{ watts}/\text{kilowatt}} \right) = 5,754 \text{ kWh}/\text{day}$$

This is a significant power consumption, about 2.4 kW per hectare. However, the mixing velocity can be slowed at night and during periods of lower productivity to reduce energy consumption. The assumption is that the ponds will operate for 14 hours at maximum speed (0.25 m/s) and 10 hours at a reduced 0.20 m/s, thereby reducing the energy consumption for all the ponds from 5,754 kWh/d to 4,770 kWh/d. On an annual average, however, this could be reduced further as only during periods of highest productivity would the higher mixing velocity be required. To be conservative, we will ignore the fact that slower mixing speeds could be used at certain times and use the calculated energy consumption of 4,770 kWh/d (or 2.0 kW/ha). However, this does not consider any additional energy required to overcome the effect of the countercurrent carbonation system (see further below).

It should be also noted that one of the major purposes often indicated in the literature for algae pond mixing is to bring the algae in and out of the light zone, thus improving distribution of light to the cells, for optimal photosynthesis. However, it has been shown in controlled experiments that mixing does not necessarily increase productivity (Weissman et al., 1988). Instead, high mixing intensities will result in greater outgassing of CO₂, and thus loss of this vital nutrient, and reduction in the maximum scale of the ponds. It will also increase O₂ outgassing and thus reduce O₂ tensions, which is beneficial to many algae. Reduced O₂ tensions are a possible cause of the improved productivities reported in the literature under higher mixing regimes. The “flashing light effect,” in which millisecond light flashes increase productivity, is not applicable to algae mass cultivation, as the power densities involved would be enormous (see Chapter 2).

Layout of the ponds in an east-west orientation will reduce shading (though not a major effect for such large ponds with a modest freeboard). The other operations, such as pretreatment and solids handling, were placed in the middle of the facility to allow for efficient distribution and receiving of materials (Figure 5.11 and Figure 5.12). The HRPs are designed to be constructed by grading and laser leveling the raceways to create earthen berms with slopes of 2.5:1 and a total height of 0.9 m around the entire perimeter of each pond. The center divider is constructed similarly but with a narrower berm to save construction costs compared to vertical divider walls (e.g., of concrete blocks). With a water depth of only 0.3 m, the 0.6 m of freeboard provides protection from accidentally overflow or wind-driven waves, per likely regulatory requirements when dealing with wastewaters. If the process did not treat or use wastewater, a lower berm height could be considered, at some modest cost-savings.

To construct these ponds, dozers are used on the berms, which are laid down in 6-inch lifts and compacted. Dirt pans of 15-cubic yard size are used to do initial leveling, and the site is finished by tri-planing, which will smooth any “duck walking” (shimming) marks created by the dirt pan equipment. These are all common implements used in the Yuma, Arizona area where level field

irrigation is the norm (E. Hale, pers. comm., 2009). Earthwork unit cost estimates were obtained from two contractors, and details are included in the cost analysis below.

Inoculation ponds are built with plastic liner with a total area of 1% of the production ponds, or 10,000 m² for the 100-ha system. Ten individual inoculation ponds, each with an area of 1000 m², have a scaled down version of the high rate ponds described above with individual paddle wheels. One important difference is that the inoculation ponds will be covered with a plastic greenhouse shelter to extend the growing season and to provide more protection from contamination from non-desired algae. The cost of these inoculation systems is included in the overall cost estimates.

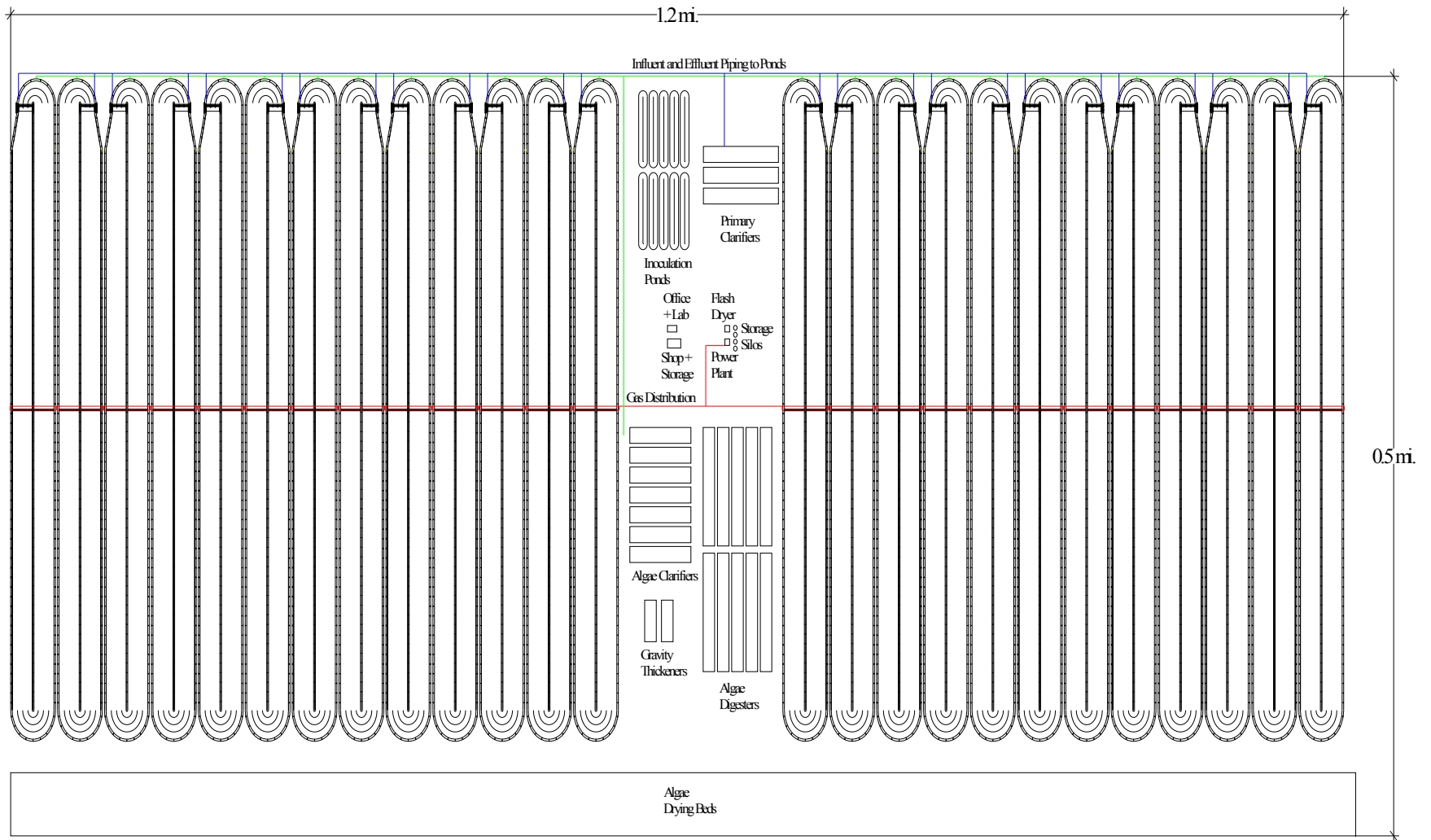

Figure 5.11: Case 1 site layout showing 100-ha of high rate algae ponds, drying beds, and dry algae storage silos .

Note: the algae drying beds and silos do not apply to the biogas only Cases 2 and 4.

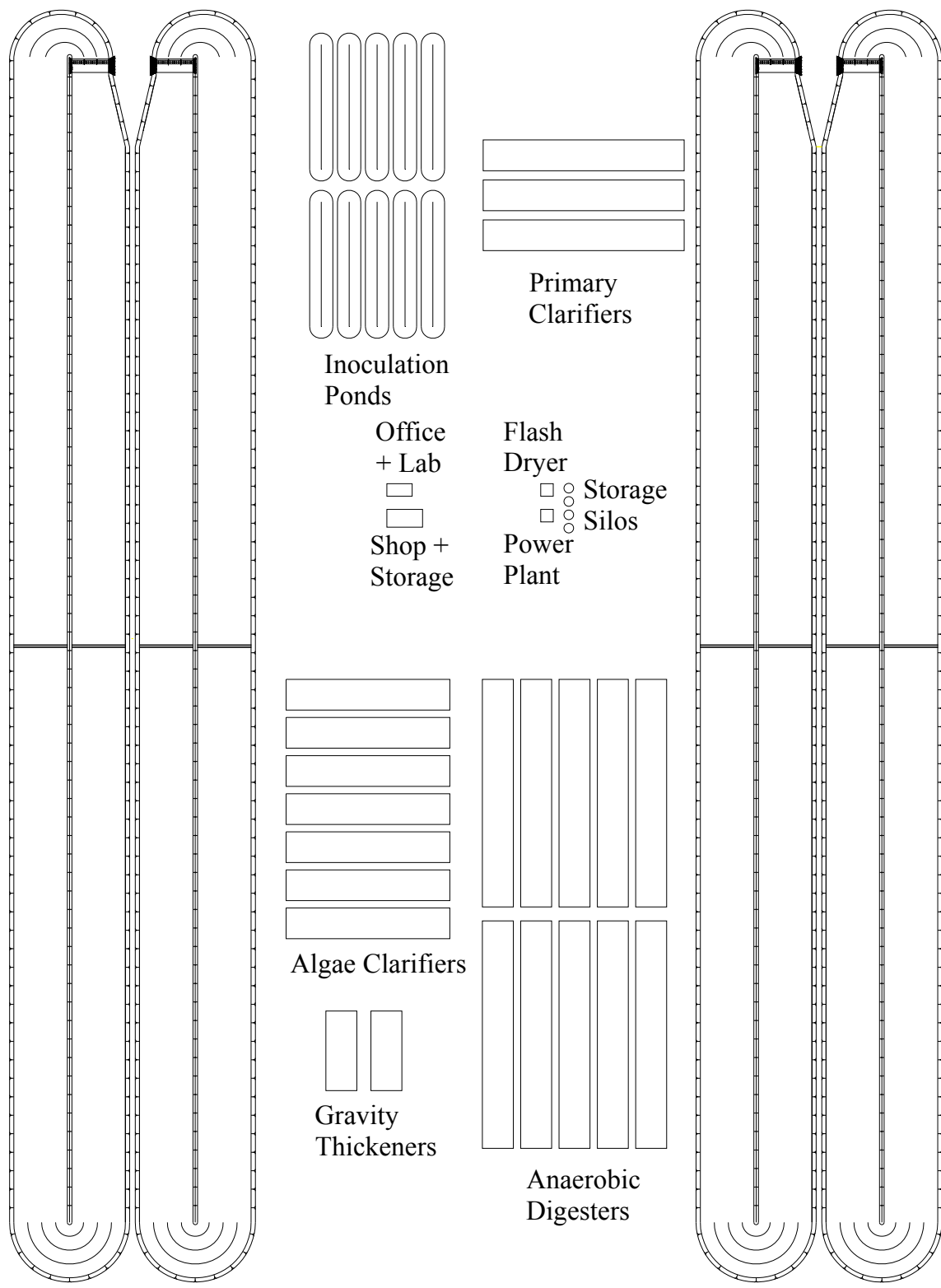

Figure 5.12: Close up on center components of 100-ha facility Case 1

5.5.2 LINER REQUIREMENT AND COSTS

Pond costs are particularly sensitive to the lining material used to prevent groundwater contamination by wastewater or other nutrient growth media, as well as loss of water and nutrients. Along with liner material costs, local regulation and the cost of make-up water and nutrients are the main influences on liner material decisions. There are several methods to prevent water seepage, each with different effectiveness and cost. The least expensive approach is to not line at all and depend on the clay content of the local soil.

Even the lowest possible cost plastic lining (at \$3.50 m² installed) would double pond construction cost compared to a pond lined with onsite clay (Table 5.3). However, such low cost plastic liners would likely not be reliable or long-lasting enough, and doubling this cost is a reasonable minimum estimate for future large-scale installed costs of reliable plastic liners. Reliability is essential, as even small tears will cause seepage of the algae culture under the liners. This resulting anaerobic fermentation and gas buildup under the liner can produce large trapped gas bubbles (or “whales”) resulting in damaged lining. Heavy plastic liners are too expensive, except possibly for wastewater treatment processes.

Table 5.3: Cost comparison between plastic-lined and a clay-lined 4-ha high rate ponds

HRP Capital Cost (\$/pond 4 ha)	
HRP plastic-lined (36 mil)	\$277,000
HRP clay-lined	\$136,000

There are other considerations that must be taken into account when choosing of material for the bottom of the HRPs: leaving the ponds to dry out (one mechanism for managing algae species) could result in cracking of clay liners, which thus would need to have some minimum thickness. These are site-specific details that need to be evaluated on a case specific basis. Weissman and Goebel (1987) used a crushed rock layer to line their ponds, but we consider this also too expensive and not particularly effective. (The main purpose was to prevent silt suspension). It should be noted that the use ponds without plastic liners does not allow cleaning the ponds, and this is one of the major uncertainties in the present design, in terms of ability to maintain a selected algae species in the ponds. Weissman and Tillett (1990) compared both a lined and unlined pond (1,000 m² each) side-by-side and observed only minor differences in productivities. However, the data were much too limited to allow any robust conclusions on this point. As already noted above, about 10% of the ponds are lined with plastic as part of the inoculum production system.

Prevention of berm erosion and weed growth requires a slope liner, such as plastic geomembrane stretching from berm top to pond floor. This is included in the cost estimates below. In addition, the paddle wheel stations and carbonation sump areas are lined with concrete to prevent floor erosion.

5.5.3 CO₂ DELIVERY AND pH LIMITATIONS

The maximum algae biomass productivity is assumed at 4 g/m²-hr and this is the key design constraint in the supply of CO₂. With 47.5% of algae biomass being carbon (for a moderate total oil content of about 25%), and all of this assumed to be supplied by CO₂ gas a supply of 1.9 g C/m²-hr would be required. Based on prior estimates (e.g. Benemann et al., 1982; Weissman and Goebel, 1987), we assume an overall use efficiency of 75% for flue gas (it would be higher for pure CO₂, closer to 85 – 90%), and thus the amount of CO₂ required is 9.3 g/hr-m² or 375 kg CO₂/hr for a 4-ha pond. At a delivery pressure of 1.22 bar and a temperature of 43°C, the density of CO₂ is 2.04 kg/m³. Therefore the volume of CO₂ required is 183 m³/hr-pond. Assuming a volumetric content of 12.5% CO₂, with the balance, mostly N₂ and a little O₂, in the flue gas, the amount of flue gas to be delivered to each 4 ha pond is 1440 m³/hr or 24 m³/min, or 36 L flue gas/m² pond/hr needed. Our design uses one sump spanning both channels and dissecting the ponds, or 60 m in width, thus the flue gas requirement is 24 m³/hr-m_{sump}. Note that with the CO₂ present in biogas, the flue gas coming from combustion of biogas would have a higher CO₂ content than 12.5%. Thus, the flue piping is sized conservatively.

The sump is designed to operate in a countercurrent mode. The dimensions are 1-m deep by 0.30-m wide for each side of the dividing baffle (Figure 5.9). By having the width the same as the depth of pond the downward velocity is the same 0.25 m/s. Assuming an average rise velocity of bubbles to be 0.30 m/s the net velocity of the bubbles through the countercurrent sump are 0.05 m/s. With an overall depth of 1 m, the contact time for the flue gas is thus 20 seconds. The actual contact time will depend on several factors, including bubble size at the orifice, coalescence and channeling. To determine the gas hold-up (gas to liquid volume ratio in the sump), the volume of gas in the sump is divided by the total volume of water and gas. At a downward velocity of 0.25 m/s times for the water and a sump area for 1-m width of sump of 0.3 m², the total flow of water in the sump is 270 m³/hr-m_{sump}. This compares to a flue gas volume of 24 m³/hr-m_{sump}, and thus the gas hold-up is about 9%, for which gas channeling (e.g. slug flow) is not a problem.

The 4-ha pond has a total travel length of 1260 m and with two sumps in the middle of the pond, one for each channel, and with a channel velocity of 0.25 m/s, on average each volume of water will pass through the sump each 0.7 hours. Thus the required re-carbonation of the growth medium must be based on this time constant. From the above (assuming that half the

loss of CO₂ takes place during sparging of the flue gas), 8.1 g CO₂ are required to be transferred into the algae medium at the sumps per hour per m² of pond, to account for losses from outgassing from the ponds. As each volume of water passes through the sump every 0.78 hours, and for a 30 cm deep pond, 21 g CO₂ /m³ would need to be added to the medium during each pass through the carbonation sump at the time of maximum productivity. A total of 22 g CO₂ or 0.5 mole of CO₂ can be added per m³ for an alkalinity of 2.5 meq/l, assuming an allowable pH change (before and after the recarbonation sump) of between 8.5 to 7.5, and an alkalinity of 250 mg/L as CaCO₃ (Weissman et al., 1987). Thus this design meets the maximum CO₂ supply requirements.

Due to organic carbon present in wastewater and recycling of residual wastes, which are different depending on which case study is analyzed, the amount of CO₂ gas that needs to be delivered to the ponds to maximize growth is reduced in Cases 1 through 4. For example, the amount of carbon that is added to a pond from wastewater BOD would be 13 g CO₂/m² (for 3-day retention time or 90 L wastewater added/m²-d, 120 mg/L of BOD and 1.2 g CO₂/g BOD). This would provide only enough CO₂ for two hours at maximal productivity. Additional sources of CO₂ are therefore required, as discussed above. For example, carbon demand can be met through the addition of digester effluent which contains primary sludge and residual algae biomass, as well as from the combustion of biogas. This is also further discussed below.

5.6 OVERVIEW OF INDIVIDUAL CASE STUDIES

Five separate case studies are presented here. The cases were designed to depict two basic scenarios: a large continuous source of wastewater or a limited wastewater source requiring that the water and nutrients are recirculated to the extent possible or necessary. The cases were also designed with varying end product fuel options of either biogas for electricity or algae oil for liquid fuel (with biogas as a byproduct). The individual cases with their main parameters were shown above in Table 5.1. The four initial cases are presented first, each with a pond area of 100 ha and varying between either a wastewater treatment-emphasis and a biofuel-emphasis and either oil or biogas outputs. The final fifth case presented is a 400-ha biofuel-emphasis facility with a limited wastewater flow input and the main product being algae oil.

The cost analyses for the basic algae production facility (pond, harvesting) is based on relatively minor modifications of existing designs for high rate wastewater treatment pond facilities, mainly in the 4-ha single channel pond designs and the productivity and harvesting process assumptions discussed above in Section 5.2.

Large multi-channel unlined, wastewater treatment ponds have been used previously, mixed variously with either pumps, Archimedes screws, or paddle wheels. A set of four 1.25-hectare, paddle wheel-mixed, earth ponds was recently completed at the wastewater treatment plant in

Christchurch, New Zealand, for wastewater treatment and algae biomass for biofuels production. This latter facility provides the closest equivalent to the present design, with a similar channel length but narrower in width.

As the two major costs of pond construction are the paddle wheels and carbonation sumps, there would be little difference in cost estimates for 4-ha vs. 2-ha single channel pond designs, for example, as in both the length of the channel, and thus the combined width of the paddle wheels and sumps would also be similar, The main difference would be the replication of the piping, valves, etc., and the additional berms. This could be left as an issue for future design analysis and option.

5.6.1 CASES 1 AND 2: WASTEWATER TREATMENT-EMPHASIS FACILITIES; 100-HA FACILITY BASE CASE

In these cases, a theoretical, medium-sized, city with a wastewater flow of nominally 62 MLD is assumed (see below for calculations). The following are outside the battery limits of this study: The sewers and influent lift and effluent pumping stations to and from the site and the disposal of the treated effluent (e.g., legal irrigation of certain crops, such as fodder, without disinfection or chlorination-dechlorination followed by discharge to a surface water body).

The difference between the two basic processes that grow algae biomass primarily for liquid fuels (Figure 5.13) or for biogas production (Figure 5.14), is how much of the algae biomass goes to the anaerobic digesters for onsite electricity (and waste heat) production, vs. how much is converted into liquid fuel for offsite use.

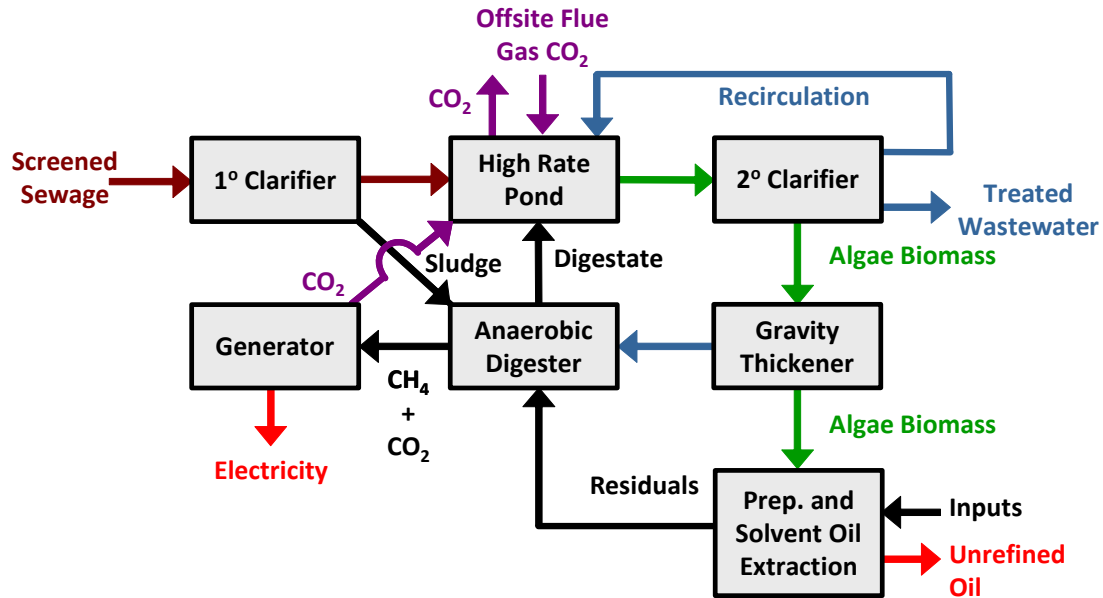

Figure 5.13: Case 1 Process Schematic (wastewater treatment-emphasis and oil production).

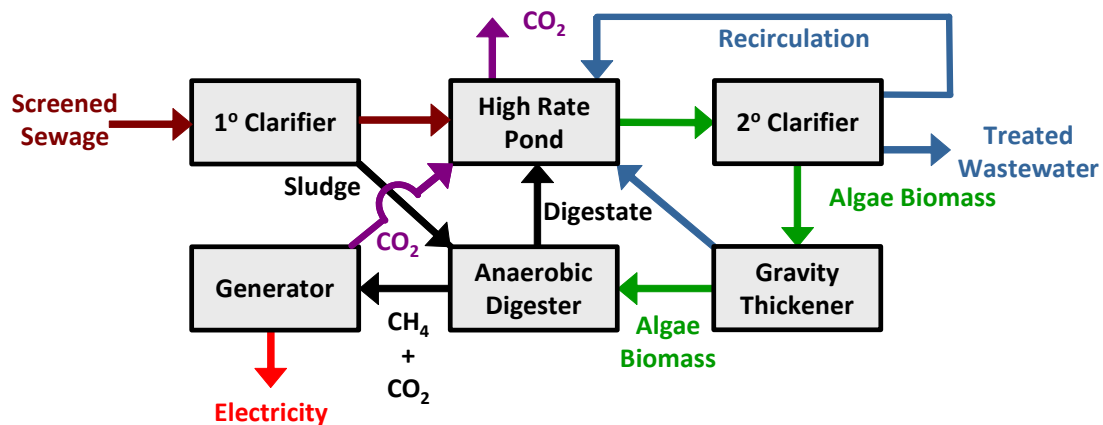

Figure 5.14: Case 2 Process Schematic (wastewater treatment-and biogas production).

5.6.1.1 PRETREATMENT AND PRIMARY TREATMENT

Initial treatment of wastewater influent is through a conventional primary municipal wastewater clarifier. A primary clarifier acts as a sedimentation basin with a continuous solids collection. The purposes of this step are to (1) reduce solids concentration in the wastewater to prevent sedimentation in the shallow HRPs, (2) to help clarify the water to improve photosynthetic efficiency, (3) to reduce BOD loadings, and (4) to provide additional solids for

anaerobic digestion. However, primary clarifiers are only used in the wastewater treatment-emphasis cases to improve treatment, but with added capital cost. For the biofuel-emphasis facilities, primary clarification is omitted as a simplification and with the assumption that primary solids will settle in the HRP, there to degrade and release carbon and nutrients to support algae growth. This however, reduces the amount of biogas produced in the process, thus primary sedimentation could be considered in a future reiteration of the process.

With an influent BOD concentration assumed to be 200 mg/L and a removal rate of 40% by primary sedimentation, the effluent wastewater that is discharged to the HRP is 120 mg/L. The assumed nitrogen concentration in sedimentation basin effluent is 35 mg/L (Metcalf and Eddy, 2003). The main design criteria for a clarifier is the retention time which is usually between 1.5 – 2.5 hrs and the overflow rate which ranges from 30 – 50 m³/m²·d (Metcalf and Eddy, 2003). Using 40 m³/m²·d and a depth of 4.3 m results in reasonable retention times. With a wastewater flow of 62 MLD, a total of 5,190 m³ of clarifiers, with a surface of 1,560 m², are needed. The design selection was to have two operating clarifiers in series with one back up, for a total volume 7,860 m³. The clarifiers are below ground with lined sides and a concrete floor with a continuous scrape and collection system. For the cases with primary treatment, about 166 m³/d of sludge solids are collected (6% volatile solids concentration). These solids are sent to an anaerobic digester for treatment. The energy inputs include the hydraulic motor for the solids scraper and sump pumps to transfer the solids to the anaerobic digester.

5.6.1.2 HIGH RATE POND AND WASTEWATER TREATMENT

After the wastewater passes through the primary clarifier it is then sent to the HRP. An average hydraulic retention time of 4 days average, ranging from 3 days summer to 5 days winter, was already assumed in the above. Oxygen to satisfy biochemical oxygen demand (BOD) is obtained by three main mechanisms: photosynthesis, oxygen in the biogas turbine exhaust which is diffused into the ponds, and oxygen diffused from the atmosphere. The BOD removal rate is based on the requirement of 1.1 grams O₂ per gram of BOD₅ removed (Oswald et al, 1953) and that 1.55 g O₂ are produced per gram of algae biomass. Thus, one gram of algae production would remove 1.4 g of BOD₅. A 62-MLD primary effluent with 120 mg/L BOD₅ will contain 7,480 kg of BOD₅, requiring almost 5,340 kg of algae production. At the highest productivity of 38 g/m²-day, this would require an area of just under 13.5 hectares. With an individual pond area equal to 4 ha and a pond volume of 12,000 m³ for the shortest summer retention time, of three days would require a total of 14 ponds to handle the flow of 62 MLD, or a total area of 60 ha (all figures are rounded here).

Alternatively, a 100-ha facility would need to produce only 5.1 g algae/m²-day, to remove all the BOD₅. This is near the productivity assumed for the two coldest months of the year, and if

allowance is made for additional O₂ diffusion (of at least 1 – 2 g/m²-day), this scale of facility would be able to treat the BOD₅ year-round. Also, in winter, the hydraulic retention times would be longer, at 5 days, and require 100 ha for the 62 MLD of wastewater to be treated.

Thus, for the present design, a 62-MLD sewage flow for the 100-ha facility is specified for the treatment-emphasis cases (Cases 1 and 2). For the biofuel-emphasis cases, the flow would be much lower, depending on the process objectives, such as a high removal of nutrients, or simply using the wastewater as the make-up water and nutrient source, as discussed later.

In summer when the hydraulic retention time is 3 days, resulting in a 103 MLD harvest flow, a total of 41 MLD per day (40% of the 103 MLD pond effluent) would need to be recycled to the growth ponds. In spring and fall with a 4-day retention time, the recycle flow decreases to 21 MLD of pond effluent recycle. In winter, there is no recycle. This internal recycle does not affect the effluent flow from the treatment facility.

To calculate nitrogen uptake in the HRP, the amount of nitrogen likely to be volatilized must also be considered, which depends on the pH of the medium, the outgassing coefficient, the ammonia levels, and other factors. For example, the wastewater would be fed at or shortly after the carbonation stations, where the pH would reduce any volatilization. By the time the algae have used the CO₂ and raised the pH, the ammonia would have already been consumed by the algae. We assume here that there is a loss of 5% of the total nitrogen added to the ponds, both due to outgassing and factors such as consumption by bacteria removed during harvesting, refractory nitrogen, etc. This loss applies to both the wastewater nitrogen and that recycled back from the digesters. Therefore, a concentration of 33 mg N/L is available, which is enough for peak production in summer months.

The algae biomass is assumed to contain 5% nitrogen (assuming that the algae are grown for high lipids). Thus, for a 62 MLD inflow, this would produce a maximum of 38,000 kg/day of algae biomass, which is comparable to the maximum algae biomass output for a 100-ha facility based on maximum summer time productivity of 38 g/m²-day or 39,000 kg/100 ha-day. Thus the pond facility, at maximum summer time productivity would remove 95% of the nitrogen influent. However, this does not include the harvesting efficiencies and digester recycling streams that are considered here in this model, which reduces the maximum summertime N removal rate to 65%. On an annual average, for 22 g/m²-day, the removal rate would be closer to 44%, although it may be possible to increase both the nitrogen losses and the nitrogen content of the algae during the rest of the year (in particular for the case where a high oil content is not required). Under these conditions, the total annual N removal might increase to 75 – 80%. Still, to benefit from nutrient removal credits, such a facility would require an annual or seasonal discharge standard, rather than a monthly one. This type of discharge permitting

seems quite feasible in many locations, where summer nitrogen discharges are a greater concern than winter discharges.

To provide CO₂ to the ponds, two sumps with a depth of 1 m are located transecting the pond. In the bottom of the sumps, ceramic or membrane spargers provide fine bubbles for efficient transfer.

To handle continuous distribution of water flow into the ponds water is pumped from the primary clarifiers into the HRPs, and the flow out of the ponds is by gravity. The ponds are to be graded to all have equal floor elevations, and therefore the total vertical drop required for the effluent of the ponds to drain by gravity is 1.5 m, which is not a significant issue in the overall design. The pump sizing requirement for water transfer from the primary clarifier was calculated to be 59 kW with a pump efficiency of 88% and a motor efficiency of 83%.

5.6.1.3 WATER MAKEUP AND WASTEWATER CHARACTERISTICS

The influent into the HRPs following primary treatment includes concentrations of 35 mg/L nitrogen and 120 mg/L BOD₅ with a pH of 8.5 (Table 5.4). The removal efficiencies for the primary treatment reported in Table 5.4 are typical values that are taken from known wastewater treatment operations. The removal efficiencies for the HRP were calculated based on the algae biomass productivity and known oxygen production rates. Therefore, with an average BOD load to one pond of 12,500 kg/d and an average daily biomass production of 8,220 kg/d-pond, the algae produces well over 100% of the required O₂ for oxidation.

Table 5.4: Wastewater characteristics and removal efficiencies

	Wastewater characteristics		
	Influent (mg/L)	% removal	Effluent (mg/L)
<u>Primary treatment</u>			
Total Nitrogen	35	0%	35
BOD ₅	200	40%	120
pH	8.5		
<u>High Rate Ponds</u>			
Total Nitrogen	35	3%	34
BOD ₅ ^A	120	88%	14
pH	8.5		

A. 100% BOD₅ removal for 8 months per year.

5.6.1.4 CO₂ DISTRIBUTION

To balance the algae growth on N with the C available in the primary effluent fed to the ponds, additional CO₂ must be supplied. Carbon is supplied through BOD₅ in the primary treated wastewater. Even with some additional inorganic carbon available in the wastewater, between 80 to 85% of the carbon required for algae growth in peak summer and well over half on average over the year will have to be supplied as CO₂ through the sumps. The source of this CO₂ is thus a major issue. It can come from two sources: the recycle of flue gas from the biogas generated from both the algae biomass and primary sludge or an exogenous source. The flue gas requirements to maintain maximum algae productivity for Case 1 are described below.

A maximum flue gas requirement for an individual pond, calculated previously, is 24 m³/hr-pond to maintain peak hourly biomass productivity, absent any wastewater carbon. The annual average flue gas requirement, however, is lower at 13.7 m³/min-pond (during daytime). This is assuming an uptake efficiency of only 75% and a CO₂ concentration of 12.5% (by vol.). With distribution to a total of 25 ponds, the blower must be designed to handle a maximum of 611 m³/min and overcome any head loss.

Friction loss in the pipes was found using the Haaland equation, with total head loss found using the Darcy-Weisbach equation. The gas is distributed into the pond by ceramic disc spargers, which have a head loss of 1 psi across the membrane. The depth of the spargers is 1 m in a concrete sump, which is equivalent to about 0.1 atm (1.4 psi, assuming no gas void volume). The piping system requires pipe diameters up to 90 cm for flue gas to reduce total head loss. The total head loss for the system is 2.5 psi. The assumed flue gas temperature is 43°C. The maximum power required to deliver the required flue gas and overcome the head loss was calculated using the equation of power requirement for adiabatic compression and is 342 kW or 459 hp for the 100 ha facility. Based on 10 hrs/day of sparging, the average energy required for the CO₂ distribution is found to be 1,910 kWh/d, or less than 1 kW/ha. Annual average power requirements are even lower.

5.6.1.5 PRIMARY DIGESTION

The solids collected in the primary clarifiers are anaerobically digested, as commonly practiced in conventional wastewater treatment facilities. The solids concentration from primary clarification can range from 4 – 12% (Metcalf and Eddy, 2003); 6% solids was used in this analysis. Of these solids, typically about two third or 4% are volatile that will break down in the anaerobic digester (Metcalf and Eddy, 2003). For these volatile organics their chemical oxygen demand COD is 1.42 g O₂/g VS. A yield of 0.39 L CH₄/g COD destroyed is commonly used to determine the methane yield. With the starting wastewater influent of 62 MLD to the primary clarifiers about 6,978 kg VS/day (166 m³) of sludge can be collected and sent to the anaerobic

digester. The conversion of VS to methane can thus produce about produce a total of 3,860 m³/d or 151,000 MJ/day (for an energy density of 39 MJ/m³). With an assumed power generation efficiency of 30% (e.g. a heat rate of 3.6 MJ/kWhr), this amount to just under 13 MWh/d that can be produced from the primary sludge (all numbers rounded).

Two options for the anaerobic digesters designs were considered: traditional municipal mixed tank concrete reactor and agricultural animal waste plug flow earthen reactor with plastic liner and cover. The main design parameter is maintaining a long enough hydraulic retention time, which is affected by temperature during winter time. A typical hydraulic retention time of 20 days was chosen for the complete mix digester and a 30-day retention time for the plug flow digester. However, as discussed below, we consider co-digestion of the primary sludge with algae biomass.

5.6.1.6 ALGAE HARVESTING

We assume algae harvesting to use a natural process of flocculation followed by gravity settling (“bioflocculation”), without any addition of chemical flocculants. This process is analogous to the flocculation observed in the activated sludge waste treatment process. Bioflocculation avoids the need for polymer or alum flocculation. Bioflocculation of algae has been demonstrated in pilot scale in the US (Benemann et al., 1980) and New Zealand (Craggs and Park, 2009). It has been the subject of extensive laboratory studies, but remains to be demonstrated at a full-scale process. Along with the productivity and algae oil content, bioflocculation is a central assumption of this analysis. Contrary to earlier studies (Benemann et al., 1982; Weissman and Goebel, 1987), which assumed a batch settling process requiring relatively large settling basins, we assume in the present design a continuous below-ground clarifier with a six-hour retention time that can remove 95% of the algae biomass. This biomass is collected in a sump in the bottom of the clarifier with an initial 1.5% solids concentration, approximately a 40- to 60-fold concentration factor. An alternative, or even additional, sedimentation technology option is lamellar plate or tube settling, as used in the Christchurch, New Zealand facility (Craggs and Park, 2009). However, their costs would be higher than the clarifier option chosen herein.

During summer and highest period of harvest, with 10 cm/day hydraulic loading and a cell concentration of 380 mg/L in the pond water, a total volume of 23,200 m³ of clarifiers would be required for a 100 ha facility, assuming 24-hour/day harvesting. In other seasons, harvesting would be reduced to as little as 58,500 m³/d, allowing reduced operations. Seven clarifiers, each of 3,900 m³, working volume, for a 100-ha facility would allow one to be out of service at any time for maintenance.

The settled solids, at a max of 2,370 m³/day, are then sent to a gravity thickener, which again has an assumed capture efficiency of 95% with a nominally 3% solids concentration as output, giving a maximum summer-time final volume of 1,120 m³/day for a 100 ha facility. During other times of the year, this volume would be reduced to as little as one-tenth this amount. With a HRT designed to be 4 hrs, the total volume (with one unit as back-up) required for gravity thickening is 400 m³. Two units are specified, one as backup. Note that these are the maximum, peak productivity requirements. For the average annual productivity of 22 g/m², the flow would be reduced to about 670 m³/day (after allowance for losses during the harvesting).

The supernatant of the first algae clarifier is either seasonally recycled depending on the desired HRT (Cases 1 and 2) or is fully recycled to the HRP for further propagation of algae (Cases 3 to 5). The supernatant from the gravity thickener is sent back to the influent of the ponds for all cases. One aspect not considered is the effect of the residual algae biomass on the process: the non-settling algae may affect the algae species composition. To avoid promoting non-settling algae, the recycle flow may require sand filtration, at least occasionally.

5.6.1.7 ALGAE BIOMASS PROCESSING INTO FUELS

The algae biomass collected by the gravity thickener would be either used for oil extraction followed by anaerobic digestion of the residues, or sent directly to the anaerobic digesters (possibly adding a heating/pasteurization step to make the algae more susceptible to bacterial breakdown).

5.6.1.7.1 ANAEROBIC DIGESTION

For anaerobic digestion, some type of pretreatment, such as pasteurization (e.g., heating to 70°C) or cell disruption (e.g., a pressure cell, sonication), may be beneficial to improve digestion by making the cellular contents more available to lytic bacteria. The details will depend on the specific type of algae biomass produced, and even the algae cultivation conditions. Further heating and/or cell disruption-plus-digestion will require energy input, and this would affect the overall energy balance of the process. In this analysis, such pre-treatments to increase methane yield are omitted, but the design and costs for warming the digesters using waste heat from onsite electrical generation is included, as this is standard practice.

For anaerobic digestion of the biomass, concentration by gravity thickening to 3% solids is adequate to allow reasonably-sized digester vessels (~30-d residence time) at approximate loading rates of 0.8 and 1.1 g VS/L-d for Cases 1 and 2, respectively. In the simplest cases considered here, the concentrated algae from the gravity thickeners is pumped directly to the anaerobic digesters. Heating of the digester influent is possible through use of waste heat from the onsite generator. Insulated pipes transfer heat from the generator to the influent of each

individual digester. In winter periods, loadings are much lower, allowing a 60-day or longer retention time. The algae biomass is assumed to contain 5% N in all cases. As a simplification, the biomass residual after oil extraction is assumed to have the same composition and biogas yield in anaerobic digestion as the biomass that does not undergo oil extraction. However, by necessity, the extraction residual would have a higher N content. Further, we assume that the algae biomass in all cases contains 47.5% C, and that the algae oil contains 72% C (as in C16 & C18 triglycerides). Thus, after oil extraction, the residual biomass contains 39% C.

Agricultural-style earthen plug-flow digesters are used. The walls of the digesters are plastic lined, and the floors are concrete to facilitate solids removal. Cases 1 and 2 receive different inputs into the anaerobic digester and are sized accordingly. For Case 1, a maximum, 26 m³/d of spent algae biomass after oil extraction are sent to the anaerobic digesters as well as 1,240 m³/d of gravity thickener supernatant and 166 m³/d of primary sludge. With a maximum total flow of 1,430 m³/d for the flows described above and a 30-day retention time, a total volume of 42,900 m³ of digesters is required, which is divided into ten digesters of 4,290 m³ each. These are 4.3 meters deep, 17 meters wide on average and about 122 m long, requiring less than one quarter of a hectare of footprint, which is closer to a covered anaerobic lagoon than a conventional plug flow digester. For Case 2, the maximum inflows to the anaerobic digester include 1,120 m³/d for the gravity thickener supernatant and 166 m³/d for the primary sludge. This flow requires 10 individual digesters of 3,870 m³ each, which is only slightly smaller than those required for Case 1. The resulting loading rates for Cases 1 and 2 are 0.8 and 1.1 g/L-d, respectively.

The assumed yield of methane from anaerobic digestion is 0.3 L CH₄/ g VS, and for simplicity, the same yield is assumed for primary sludge. The methane production prediction is based on this yield, the annual average harvested biomass of 20 g/m²-day or 20 mt/day for 100 ha, and the flows of primary sludge and gravity thickener supernatant described. The total dry weight mass of these flows totals to a loading of 27 mt/day for Case 2 (no oil extraction). This biomass yields 8,190 m³/day of methane, equivalent to 319,410 MJ/d (at an assumed HHV of 39.0 MJ/m³). This gas production almost doubles during the peak of summer. With a gas turbine with 30% efficiency, this would generate about 27 MWh/day of power on an annual average, and up to 40 MWh/day during summer. The 30% efficiency for the gas turbine can be expected and is in the higher efficiency ranges for gas turbines between one and five MWe (Poullikkas, 2005). The assumed composition of the biogas is 35% CO₂ and 65% CH₄ with trace amounts of H₂S, which is scrubbed out. The flue gas leaving the turbine is assumed to contain 12.5 % CO₂. A selective catalytic reduction system to treat exhaust is specified to meet potential local NO_x emission requirements. For Case 1, after oil extraction, the methane yield would be 23 MWh/day, which is only slightly lower than Case 2 that has oil extraction where the oil would contain a large fraction of the methane potential. Note that the same 0.3 L CH₄/ g VS methane

yield is used for algae after oil extraction. Only the mass of the algae has been reduced. The disruption of the algae cells during extraction is assumed to increase digestibility and methane yield.

5.6.1.8 ALGAE OIL EXTRACTION

A key issue is whether to extract the algae oil from wet or dry biomass. Drying (spray, drum, etc.) using biogas or any other fuel is not feasible due to the high energy requirements. With a heat of evaporation of water of 4.5 MJ/kg, the amount of heat required to dry 671 m³/d of 3% solids to 80% is 2,910,000 MJ/d. This compares to only 319,410 MJ/d of methane produced from the anaerobic digestion (see above). Solar drying is therefore the only feasible method to dry the biomass without additional fuel consumption. However, oil degradation may occur during drying. For this, a shallow (1 cm) layer of algae slurry is spread over a low-density polyethylene liner to allow for drying to at least 80% solids within one day. Concrete tracks are laid down to allow a modified scrapper or vacuum truck to harvest the dried algae without damaging the liner. For the peak summer harvest of 1,120 m³ per day of algae, at 100 m²/m³, a total of 11.2 hectares of drying beds is required. Such a large area requiring biomass spreading and recovery will require advanced mechanization such as the vacuum truck equipment mentioned above.

A detailed oil extraction process including electrical and heating requirements, as well as a cost estimate, was prepared by Crown® Iron Works Company, a major supplier of equipment for vegetable oil extraction. Their designs were specifically meant for dried algae biomass, and extraction plants of several scales were considered in the present engineering model. (The extraction process is described in detail in Appendix 2.) Since algae oil has not been extracted at full scale, pilot testing will be required to validate these estimates. The basic system consists of the solar dried algae biomass flakes (see above) at 80 – 85% moisture to be sent to a natural gas-fueled flash dryer to bring the dry weight up to 90 – 95%. The algae biomass is then stored in silos at the pond sites to allow a steady flow of biomass to be hauled to a centralized oil extraction facility. After the algae biomass is received at the centralized extraction facility, the biomass is prepped with the equivalent of an extrusion process or an expander (a technique common in the oilseed industry but which must be tested for efficacy with the dried algae flakes). After the biomass has been prepped, it is sent to a continuous-counter-current immersion type extractor that uses hexane solvent. The extractor unit contains several heat recuperators, where heat is recover for other streams. The hexane is eventually evaporated and then condensed to be recovered and recycled back through the process. A specific local site factor considered was the location of the Salton Sea site at –56 m sea level, which requires more energy to bring liquids to a boil. In all cases, the spent algae biomass is hauled back to the algae facilities to allow for nutrient and carbon recovery. Although there is an increased cost

due to hauling of the biomass to a centralized facility, a centralized oil extraction facility was still chosen over onsite extraction due to cost scaling issues described below (Section 5.7.4).

Crown provided estimates for preparation/extraction facilities of 105- and 4,000-metric ton/day (dry weight) biomass. The electrical and heating requirements are 851,000 kWh/d and 33,100,000 MJ/d for the 105 mt/d facility and 16,000,000 kWh/d and 962,000,000 MJ/d for the 4,000 mt/day facilities, respectively (Table 5.5). A single algae facility is not designed to meet the biomass demand for one oil extraction facility, instead the oil extraction facilities are shared co-operatively. Five algae facilities share the capital and operational costs of one 105 mt/d-oil extraction facility, and fifty 400-ha facilities share one 4,000 mt/d facility. These shared energy requirements and associated costs were used in the design of Case 1, 3, and 5.

The main scale-related costs of the process are capital investment and labor, and these present a large economy of scale, as discussed further below.

5.6.2 NUTRIENT AND CARBON BALANCE, PARASITIC ENERGY, OUTPUTS

5.6.2.1 PARASITIC ENERGY

Collectively, the energy consumed to operate a 100-ha facility is an average of 10 MWh/day, or about 4.1 kW/ha and is shown by operation in Figure 5.15. Using Case 1 for illustration, the major part of the energy, 49%, is consumed by the mixing of the HRPs (Figure 5.16). The energy required for pumping for the influent water, primary sludge, and settled are the next major energy consumers followed by the oil (solvent) extraction and CO₂ distribution (Figure 5.16). The oil extraction energy demand is the shared fraction of the centralized plant that is shared by the individual algae facilities (Table 5.5). The extraction process is described in detail in Appendix 2.

Table 5.5: Heating, electrical, and staffing requirement of solvent extraction facilities handling either 105 or 4,000 mt/d amounts of biomass.

	Extraction Plant with 105 mt/d of Feed	Extraction Plant with 4,000 mt/d of Feed
Barrels Produced per Day at 25% Oil Content (bbl/d)	174	6,750
Area of Algae Ponds Needed to Supply Extraction Facility (ha)	500	20,000
Electrical Requirement (kWh/d)	2,330	43,800
Heating Requirement (MJ/d)	90,700	2,640,000
Number of Full Time Operators	27	27
Number of Full Time Managers	3	3

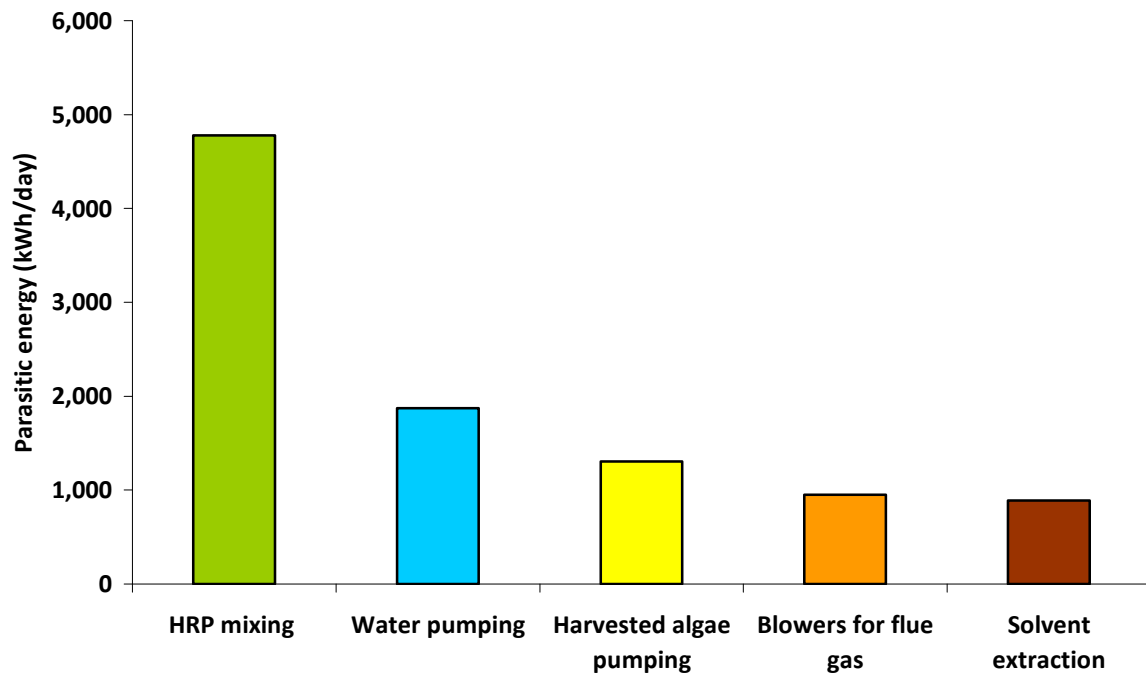

Figure 5.15: Parasitic energy requirements for Case 1 (100-ha)

Note: The solvent extraction energy shown is the proportion of the shared centralized extraction plant energy associated with processing the algae from a 100-ha production facility.

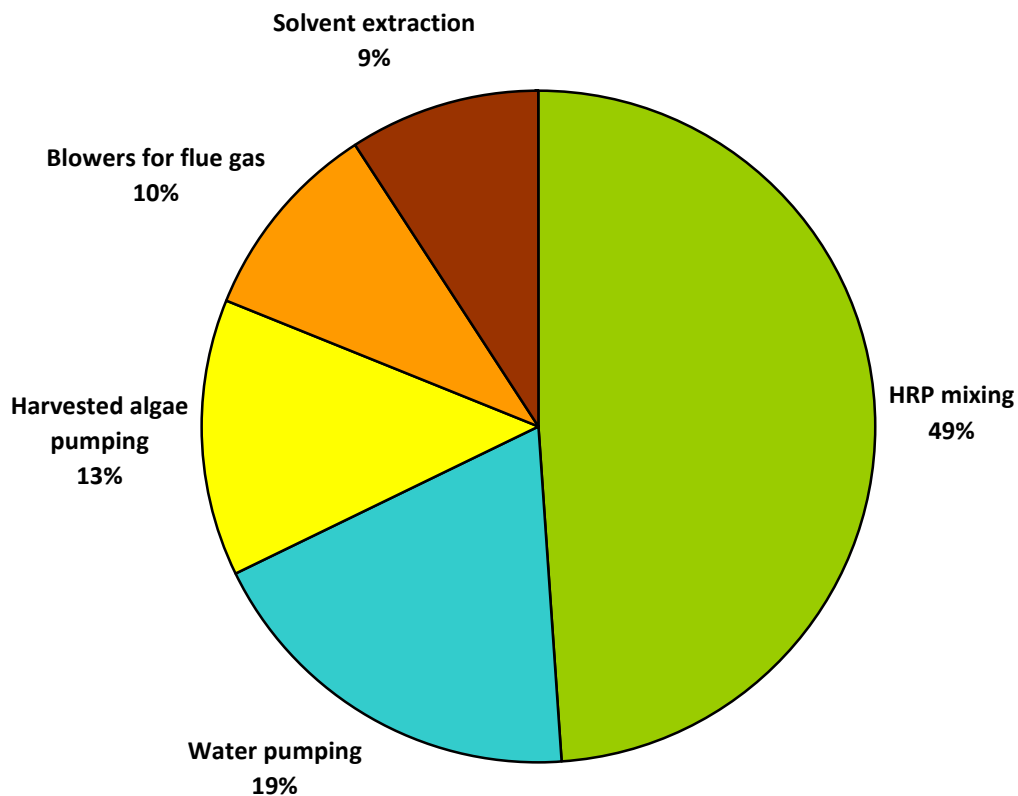

Figure 5.16: Parasitic energy requirements breakdown by operation for Case 1 (100-ha)

Note: The solvent extraction energy shown is the proportion of the shared centralized extraction plant energy associated with processing the algae from a 100-ha production facility. Recirculation lift of influent and effluent not included.

5.6.2.3 RECYCLING OF NUTRIENTS AND CARBON

Water and nutrients, including carbon, are assumed to be recycled onsite to the degree possible, and required to reduce costs. The three factors, water, carbon, and nutrients (principally N, which is used also as a proxy for other nutrients, in particular P) must be considered for each case on a seasonal basis.

For Case 1, which exports 25% of the algae biomass and almost 40% of the algae carbon content as oil, the CO₂ available in the flue gas produced from the combustion of the biogas derived from the algae biomass is also reduced by a similar amount. This results in a deficit in

carbon in the system that must be made up by importing either additional wastes (e.g., animal manure) for co-digestion with the algae biomass or, alternatively, a flue gas from a power plant or similar source, the latter being the option used in this analysis.

For Case 1, which uses wastewater treatment in combination with both biogas and oil production, there is only a need for an external source of CO₂ for a part of the year to supplement what can be delivered from the wastewater, the recycled nutrient flows, and the recycled flue gas from the anaerobic digestion of the primary sludge and the algae biomass (Figure 5.17). While for Case 2, which uses wastewater treatment in combination with biogas production, there is a surplus of CO₂ being produced from the combustion of biogas throughout the entire year (Figure 5.18).

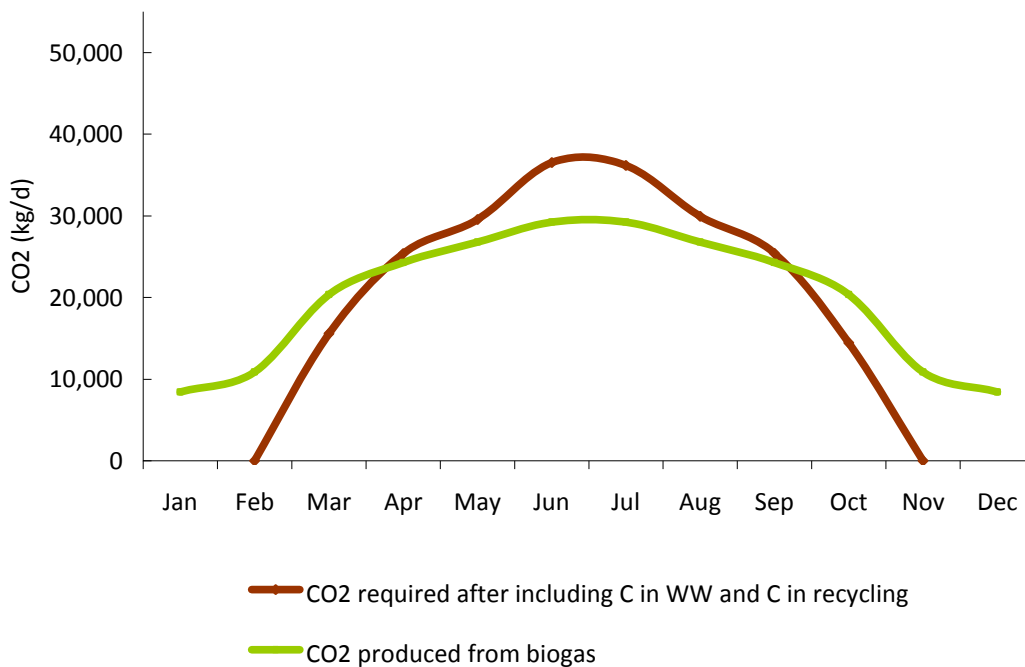

Figure 5.17: Case 1 CO₂ Requirement and CO₂ produced onsite. Requirement is accounted for carbon in wastewater and in the recycling digester effluent and 2^o clarifier supernatant.

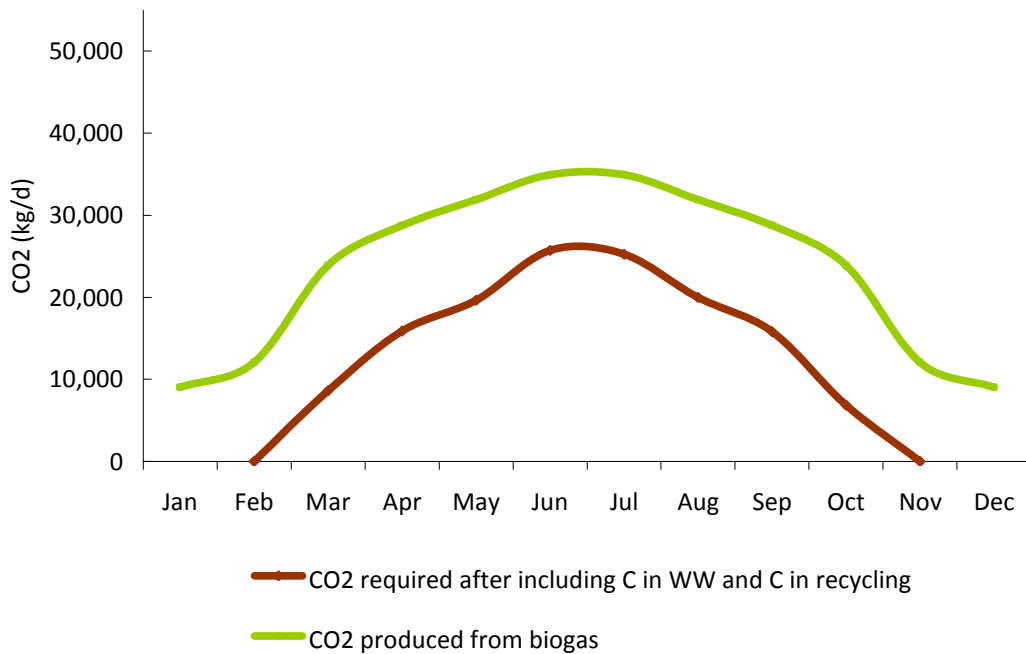

Figure 5.18: Case 2 CO₂ Requirement and CO₂ produced onsite. Requirement is accounted for carbon in wastewater and recycling of carbon in digester effluent, 2° clarifier supernatant, and gravity thickener supernatant.

For all cases digester effluents are also recycled to keep nutrients on site. The assumption was made that digester effluents would not cause significant light limitation due to the build-up of non-biodegradable substances. This is reasonable considering the small amount of digester volume added to the ponds on a daily basis and the highly aerobic nature of the ponds. The timing and place of addition of the digester effluents (as well as, for that matter, of the wastewaters) would be optimized to help manage nutrient, pH, DO, and light levels in the ponds and to minimize outgassing of ammonia and CO₂ from the ponds.

5.6.2.4 OUTPUTS

The total amount of oil produced for Cases 1 and 3 is based on an assumed 25% oil yield from the biomass, with an oil density of 0.92, or 1,087 L/mt. For a harvested productivity of 74 mt/ha-yr (20 g/m²-day), the oil production would be 20,200 L/ha-yr (2,159 gallons/acre-yr or 12,700 barrels/yr) for Case 1 (Table 5.6). In addition, the gross energy that is available from anaerobic digestion for Case 1 is 99,700 x 10³ MJ/yr before including engine efficiency, making the total gross energy production 173,000 x 10³ MJ/yr (23,300 MJ/mt or 7,610 MJ/ML) (Table 5.6). Case 2 has a much lower gross energy production of 117,000 x 10³ MJ/yr (15,700 MJ/mt

or 5,140 MJ/ ML) (Table 5.6). This difference is caused by the higher recovery of oil energy compared to biogas. Table 5.6 show gross outputs, the energy required for their production still needs to be addressed. An additional cause of more energy being extracted in the oil-producing cases than the biogas cases is the higher energy content of lipid-rich algae strains versus common strains.

Table 5.6: Gross energy production for Cases 1 and 2.

Case	Influent (ML/yr)	Harvested Biomass (mt/yr)	Biofuel Type	Product Quantities	10 ³ MJ/yr	MJ/mt algae	MJ/ML WW influent
1	22,740	7,440	Oil	12,700 bbl/yr	73,400	9,870	3,230
			Biogas	2,560,000 m ³ CH ₄ /yr	99,700	13,400	4,380
			Sum		173,000	23,300	7,610
2	22,740	7,440	Biogas	3,000,000 m ³ CH ₄ /yr	117,000	15,700	5,140

Note: The biogas energy above includes that from digestion of both primary sludge and algae biomass, but the MJ/mt refers to the dry mass of algae harvested. The high heating values (HHV) of 39.5 MJ/kg for unrefined oil and 39 MJ/m³ CH₄ are used. Barrels (bbl) are 42 US gallons or 159 L.

The algae biomass harvested for Case 1, which varies from 4 – 34 mt/d and is stored onsite in silos, is sent in a steady flow of 20 mt/d to a centralized oil extraction facility, along with the biomass produced at four other facilities of equal size, as described above. The 100 mt/d oil extraction facility is then capable of producing 174 bbl/d of algae oil (Figure 5.19). The spent algae biomass is then sent back to the algae facility where it is stored in silos and fed back to the ponds according to carbon demand. Cases 1 also has excess electrical energy produced onsite from biogas production of 3 to 21 MWh/d totaling 4,780,000 kWh/yr (Figure 5.19).

Cases 2 produces between 3 and 28 MWh/d to total of 6,300,000 kWh/yr from biogas production (Figure 5.20). Both cases produce treated wastewater achieving total nitrogen removal rates as high as 65% during summer and an annual average of 44%. Ignoring atmospheric re-aeration in winter, complete BOD₅ removal is achieved for 8 months of the year, and an annual average of 88% is achieved (Table 5.4).

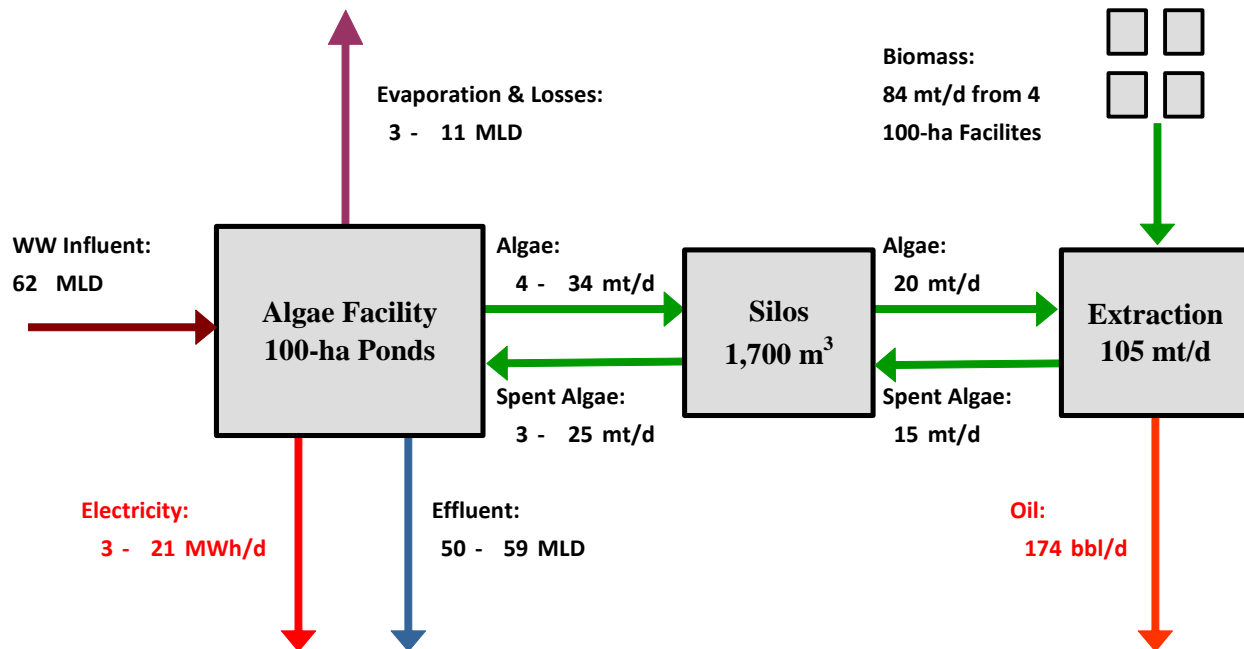

Figure 5.19: Simplified mass balance for Case 1 (Wastewater treatment-emphasis + oil), showing seasonal variations and fuel and electricity production.

Note: This figure does not show the additional natural gas that is imported and combusted on-site (between 0.2 – 1.2 MW) to make up for carbon demand.

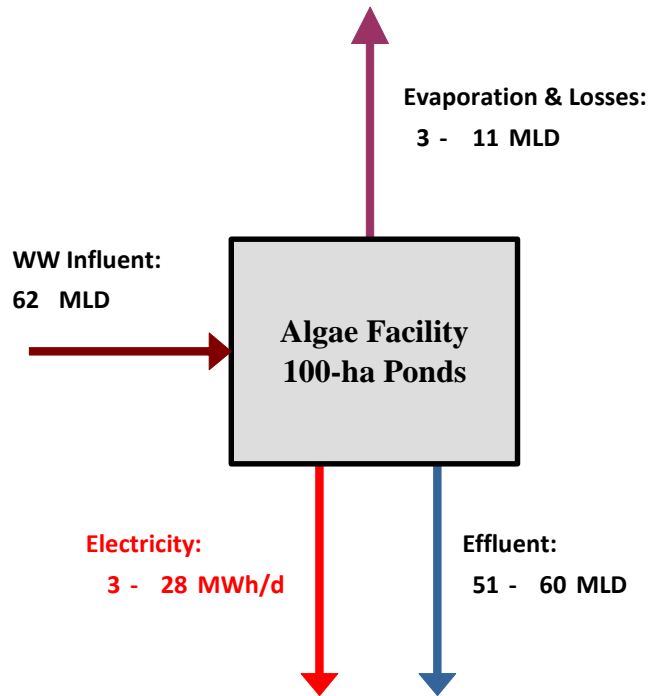

Figure 5.20: Simplified mass balance for Case 2 (Wastewater treatment-emphasis + biogas), showing seasonal and electricity production.

Note: This figure does not show the additional natural gas that is imported and combusted on-site (between 1.0 –2.3 MW) to make up for carbon demand.

5.7 COST ESTIMATING METHOD

The majority of the cost analyses were based on unit construction costs from the RS Means CostWorks® software (2009 edition, Palm Springs location index)³. Costs for specialized unit processes were estimated using construction cost information from several major environmental engineering consulting firms and utilities, who had participated in recent large-scale wastewater engineering projects in southern California.

³ For the purposes of adjusting the costs estimated herein to different locations or after further construction inflation, the Engineering News Record Construction Cost Index basis for this study is 9799 (2009 Los Angeles/San Diego area).

5.7.1 ACCURACY OF THE ESTIMATE

The level of accuracy of engineering cost estimates depends on the effort put forth and the knowledge of the actual project conditions and details. The Association for Advancement of Cost Engineering (AACE) provides a guideline to the level of detail in a cost estimate. AACE defines five estimate classes:

- Class 1 is the Full-Detail Estimate, which is based on detailed unit cost and quantity take-off estimates from final plans. These estimates are generally accurate to within -10% to +15% of actual construction cost.
- Class 2 is the Bid Estimate for which engineering is 30% to 70% complete and accuracy is -15% to +20%. The engineering is completed through preparation of diagrams showing process flow, utility flow, piping, and instrumentation; heat and mass balances; final layout drawings; complete equipment lists; vendor quotes, etc.
- Class 3 is the Budgeting or Authorization Estimate, which includes process and conceptual utility diagrams, site layout drawings, and a nearly complete listing of major equipment and assemblies. Cost accuracy ranges from -20% to +30%.
- Class 4 is the Feasibility or Pre-Design Estimate, which is prepared using cost curves and scaling factors for major processes. Cost accuracy ranges from -30% to +50%.
- Class 5 is the Conceptual Estimate, with an accuracy of -20% to +100% of actual cost.

The current study can be considered Class 3, with some Class 2 aspects, such as mass and heat balances, while other aspects are at Class 4, e.g. oil extraction. Full Class 2 estimates will require decisions on the final suite of processes and technologies to be used and information on likely facility sites. In contrast to the construction costs, the cost per unit of fuel produced will be most sensitive to algae biomass quality (e.g., lipid content) and climate, not process components.

5.7.2 COMPARISON OF MUNICIPAL AND AGRICULTURAL FACILITY COSTS

The engineering design and construction cost estimating of algae biofuel production facilities straddle the major divide between standards and practices of agricultural engineering and those of the chemical and civil engineering. Algae biofuel production, using hundreds of ponds of several hectares each, is essentially a form of agriculture, actually aquaculture, and thus would use the same low-cost approaches and practices used in agricultural and aquacultural engineering, rather than chemical or civil engineering practices. Of course, where municipal wastewaters are used for algae growth, or when solvents are required for algae oil extraction, aspects of civil and chemical engineering practices and costs will need to be applied. For example, for domestic wastewater treatment facilities, legal mandates could require bidding

processes, use of union labor, and higher standards of health and safety than applicable in agricultural systems. In the following facility designs and cost estimates, agricultural engineering components and costs are used for the algae production facilities (the ponds, water and nutrient supplies, harvesting, and algae biomass handling facilities), with chemical and-or municipal practices and cost estimates applied for the algae biomass processing (e.g. oil extraction) facilities. Prevailing wages were assumed for all construction labor except land grading, which was estimated at an agricultural rate. Equipment lifetimes assumed, with no salvage value, were: vehicles 10 years, gas turbines 15 years, other major equipment 20 years.

Table 5.7 illustrates the differences in the unit costs of algae production systems designed with typical municipal wastewater treatment facility equipment and engineering designs and systems designed for agricultural standards. The items with the greatest differences are tank-based technologies such as anaerobic digesters and clarifiers. In the municipal realm, these would be constructed of steel-reinforced concrete with somewhat intricate inlet, outlet, and sludge handling components. The costs of such designs are excessive for a biofuels application, and instead earthwork structures, such as covered lagoon digesters and settling basins commonly used in agriculture, were taken as the basis for design of clarifiers, thickeners, and digesters at the algae biofuel facilities.

Table 5.7: Comparison of unit capital costs for municipal and agricultural engineering design standards for components needed in an algae biofuel plant.

	Traditional municipal wastewater treatment technology	Farm-based wastewater technology
Land (\$/ha)	\$30,000	\$15,000
Primary Clarifier (\$/1000 m ³)	\$2,850,000	\$59,500
High Rate Pond (\$/ha)	\$69,200	\$34,100
CO ₂ Delivery System (\$/ha)	\$5,940	\$5,940
Water Transfer System (\$/ha)	\$10,200	\$10,200
Algae Settling Units (\$/1000 m ³)	\$2,850,000	\$36,700
Algae Gravity Thickeners (\$/1000 m ³)	\$2,850,000	\$648,000
Anaerobic Digesters (\$/1000 m ³)	\$1,400,000	\$56,600
Algae Drying Beds (\$/ha)	\$197,000	\$197,000
Gas Turbine (\$/kW)	\$1,470	\$1,470
Vehicles (\$/100ha)	\$100,000	\$100,000
Electrical (\$/100ha)	\$1,900,000	\$1,900,000
Buildings (\$/100ha)	\$120,000	\$120,000

5.7.3 CONSTRUCTION COST MULTIPLIERS

Following normal cost estimating procedures, base equipment costs were multiplied by factors to account for installation, and overall facility construction costs were increased by factors to cover the costs of engineering, administration, contractor-related costs, and permitting. Selection of the values of these multipliers has a large effect on total estimated costs, but the selection of the multiplier values is a matter of judgment considering project scale, local conditions, market competition for materials and services, and project complexity (including technical, logistical, and administrative complexity).

For the present study, medium to low multipliers were used since pond construction is relatively simple and repetitive, and the envisioned sites are degraded agricultural land, already cleared and with only gentle slopes. Land grading equipment is readily available in the Imperial Valley, but pond lining, power generation, and instrumentation contractors likely would have to travel from urban areas, increasing mobilization-demobilization costs.

Algae biomass handling, processing, and oil extraction required the majority of the large equipment at the facilities. Installation costs for this equipment were estimated using multipliers of the equipment purchase price (Table 5.8). The overall construction cost multipliers (Table 5.9) were selected from southern California wastewater treatment plant construction estimates prepared by various major engineering organizations and from cost estimating references (e.g., Ogershok and Pray, National Construction Estimator 2009; Kawamura and McGivney, 2008). Prevailing wages were assumed for all but land grading costs, which were at an agricultural rate. Details on the costs included in the factors are provided below. Sales tax was omitted from the cost estimates, but with material costs comprising about 20% of total costs and sales tax at 8.75%, sales tax would amount to about a 2% addition to total cost.

Table 5.8: Algae biomass processing equipment installation cost multipliers.

Equipment Type	Multiplier Selected
Algae flake final drying and preparation ¹	2.0
Solvent extraction facilities ^{1,2}	3.0

1. Per Crown Iron

2. Facility will be subject to National Fire Protection Association NFPA 36: Standard for Solvent Extraction Plants.

Table 5.9: Cost multipliers on construction cost subtotals for all cases.¹

Cost Multipliers		
Item	Typical Range for Wastewater Treatment Facilities	Selected for the Present Study
Mobilization-demobilization	1.02 – 1.10	1.10
Yard Piping ²	1.10 – 1.15	1.10
Engineering	1.02 – 1.20	1.05
Legal and Administration	1.02 – 1.05	1.02
Construction Management	1.03 – 1.12	1.12
Contractor Overhead and Profit	1.05 – 1.35	Variable ³
Construction Insurance, Bonds	1.01 – 1.06	1.04
Contingency	1.05 – 1.15	1.10
Permitting	1.005 – 1.02	\$100,000 lump sum

1. Projection of cost escalation during construction is omitted
2. Yard piping estimated as 1.10x the cost to construct the components of the central area of each pond facility. Piping to main high rate ponds was estimated separately. Site work needs assumed to be minimal.
3. Depending on component. RSMMeans 2009 CostWorks[®] was the source for profit and overhead.

The specifics of the cost multiplier categories are as follows: Yard piping covers the connection of the various treatment units within the central area of the algae facilities. This piping includes process piping, building piping, minor drainage, and telecommunications lines. Yard piping costs are included in the estimates of the central plant components, and so no discrete yard piping estimates are shown in the summary facility costs tables. The Engineering category covers the cost of design (preliminary through final detailed design and specifications) and ancillary engineering services such as special investigations, surveys, foundation reports, bidding, location of utilities, start-up assistance, and operations and maintenance manual preparation. Legal and administration refers to effort to coordinate construction with local government agencies and facilitate land purchases and easements. Construction management is often performed by the client’s engineer and involves construction inspection, coordination of contractors, etc. As with yard piping, contractor overhead and profit were included in the cost of individual components. Discrete lines for overhead and profit are not shown in the summary tables. Construction insurance and bonds includes contractor liability coverage and performance and other bonding.

5.7.4 SOLVENT EXTRACTION FACILITY COSTS

As described previously, the solvent extraction facilities are centralized and shared by multiple algae production facilities, possibly organized as a co-op. Since solvent extractions plants are typically designed to process at least 100 mt/day of biomass, such sharing is needed to achieve economies of scale. Hauling the algae biomass to the centralized facility is assumed to take an average of 161 km for a round trip costing \$0.20/km-mt, a price from a recent study by Singh et al. (2010). The one 105-mt/d extraction facility at a capital cost of \$12,200,000 will be shared with five 100-ha algae facilities (Table 5.10). The capital cost attributed to each algae facility is \$2,430,000. Operational costs are also shared at \$478,000/yr per 100-ha algae facility (Table 5.10). The larger 4,000-mt/d extraction facilities have a capital cost of \$33,300,000, but the cost is shared by fifty 400-ha algae facilities. Therefore, each algae facility shares 2% of the capital and operating costs, as shown in Table 5.10.

Table 5.10: Extraction facility total and shared operational and capital costs

	Extraction Plant with 105 mt/d of Feed	Extraction Plant with 4,000 mt/d of Feed
Electrical Cost (\$/yr)	\$85,100	\$1,600,000
Heating Cost (\$/yr)	\$275,000	\$7,980,000
Administration Cost	\$332,000	\$332,000
Operator Cost (\$/yr)	\$1,700,000	\$1,700,000
Total Operational Cost (\$/yr)	\$2,390,000	\$11,600,000
Percentage Shared by One Facility	20% Sharred by One 100 ha-Facility	2% Sharred by One 400 ha-Facility
Distributed Operational Cost to One Facility (\$/yr)	\$478,000	\$232,000
Total Capital Cost For Prep and Extraction Facility (including installation and buildings)	\$12,200,000	\$33,300,000
Percentage Shared by One Facility	20% Sharred by One 100 ha-Facility	2% Sharred by One 400 ha Facility
Distributed Capital Cost to One Algae Facility (\$/yr)	\$2,430,000	\$665,000

Table 5.5 provides operation costs for the extraction plants. The extraction process is described in detail in Appendix 2.

5.7.5 DEPRECIATION: GENERIC COSTING METHOD

The model assigns each of the assets a useful life and depreciates the equipment based on the assumed useful life of the asset. The majority of the equipment is assumed to have a useful life of 20 years with the exception of the gas turbine (15 years) and vehicles (10 years). Annual depreciation is expected to decrease as the useful life expires on assets. Depreciation is assumed to be used for replacement of equipment after useful life, though in reality there is typically a residual value that could be included in a more detailed analysis. Depreciation costs are included in the 8% capital charge used throughout this study.

5.7.6 SOURCE OF CAPITAL PAYMENT TERMS: GENERIC COST METHOD

The financial model for such a wastewater treatment plant assumes that 100% of the capital cost is financed through the issuance of a bond. The payment structure on the bond assumes a consistent annual payment amount for the life of the bond. The structure of the bond is a mortgage type and will include a larger percentage of the payment being applied towards interest in the earlier years and will reduce based on the beginning principal outstanding.

A 5%, 30-year bond to fund facility construction is assumed. Only a mature, essentially risk-free technology would be financed at this rate. Further, the process would have to be inflation-neutral (income and expenses rise equally with inflation). These conditions would be applicable to the present cases where municipal wastes are treated. A further 3% per annum charge is added for depreciation on total facility cost, based on an average of the different useful lives of the various depreciable assets. A combined capital charge of 8% is thus used in this report's financial analysis. At the end of the 30-year bond term, the plant would be fully amortized, debt-free, and with sufficient funding set aside for complete renovation.

5.7.7 OPERATORS AND ADMINISTRATION

The operational requirements of the 100-ha facilities are similar to those of a normal wastewater treatment plant. The facility is projected to be staffed by a plant manager, a supervisor of operators, a lab manager, and an administrative assistant, for a total salary cost of \$375,000, including benefits (Table 5.11). Operators of different skill levels are required, depending on the equipment or operation that they work with. It is estimated that a total of 14 full time operators will be required. With an average salary of \$41,100 per year and benefits at 30%, the annual cost per year is \$748,000 Case 1 (Table 5.12). The number of operators is reduced to 11 for Case 2 because there are reduced labor needs by not having drying beds,

other drying equipment, and the export of biomass offsite (discussed below). This estimate does not include any costs such as corporate overheads, R&D and technology licenses, legal and accounting, sales and marketing, etc.

Table 5.11: Administrative personnel costs for a 100-ha facility

Admin Costs	\$/yr
Plant Manager	114,000
Supervisor of Operators	93,600
Lab Manager	62,400
Admin/Secretary	17,700
Total Admin Salaries	288,000
Benefits @ 30%	86,400
Total Admin costs	\$375,000

Table 5.12: Operations personnel cost for a 100-ha facility

Operators Cost	\$/yr
Average Operator Salary	41,100
Number of Operators	14
Total Operator Salaries	575,000
Benefits @ 30%	173,000
Total Operator Costs	\$748,000

5.8 COST ANALYSIS CASE 1 AND CASE 2

5.8.1 CAPITAL COST RESULTS

Initial capital cost for the Case 1 (wastewater treatment-emphasis + oil) is about \$36 million and is broken down by unit process in Table 5.13. The majority of these costs are for the land followed by the high rate ponds and the fraction of the centralized solvent extraction facility (Table 5.10 and Figure 5.21). A graphical breakdown of capital costs is provided for Case 1 only, as an example.

Table 5.13: Capital cost for Case 1 (wastewater treatment-emphasis + oil)

Capital Cost		
Land		4,710,000
High rate ponds		3,410,000
Digesters		2,440,000
Extraction plant share ¹		2,430,000
Drying beds		2,420,000
Biogas turbine ²		2,040,000
Electrical		1,900,000
Water piping		1,660,000
Flash dryer		1,020,000
2° Clarifiers		948,000
CO ₂ delivery		594,000
1° Clarifier		420,000
Roads + Fencing		338,000
Thickeners		256,000
Buildings		120,000
Silo storage		109,000
Vehicles		100,000
Total		24,915,000
Permitting		100,000
Mobilization/demobilization	10%	2,490,000
Construction Insurance	4%	997,000
Engineering, Legal, & Administration	7%	1,740,000
Construction Management	12%	2,990,000
Contingency	10%	2,490,000
Total Capital Cost		\$35,722,000

1. Solvent Extraction cost is the share of the centralized co-op solvent extraction facility assigned to a single 100-ha algae production facility.

2. Turbines include 30% of capital cost for H₂S, selective catalytic reduction NOx control, and low-NOx flare for use during engine downtime (Spierling et al. 2009).

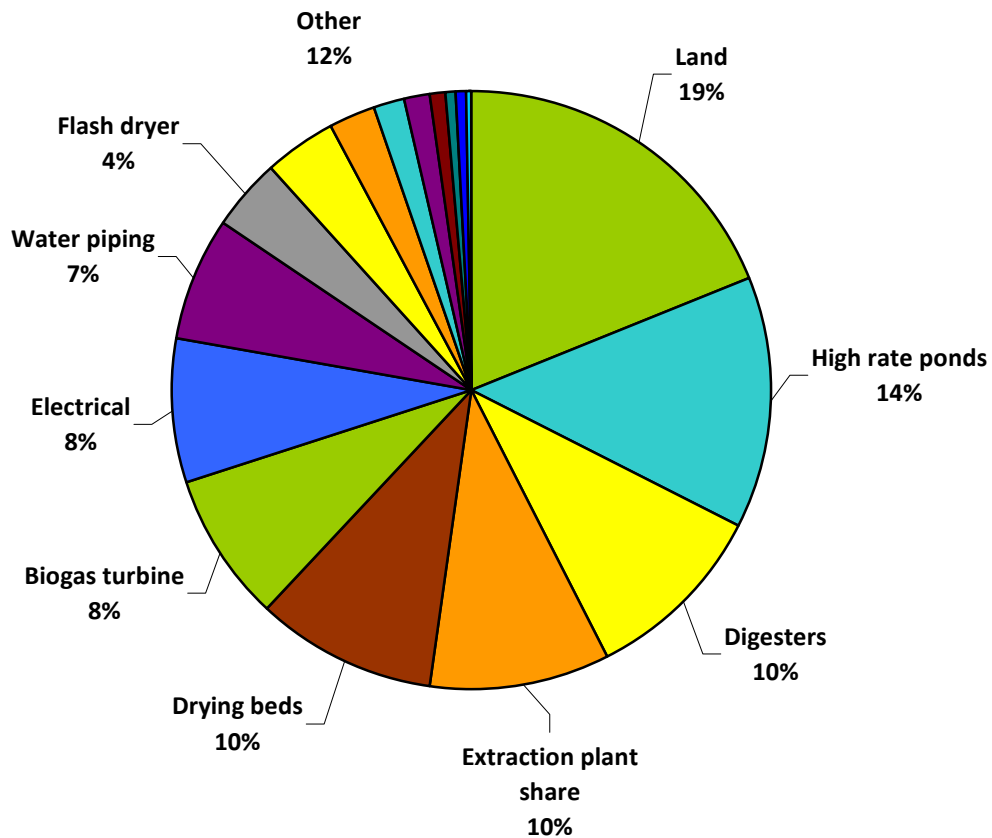

Figure 5.21: Capital cost components for Case 1 (wastewater treatment-emphasis + oil).

5.8.2 OPERATING EXPENSES AND REVENUE

Total operating expenses are assumed to remain constant throughout the model at \$3.0M per year (Table 5.14). Parasitic electricity costs are included in the operating expense to show a complete picture even though excess is produced through digestion of residuals. Income from electricity sales is estimated to be \$830,878/yr. There is no assumed revenue from the treatment of wastewater at this stage in this analysis (see later).

Table 5.14: Operating expense for Case 1 (wastewater treatment-emphasis + oil)

Operating Expenses	
Algae facility staff	\$748,000
Maintenance (2% cap.)	\$498,000
Extraction plant (staff and energy req.)	\$478,000
Electricity purchase ¹	\$358,000
Administrative staff	\$375,000
Biomass hauling ²	\$239,000
Insurance	\$180,000
Outside lab testing	\$50,000
Vehicle maintenance ³	\$15,000
Lab & office supplies	\$12,500
Employee training	\$10,000
Total Operating Expenses	\$2,960,000

1. Maintenance costs are 2% of the total capital cost (IWDP, 1991).
2. Solvent extraction costs shown are the share of the centralized co-op facility
3. Vehicle maintenance costs are 15% of the capital cost for vehicles.

5.8.3 FINANCIAL SUMMARY FOR CASE 1

Considering the cost of production on an annual basis (total cash loss, less bond repayment), the annual cost of production requirement is (\$5,299,000) per year (Table 5.15). This cost of production is divided by the oil production of 12,700 barrels/yr to give a total cost of production per barrel of (\$417) (Table 5.15).

Throughout this chapter, the cost of production excludes costs such as taxes, profits, corporate home office overheads and includes revenue from wastewater treatment fees and electricity sales.

**Table 5.15: Summary of financial model for Case 1 (wastewater treatment-emphasis + oil).
Assumes no wastewater treatment credits.**

Financial summary	
Total revenue (\$/yr)	\$831,000
Total operating expenses (\$/yr)	(\$2,960,000)
Capital charge (\$/yr)	(\$3,170,000)
Total cost of production (\$/yr)	(\$5,299,000)
Total oil produced (bbl/yr)	12,700
Total cost of production per barrel (\$/bbl)	(\$417)

5.8.4 CASE 2 COST ANALYSIS

The capital cost for Case 2 is reduced to \$26.0 million by excluding the oil extraction system and only having anaerobic digesters (Table 5.16). The original facility layout shown previously in Table 5.16 displays the needed ten individual digesters to handle all the algae biomass and supplemental carbon waste that is added.

Table 5.16: Summary of capital costs for Case 2 (wastewater treatment-emphasis + biogas)

Capital Cost		
Land		4,120,000
High rate ponds		3,410,000
Biogas turbine		2,440,000
Digesters		2,190,000
Electrical		1,900,000
Water piping		1,400,000
2° Clarifiers		957,000
CO ₂ delivery		594,000
1° Clarifier		420,000
Thickeners		256,000
Roads + Fencing		241,000
Buildings		120,000
Vehicles		100,000
Total		18,148,000
Permitting		100,000
Mobilization/demobilization	10%	1,810,000
Construction Insurance	4%	726,000
Engineering, Legal, & Administration	7%	1,270,000
Construction Management	12%	2,180,000
Contingency	10%	1,810,000
Total Capital Costs		\$26,044,000

Note: Turbines include 30% of capital cost for H₂S, selective catalytic reduction NO_x control, and low-NO_x flare for use during engine downtime (Spierling et al. 2009).

In order to predict the cost of production per kWh for a facility with the main product of electricity, the parasitic energy for the facility is excluded from the operating expenses and only net electricity exported is considered in the financial summary. Case 2 does not handle biomass to and from a centralized solvent extraction facility the number of operators is required from 14 (for Case 1) to 11. The administration staffing is kept the same. The total operating expenses are reduced to \$1.59 M/yr (Figure 5.15).

Table 5.17: Operating expense for Case 2 (wastewater treatment-emphasis + biogas)

Operating Expenses	
Algae facility staff	\$587,000
Administrative staff	\$375,000
Maintenance (2% cap.)	\$363,000
Insurance	\$180,000
Outside lab testing	\$50,000
Vehicle maintenance	\$15,000
Lab & office supplies	\$12,500
Employee training	\$10,000
Total Operating Expenses	\$1,590,000

With an annual energy production of 6,300,000 kWh and a total cost of production of (\$3,900,000)/yr, including the 30-yr bond repayment, the total cost of production is (\$0.62) per kWh (Table 5.18). Again, this does not include any revenue generated from the treatment of the wastewater.

Table 5.18: Summary of financial model for Case 2 (wastewater treatment-emphasis + biogas). Assumes no wastewater treatment credits.

Financial summary	
Total operating expenses (\$/yr)	(\$1,590,000)
Capital charge (\$/yr)	(\$2,310,000)
Total cost of production (\$/yr)	(\$3,900,000)
Total net electricity produced (kWh/yr)	6,300,000
Total cost of production per kWh (\$/kWh)	(\$0.62)

5.9 CASE 3 AND 4: BIOFUEL-EMPHASIS FACILITIES; 100-HA FACILITIES

For Cases 3, 4, and 5 wastewater is added only to make up for losses mainly due to evaporation. The required flows were summarized in Table 5.2. The only source of nutrients added to the facility come from the influent wastewater. Model analysis shows that make-up water is the limiting factor at the chosen location, not nutrient addition. The area of 100 ha was chosen to allow a comparison to the WWT cases. The facilities components designs are the same as for Cases 1 and 2, based on the same assumed hourly and daily areal algae biomass productivities (see previous Figure 5.5 and Figure 5.6).

5.9.1 ENGINEERING FACILITY DESIGN

The process flow diagram of Case 3 (biofuel-emphasis + oil) (Figure 5.22) is similar to Case 1 with the exceptions that there is no primary wastewater treatment onsite, and that the supernatant from the 2° (secondary) clarifier and the digester effluent are both recirculated back to the high rate pond to recover nutrients and reduce water demand. Primary treatment is not considered to be onsite because of the relatively low but widely varying flows that are required. It is assumed that a contract could be made with a municipal wastewater entity to receive screened wastewater from their facility on demand. Not having primary treatment onsite reduces the amount of biosolids that are generated, which in turn reduces onsite biogas generation.

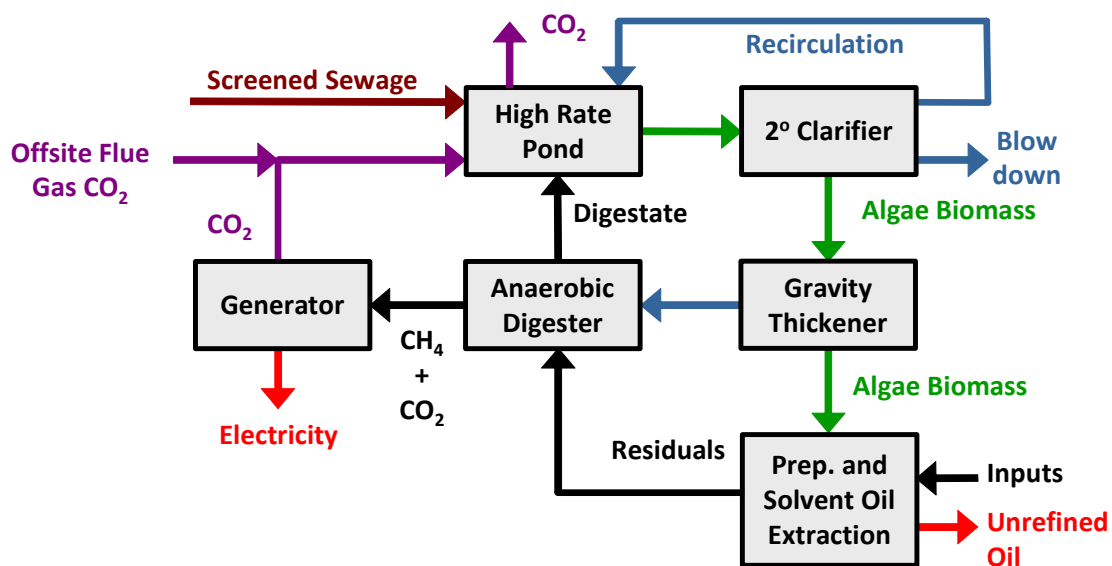

Figure 5.22: Process schematic for Case 3 (biofuel-emphasis + oil)

The process flow diagram for Case 4 (biofuel-emphasis + biogas)(Figure 5.23) has the same similarities as Case 3 to Case 1 in that there is no primary wastewater treatment onsite and that the supernatant from the 2° Clarifier and the digester effluent are both recirculated back to the high rate pond to recover nutrients and reduce water demand. The component details can be found in Section 5.6.1.

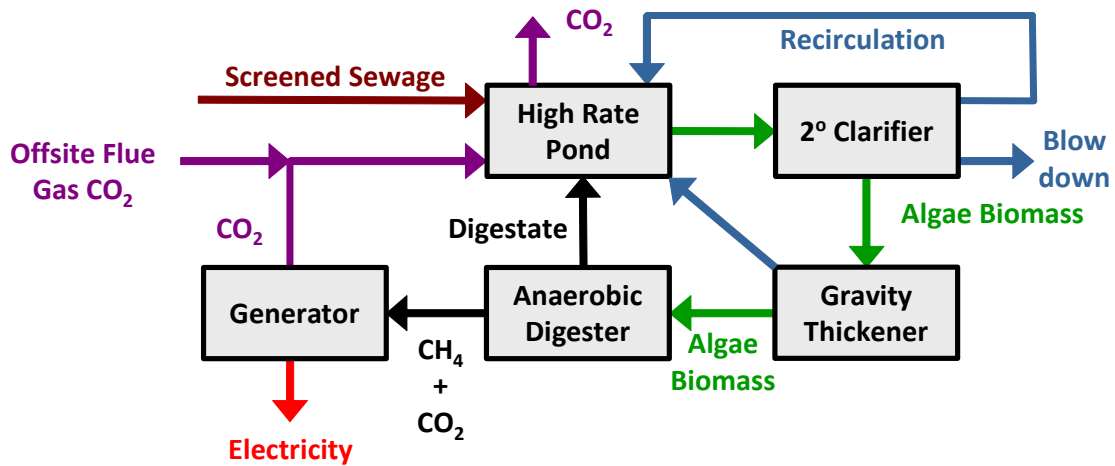

Figure 5.23: Process schematic for Case 4 (biofuel-emphasis + biogas)

5.9.2 OPERATIONS: OPERATORS, ADMINISTRATION, NUTRIENT AND CARBON BALANCE, OUTPUTS

5.9.2.1 OPERATORS AND ADMINISTRATION

The administration requirements for Cases 3 and 4 are kept the same as Cases 1 and 2. However, the operators required can be reduced slightly due to lack of primary treatment at the facility. Therefore, Cases 3 and 4 are assumed to have 13 and 10 full-time employees, respectively. Again, Case 4 requires fewer operators because it only has anaerobic digestion onsite and there is no biomass drying required. All salaries are assumed to remain the same.

5.9.2.2 NUTRIENT AND CARBON BALANCE

Upon analysis of the losses due to evaporation and the make-up wastewater that would be added, it was determined that all the make-up nutrients required for algae biomass production would be provided with this make-up water. For Case 3, there is a greater need for CO₂ that is not produced from combustion of biogas onsite, equivalent to a 4.4 MWe power plant at peak summer demand (Figure 5.24 and Figure 5.25). It is assumed that this flue gas is imported into the algae farm site.

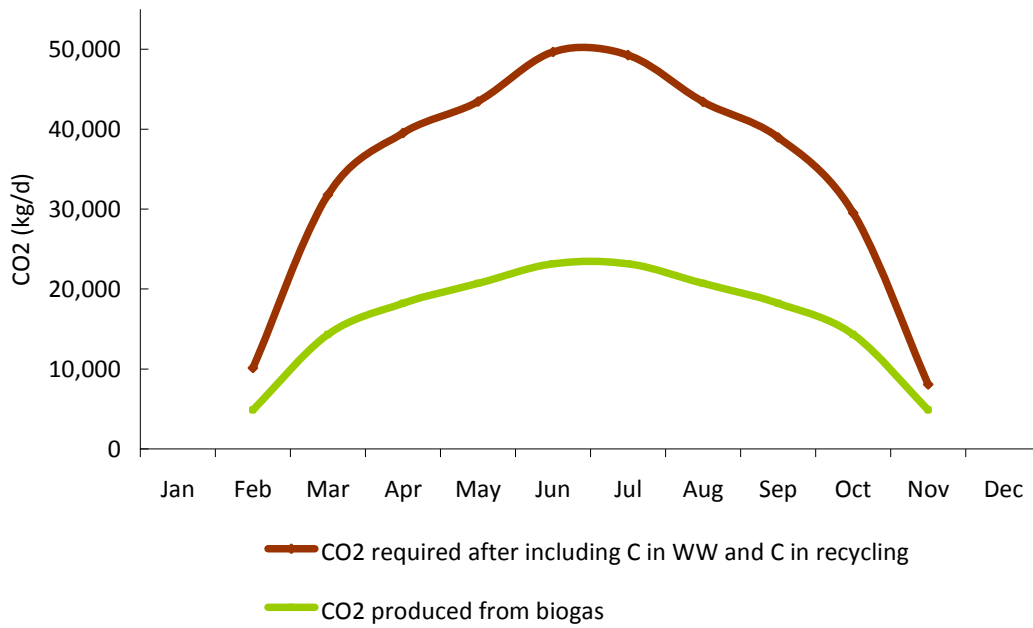

Figure 5.24: Case 3 CO₂ requirement and CO₂ produced onsite. The requirement accounted for carbon in wastewater and recycling of carbon from digester effluent and 2° clarifier supernatant.

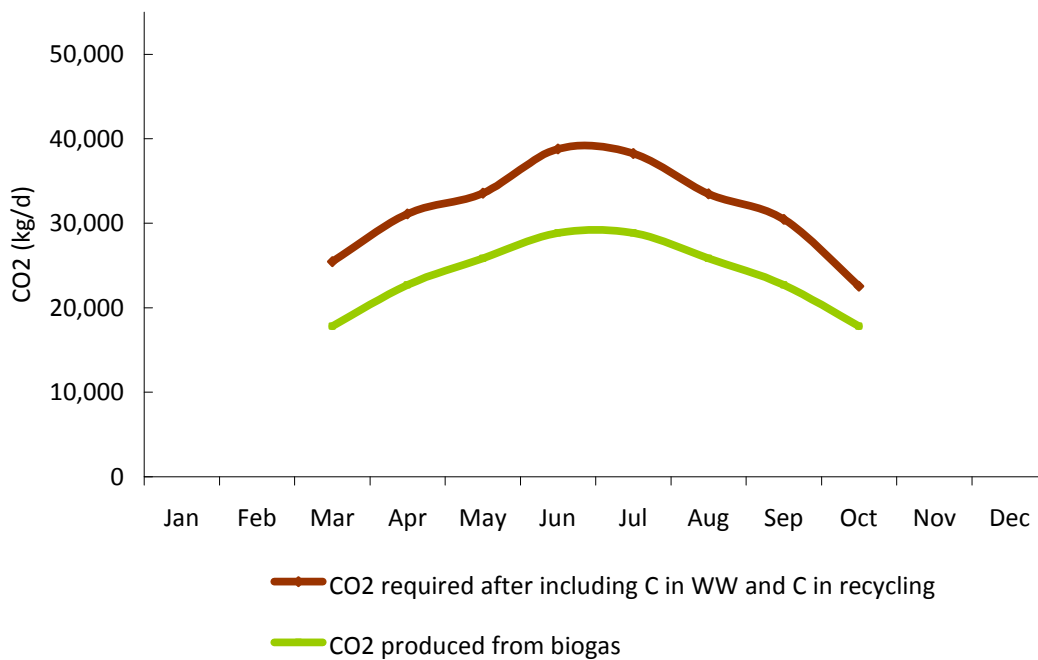

Figure 5.25: Case 4 CO₂ requirement and CO₂ produced onsite. Requirement accounted for carbon in wastewater and recycling of carbon in digester effluent, 2° clarifier supernatant, and gravity thickener supernatant.

5.9.2.3 OUTPUTS

The total makeup water that is provided to Cases 3 and 4 is 3,390 and 2,820 ML/yr, respectively (Table 5.19). Note that Case 4 produces less harvested biomass (6,760 mt/yr) versus Case 3 (7,200 mt/yr) due to the facility being shut down for more months per year, further discussed below. The comparison of total energy produced by Cases 3 and 4 is similar to the comparison of Cases 1 and 2 in that the oil producing case produces more energy. However, both Cases 3 and 4 produce total less gross energy at $139,000 \times 10^3$ and $79,100 \times 10^3$ MJ/yr than Cases 1 and 2 (Table 5.19) -- a difference of $34,000 \times 10^3$ and $37,900 \times 10^3$ MJ/yr, respectively. In contrast, the energy produced per volume make-up water is higher than Cases 1 and 2, at 40,800 and 28,000 MJ/ML for Cases 3 and 4, (Table 5.19), a difference of 33,190 and 22,860 MJ/ML, respectively.

Table 5.19: Gross energy production for Cases 3 and 4

Case	Influent (ML/yr)	Harvested Biomass (mt/yr)	Biofuel Type	Product Quantities	10^3 MJ/yr	MJ/mt algae	MJ/ML WW influent
3	3,390	7,200	Oil	12,300 bbl/yr	71,100	9,870	20,900
			Biogas	1,730,000 m ³ CH ₄ /yr	67,600	9,390	19,900
			Sum		139,000	19,300	40,800
4	2,820	6,760	Biogas	2,030,000 m ³ CH ₄ /yr	79,100	11,700	28,000

The total amount of oil produced for Case 3 is 1,960,000 L/yr or 12,300 barrels/yr. However, this oil is not extracted onsite, and similar to Case 1, the biomass is first stored in silos onsite. It is then combined with the biomass from four other 100-ha facilities in a steady stream to a centralized 105-mt/d extraction facility, which produces a total of 168 bbl/d from that biomass (Figure 5.26). This spent algae biomass is then sent back to silo storage where it can be fed to digesters, with their effluent discharged to the ponds depending on pond carbon demand.

Unlike Case 1, Case 3 imports net electricity for the months of November through February. The productivity is too low to operate the facility in December and January. However, despite the electrical consumption in November and February (2 MWh/d), the facility still has positive revenue, and therefore the facility is kept open. Over the year, the net electrical energy produced onsite from biogas production ranges from -2 to 11 MWh/d, totaling 4,780,000 kWh/yr (Figure 5.26).

Similar to Case 3, Case 4 would need to import electrical energy through the months of November through February. However, unlike Case 3, there is no oil revenue to justify operation, and thus the facility is shut down during these 4 months.

Case 4 produces excess energy ranging from 10 to 17 MWh/d and a total of 3,770,000 kWh/yr from biogas production for 8 months of operation per year. The only other output would be occasional blow down of the salt accumulated in the system, but that is not considered to be substantial enough to require adding a specific cost estimate for blow down disposal ponds.

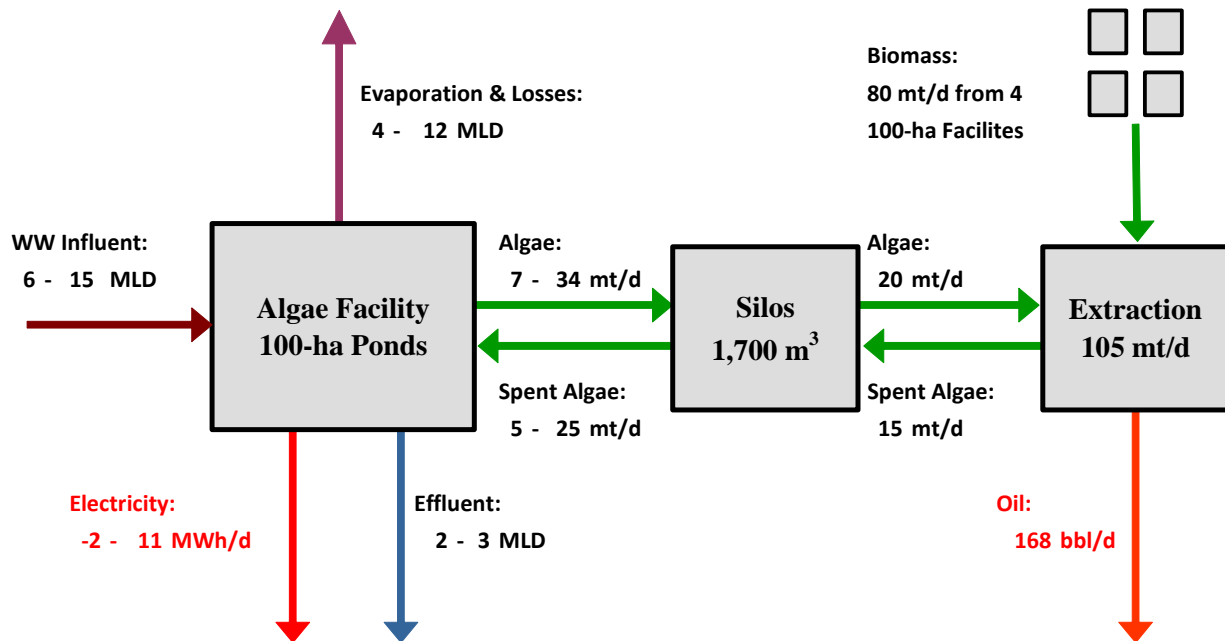

Figure 5.26: Simplified mass balance for Case 3 (biofuel-emphasis + oil), showing seasonal variations

Note: This figure does not show the additional flue gas from a natural gas burner or generator that is imported (e.g., from a 0.5 – 4.4 MW generator) to satisfy algae carbon demand.

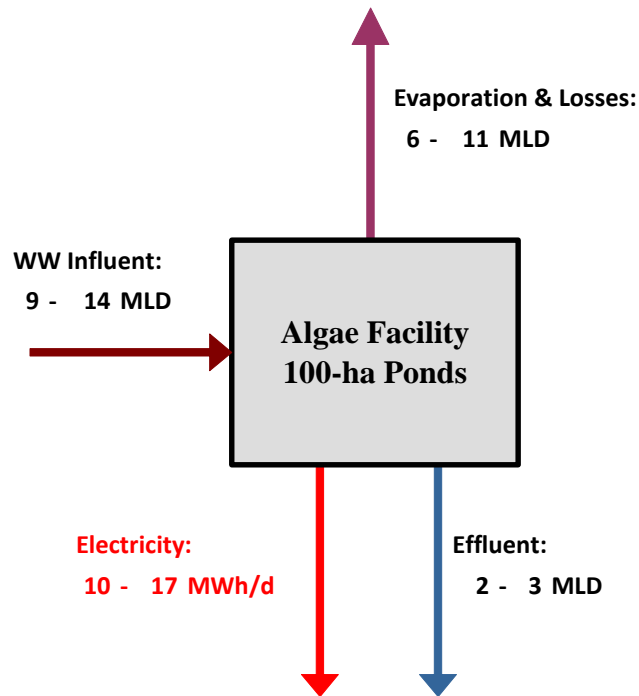

Figure 5.27: Simplified mass balance for Case 4 (biofuel-emphasis + biogas), showing seasonal variations.

Note: This figure does not show the additional flue gas from a natural gas burner or generator that is imported (e.g., from a 0.8 – 1.7 MW generator) to satisfy algae carbon demand.

5.9.3 CASE 3 COST ANALYSIS

The total capital cost for Case 3 is \$30.6 million (Table 5.20), which is less than Case 1 at \$35.7 million, mainly due to the absence of primary settling and primary digestion onsite. Additionally, land costs are reduced from \$30,000 to \$15,000/ha, attributed to Cases 1 and 2 requiring large wastewater flows, thereby necessitating a closer proximity to large municipalities. For Cases 3 and 4, it is predicted that since the facility is only receiving and not discharging wastewater, and these flows are relatively smaller, the facility could be further from the wastewater source or larger population centers, thereby reducing land costs.

Table 5.20: Summary of capital costs for Case 3 (biofuel-emphasis + oil)

Capital Cost		
High rate ponds		3,410,000
Digesters		2,150,000
Extraction plant share		2,430,000
Drying beds		2,420,000
Land		2,350,000
Electrical		1,900,000
Water piping		1,590,000
Biogas turbine		1,620,000
Flash dryer		1,020,000
2° Clarifiers		936,000
CO ₂ delivery		594,000
Roads + Fencing		338,000
Thickeners		255,000
Buildings		120,000
Silo storage		109,000
Vehicles		100,000
Total		21,342,000
Permitting		100,000
Mobilization/demobilization	10%	2,130,000
Construction Insurance	4%	854,000
Engineering, Legal, & Administration	7%	1,490,000
Construction Management	12%	2,560,000
Contingency	10%	2,130,000
Total Capital Cost		\$30,606,000

With a total revenue per year of \$554,000 /yr from onsite electrical generation and with an operating expense of (\$2,810,000)/yr and a bond repayment of (\$2,720,000)/yr, the total cost of production is (\$4,976,000)/yr (Table 5.21). With the 12,300 bbl/yr produced a total cost of production of (\$405)/bbl is calculated (Table 5.21). In this case there would be relatively smaller wastewater treatment credits than Case 1, and the net cost of the oil is much higher, due in part to the lower revenue from anaerobic digestion.

Table 5.21: Summary of financial model for Case 3 (biofuel-emphasis + oil)

Financial summary	
Total revenue (\$/yr)	\$554,000
Total operating expenses (\$/yr)	(\$2,810,000)
Capital charge (\$/yr)	(\$2,720,000)
Total cost of production (\$/yr)	(\$4,976,000)
Total oil produced (bbl/yr)	12,300
Total cost of production per barrel (\$/bbl)	(\$405)

5.9.4 CASE 4 COST ANALYSIS

The total capital cost for Case 4 is \$21.3 million (Table 5.22), which is less than Case 2 at \$26.0 million due to the same reasons described for Case 3.

Table 5.22: Summary of capital costs for Case 4 (biofuel-emphasis + biogas)

Capital Cost		
High rate ponds		3,410,000
Land		2,060,000
Biogas turbine		2,010,000
Digesters		1,900,000
Electrical		1,900,000
Water piping		1,320,000
2° Clarifiers		936,000
CO2 delivery		594,000
Thickeners		255,000
Roads + Fencing		241,000
Buildings		120,000
Vehicles		100,000
Total		14,846,000
Permitting		100,000
Mobilization/demobilization	10%	1,480,000
Construction Insurance	4%	594,000
Engineering, Legal, & Administration	7%	1,040,000
Construction Management	12%	1,780,000
Contingency	10%	1,480,000
Total Capital Cost		\$21,320,000

With an operating expense of (\$1,470,000)/yr and a capital charge of (\$1,890,000)/yr, the total cost of production is (\$3,360,000)/yr (Table 5.23). With the 3,770,000 kWh/yr produced a total cost of production of (\$0.89)/kWh is calculated (Table 5.23). This is greater than Case 2 at (\$0.62)/kWh. Additionally in this case, the wastewater treatment credit would be greatly reduced because of the reduced flow of wastewater influent and treated effluent.

Table 5.23: Summary of financial model for Case 4 (biofuel-emphasis + biogas)

Financial summary	
Total operating expenses (\$/yr)	(\$1,470,000)
Capital charge (\$/yr)	(\$1,890,000)
Total cost of production (\$/yr)	(\$3,360,000)
Net electricity produced (kWh/yr)	3,770,000
Total cost of production per kWh (\$/kWh)	(\$0.89)

5.10 CASE 5: BIOFUEL-EMPHASIS + OIL, 400 HA

For the design of Case 5, the total area of algae ponds was increased to 400 hectares. The basic layout for the 100-ha facility was assumed to be expanded into four modules of 100 ha each. All operating parameters were kept the same as Case 3. The number of operators was quadrupled. However, the staffing requirement for the administration was kept the same. The administrative work load is assumed to be nearly the same as for the 100-ha facilities. The only other difference compared to Case 3 is that the centralized oil extraction facility capacity was increased to handle 4,000 mt/d, which are shared between 49 other 400-ha algae facilities. The shared energy demand and staffing requirements of this larger solvent facility are lower than Case 3, discussed previously in Section 5.7.4. These are the only savings attributed to the larger 400-ha facility over the smaller Case 3. With a total influent of 13,60013,600 ML/yr and a harvested biomass of 28,90028,900 mt/yr, the gross energy produced for Case 5 is 556,000 x 10³ MJ/yr when considering both oil and biogas (Table 5.24). This is the same yield of energy of 19,300 MJ/mt (or 40,800 MJ/ML) as Case 3 (Table 5.24 vs. Table 5.19).

Table 5.24: Gross energy production for Case 5 (biofuel-emphasis + oil, 400 ha)

Case	Influent (ML/yr)	Harvested Biomass (mt/yr)	Biofuel	Product Quantities	10 ³ MJ/yr	MJ/mt	MJ/ML
5	13,600	28,900	Oil	49,300 bbl/yr	285,000	9,870	20,900
			Biogas	6,950,000 m ³ CH ₄ /yr	271,000	9,390	19,900
			Sum		556,000	19,300	40,800

The required wastewater influent to make up for evaporation and losses ranges by season from 23 to 59 MLD (Figure 5.28). The algae biomass produced from the facility ranges from 28 to 135 mt/d, which is then stored in silo storage to create a steady stream of 79 mt/d of biomass. This biomass is combined with that from 49 other algae facilities to create a total flow of 4,000 mt/d, which is then processed for oil extraction (Figure 5.28). The oil extraction facility produces 6,753 bbl/d, and a spent biomass flow of 59 mt/d is sent back to each individual algae facility for storage where it can be digested, with the carbon returned to the algae ponds at a rate depending on the carbon demand (Figure 5.28).

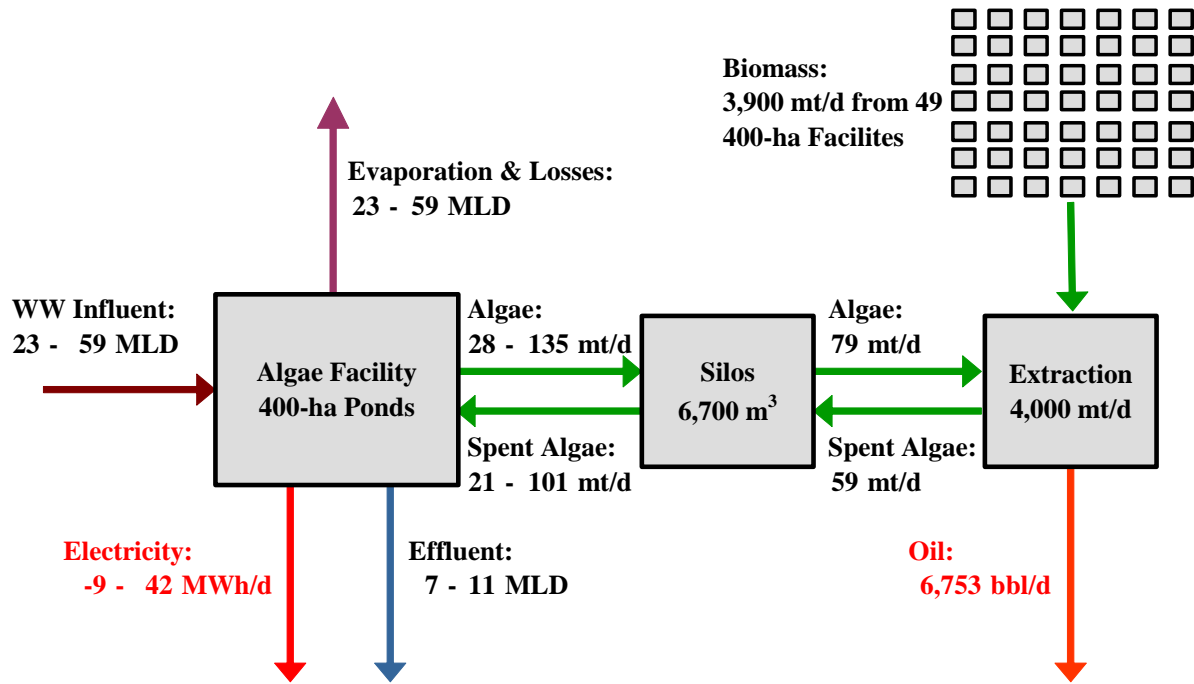

Figure 5.28: Simplified mass balance for Case 5 (biofuel-emphasis + oil, 400 ha), showing seasonal variations.

Note: This figure does not show the additional flue gas from a natural gas burner or generator that is imported (e.g., from a 2.0 – 18 MW generator) to satisfy algae carbon demand.

To illustrate the envisioned process in more detail and assist in its evaluation, a detailed mass balance for Case 5 is shown in Figure 5.29. The mass balance includes water, biomass, nitrogen and carbon. Details such as the loss of water and ammonia nitrogen from the ponds and drying beds can be seen. Minor masses such as solvent loss are not shown.

For Case 5, the total capital cost required is \$101.6 million (Table 5.25). As described above, most of the costs were taken from Case 3 and multiplied by four to reflect the increase in pond area. One of the cost savings from Case 3 is the reduced share of the solvent extraction facility capital. In Case 5, the larger extraction facility is shared with 49 other 400-ha algae facilities, decreasing the cost per algae facility from \$2,430,000 to \$665,000 .

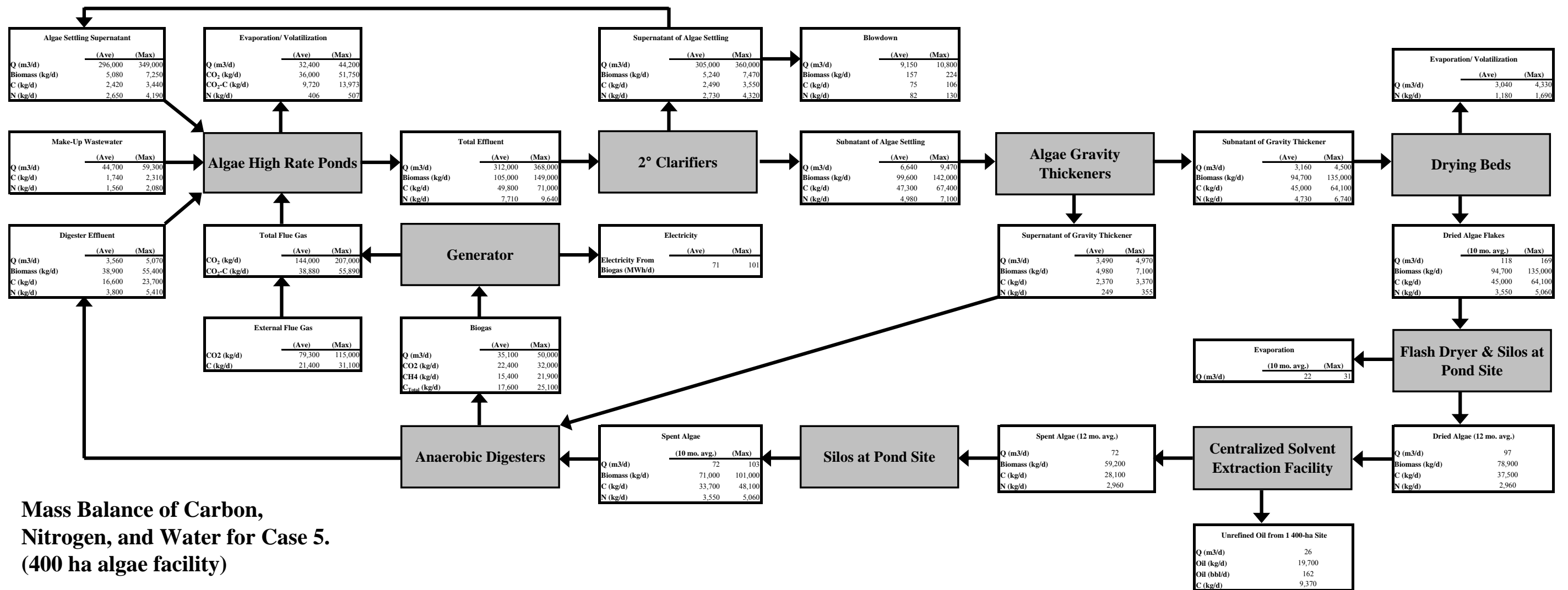

Figure 5.29: Water, biomass, and nutrient mass balance for Case 5. Annual average and maximum flows are shown.

Note: Figure is formatted for 11" x 17" page size. The algae facility operates 10 months per year, but the extraction facility operates 12 months per year. Therefore, average flows going into and out of storage silos are on a 12 or 10 month average basis. Natural gas inputs for flash dryer and solvents for centralized solvent extraction facility are not shown.

Table 5.25: Summary of capital costs for Case 5 (biofuel-emphasis + oil, 400 ha)

Capital Cost		
High rate ponds		13,600,000
Drying beds		9,690,000
Land		9,410,000
Digesters		8,620,000
Electrical		7,600,000
Biogas turbine		6,480,000
Water piping		6,370,000
2° Clarifiers		3,750,000
CO ₂ delivery		2,380,000
Flash dryer		2,070,000
Roads + Fencing		1,350,000
Thickeners		1,020,000
Extraction plant share		665,000
Buildings		480,000
Silo storage		470,000
Vehicles		400,000
Total		74,355,000
Permitting		100,000
Mobilization/demobilization	3.5%	2,600,000
Construction Insurance	4%	2,970,000
Engineering, Legal, & Administration	7%	5,200,000
Construction Management	12%	8,920,000
Contingency	10%	7,440,000
Total Capital Cost		\$101,585,000

With a total revenue per year of \$2,220,000 /yr from onsite electrical generation, an operating expense of (\$8,090,000)/yr, and a capital charge of (\$9,020,000)/yr, the total cost of production is (\$14,890,000)/yr (Table 5.26). With the 49,300 bbl/yr produced, a total cost of production of (\$302)/bbl is calculated (Table 5.26). This cost is less than both Cases 1 and 3 due mainly to the lower administrative staff and oil extraction costs.

Table 5.26: Summary of financial model for Case 5 (biofuel-emphasis + oil, 400 ha)

Financial summary	
Total revenue (\$/yr)	\$2,220,000
Total operating expenses (\$/yr)	(\$8,090,000)
Capital charge (\$/yr)	(\$9,020,000)
Total cost of production (\$/yr)	(\$14,890,000)
Total oil produced (bbl/yr)	49,300
Total cost of production per barrel (\$/bbl)	(\$302)

5.11 COST COMPARISON AND ANALYSIS SENSITIVITIES

A summary of all the cases is presented in Table 5.27. The wastewater cases have slightly higher capital costs due to the onsite primary treatment that is omitted from the biofuels cases. However, having primary treatment allows primary sludge to be digested, increasing electricity production. Oil production by the biofuel-emphasis Case 3 is slightly less than the wastewater-emphasis Case 1 because the Case 3 plant would not be operated during winter. The wastewater treatment cases will have a higher credit for wastewater treatment (see below), which explains the lower cost per kWh for Case 2 compared to Case 4. The lower operating expenses and capital costs lead to the lower cost per barrel when comparing Cases 1 to 3. Case 5 at 400 ha has the greatest potential for the amount of oil that can be produced and can also achieve the lowest cost per barrel at (\$302)/bbl.

Table 5.27: Financial summary for individual case studies. No credit for wastewater treatment is considered in this table.

Case	Area	Emphasis	Biofuel	Product quantity	Capital cost (\$ million)	Operational cost (\$ million/yr)	Cost of production
1	100 ha	Wastewater Treatment	Oil	12,700 bbl/yr	\$36	\$3.0	(\$417) /bbl
2	100 ha	Wastewater Treatment	Biogas	6,300 MWh/yr	\$26	\$1.6	(\$0.62) /kWh
3	100 ha	Biofuel Production	Oil	12,300 bbl/yr	\$31	\$2.8	(\$405) /bbl
4	100 ha	Biofuel Production	Biogas	3,770 MWh/yr	\$21	\$1.5	(\$0.89) /kWh
5	400 ha	Biofuel Production	Oil	49,300 bbl/yr	\$102	\$8.1	(\$302) /bbl

To analyze the revenue that could be generated for wastewater treatment for the individual cases, biochemical oxygen demand (BOD) removal was calculated. Fees for wastewater treatment vary widely, but assuming a typical municipal revenue of \$1.23/kg BOD removed (AMSA, 2002), the range of revenues that can be generated is \$627,000 for Case 4, which receives the lowest influent flow, to \$4,950,000 for Cases 1 and 2, which receive the highest

influent flows (Table 5.28). Including this revenue, the final cost of production for Case 1 decreases to (\$28)/bbl from (\$417)/bbl (Table 5.28). The Case 2 cost of production becomes positive at \$0.17 /kWh, with greater revenue than costs. The biofuel-emphasis Cases 3 through 5 still have negative costs of production, but they improve to (\$332)/bbl for Case 3, (\$0.72)/kWh for Case 4, and (\$240)/bbl for Case 5 (Table 5.28).

Table 5.28: Total cost of production when including wastewater treatment revenue from BOD removal.

Case	Area	Emphasis	Biofuel	Cost of production w/o wastewater treatment credit	Wastewater treatment revenue (\$/yr)	Overall cost of production w/ treatment revenue
1	100 ha	Wastewater Treatment	Oil	(\$417) /bbl	\$4,950,000	(\$28) /bbl
2	100 ha	Wastewater Treatment	Biogas	(\$0.62) /kWh	\$4,950,000	\$0.17 /kWh
3	100 ha	Biofuel Production	Oil	(\$405) /bbl	\$754,000	(\$332) /bbl
4	100 ha	Biofuel Production	Biogas	(\$0.89) /kWh	\$627,000	(\$0.72) /kWh
5	400 ha	Biofuel Production	Oil	(\$302) /bbl	\$3,030,000	(\$240) /bbl

Among the 100-ha facilities, production of oil (Cases 1 and 3) added considerable expense compared to production of biogas only (Cases 2 and 4). Capital costs are 30-40% higher and operating costs approach 100% higher due to the additional facilities needed for the oil producing cases. The 400-ha Case 5 has only a 3.3-fold higher capital cost than the analogous 100-ha Case 3, indicating the economy of scale. Similarly, the Case 5 operating costs are only 2.9-times greater than those of Case 3.

Cases 1 and 2, with biofuels production as a byproduct of wastewater treatment, are highly favorable economically in this analysis. Case 1 results in a cost of production that is about a third of current petroleum oil prices. Case 2 (biogas only) achieves positive net revenue without any income from the sale of biogas-derived electricity, meaning that the wastewater treatment revenues more than cover the capital and operating costs of the facility. However,

these results are highly sensitive to any changes in costs or revenues, because total costs nearly equal total revenue for Cases 1 and 2.

The economics are not favorable for Cases 3 and 4, where wastewaters are only supplementary to biofuel production and, thus, wastewater treatment credits are much smaller (less than 15% of Cases 1 and 2). However, even this small amount of credit reduces oil or electricity costs by about 20%.

To achieve break-even for Cases 3 and 4, oil would need to be sold for \$332/barrel and electricity for \$0.72/kWh, both far higher than current prices. Although renewable energy and greenhouse gas abatement credits may be available for such a process, these are speculative at this time and, in any event, would not be sufficient at current levels to make such a process economic. For Case 5, which is similar to Case 3 but four-times larger (400 ha), economies of scale reduce the cost of production by a quarter, to \$240/barrel, still much too high for current or foreseeable economics of renewable biofuels, even including greenhouse gas credits.

Additional tables giving side-by-side comparisons of all the cases are provided in the Executive Summary.

CHAPTER 6. CONCLUSIONS AND R&D RECOMMENDATIONS

6.1. BIOFUELS AND CO-PRODUCTS

The main conclusion from this report is that oil production with microalgae will be expensive, even with relatively favorable process assumptions (e.g. low cost system designs, high productivity algae cultivation, high oil content, low cost harvesting and processing).

Although only wastewater treatment was considered extensively as a potential co-product, other opportunities can be considered, such as animal feed co-production along with the algae oil. Indeed, most current projects in algae biofuels use animal feeds co-production to improve their projected bottom lines. However, using the biomass residue remaining after oil extraction for animal feeds would not add greatly to the bottom line where drying was not already being done to allow for solvent extraction. Extensive analysis of animal feed production is beyond the scope of this study.

Another popular option is to combine algae biofuel production with higher value co-products, also advocated by many promoters in this field. For example, *Haematococcus pluvialis* is grown for the production of astaxanthin, a high value (~\$2,000/kg) red colorant used in large amounts (about 200 tons) to color salmon in the aquaculture industry. With a content of 2% astaxanthin in the *H. pluvialis* biomass and possibly a 20% oil content, up to 10,000 tons of biomass and 2,000 tons (or more) of oil could be produced for this market. With the *H. pluvialis* biomass having a value of \$40,000 per ton, it should not be a major challenge to produce, extract the color and sell the residual oil for biofuel. Indeed, last year residual oil from *H. pluvialis* was used for production of jet fuel in a Continental flight test. However, it may be noted that currently the only market for astaxanthin from *H. pluvialis* is in nutraceuticals, where it has an even higher value (~\$20,000/kg), though much smaller market (~2 tons). More importantly, if production costs were reduced to compete in the salmon colorant market (now dominated by the much cheaper synthetic astaxanthin), there would be no reason not to use the entire biomass, rather than just the extracted pigment, as feed. In any event, the market would be limited to one or two biofuels production plants of minimum scale. In conclusion, specialty animal feeds do not provide a realistic co-product option to algae biofuel production.

6.2. THE CURRENT STATE OF THE ALGAE BIOFUELS INDUSTRY

The algae biofuels industry is still in its early gestation. As reviewed earlier, current commercial algae biomass production is restricted to high value nutritional products, which in the US is represented mainly by two companies, Earthrise Nutritionals, LLC in California and Cyanotech Corp. in Hawaii. Together they operate about 40 ha of algae ponds, both using the standard paddle wheel mixed raceway designs generally now used for algae mass cultivation. In Hawaii,

Fuji Chemicals also operates a dome-type photobioreactor plant (Figure 2.8), which produces perhaps one or two tons of algae biomass (*Haematococcus pluvialis* for astaxanthin) per year, but this is not of further interest in this discussion. A number of wastewater treatment plants use algae ponds and harvest algae from these with chemical flocculants, in California perhaps for a total of close to 1,000 hectares. However, the algae biomass-flocculant mixture produced is not used beneficially, due to difficulties of handling such a waste (see Section 2).

Despite the scores, if not over a hundred, companies in the US, and more abroad, now in this field, there are as yet (mid-2010) no pilot plants (>100 mt algae biomass/yr) for autotrophic algae biofuels production operating in the US or elsewhere. Even the few pre-pilot-scale (e.g. >10 mt) plants have operated for less than a year, with only rather smaller operations of a few hundred square meters operating for two or more years (e.g., Seambiotics in Israel and Aurora Biofuels in Florida). The total output from all experimental facilities over the past year was only a few tons of biomass and less than a hundred gallons of actual algae oil, if that much. Although a number of companies have announced projects of various scales to be initiated over the next year, it is premature to anticipate any actual results, in either production, information, or results, from such activities. However, three fairly advanced US projects for algae oil production can be mentioned: Cellana Co. of Hawaii, Sapphire Energy of San Diego, and General Atomics, also of San Diego. It is instructive to briefly discuss the current status of each of these projects, all of which use the same raceway, paddle wheel mixed pond design used in the present report, and by most commercial algae companies.

Cellana Co. in Hawaii (a joint venture of Shell Oil Co. and H.R. Biopetroleum, Inc.) has operated a pre-pilot plant, reportedly about one hectare of ponds growing diatoms, near Kona, Hawaii, for less than a year. The technology (see Huntley and Redalje, 2007) was based on prior experience with production of *Haematococcus pluvialis* biomass by Aquasearch Co., in Hawaii, even though that company failed after over \$30 million in investment. (Cyanotech Co., using the same technology, established a commercial facility, selling \$7 million of astaxanthin over the past year). The basis of the Cellana project was a projected average productivity of 50 g/m²-day, and the future of this project might well hinge on achieving such a high bar. H.R. Biopetroleum announced, already two years ago, plans for a much larger project in Hawaii, but Cellana (and Shell Oil Co.) has been more reticent about any future plans. The investment in Cellana has not been disclosed, but is likely in the tens of millions of dollars.

A company that is on a fast track to a full-scale demonstration plant is Sapphire Energy of San Diego. Sapphire is operating a pre-pilot plant in New Mexico, also initiated less than a year ago. It was awarded over \$100 million in US government grants and loans and has announced that it will start construction in the coming year of a 300-acre demonstration plant. Sapphire initially announced that it would produce algae oil with oil-excreting GMA (genetically modified algae), but more recent announcements seem to indicate that the company has backed away from such an approach and now intends to follow the standard model of growing, harvesting and processing “native” algae with a high oil content.

General Atomics, in San Diego, has received over \$30 million from the US Department of Defense (DARPA) to develop low-cost (\$3/gallon initially, \$1/gallon later) technology for microalgae oil production in a two-phase, 36-month R&D effort. Phase 1, now completed, was for 18 months and is now to be followed by a further 18 months (reportedly in Hawaii, this is just starting). It is not clear what scale of ponds General Atomics has operated, on their own or with various partners in the US or elsewhere, but they reportedly produced much of the algae biomass required under their DARPA contract at the Carbon Capture Corp. facility near the Salton Sea (discussed in Section 2). It is known that the project requires significant animal feed co-product credits to approach the \$3/gallon requirement.

All three companies are compressing the R&D phase of their projects and are already pushing towards a demonstration phase. It might be argued that the key employees have sufficient experience from prior projects to allow for such a fast track to scale-up. However, as just pointed out, the only experience in this field relates to laboratory and pre-pilot scale projects for biofuels production. The commercial production experience relates to high-value products, which are hundreds to thousands of times more valuable than biofuels. The state-of-the-art in this field is wanting in almost all respects, from the ability to achieve long-term culture stability (e.g., avoiding algae weeds from taking over, grazers from decimating the cultures), to high productivities (even 50 mt/ha-yr with a 25% oil content is a forward looking projection), to low-cost harvesting (remains to be developed), to extraction and processing of the oil. Certainly, it is possible to build large ponds and grow algae, but it remains to be demonstrated that it is possible to mass culture algae within the technical and economic constraints required for biofuels production, or even animal feeds. Thus, any rush to even pilot projects, let alone demonstration plants, may well be premature and will have an inherently high risk of failure.

Of course, some will argue that this is too pessimistic a conclusion. Perhaps the various groups have sufficient undisclosed information to warrant advancing rapidly to the goal of algae oil production at acceptable costs. Further, the argument can be made that the enormous amount of research now being funded, both in the US and around the world, in all aspects of algae biofuels production will soon solve most of the outstanding issues. This acceleration will shortly translate into commercial, or at least pilot- and demonstration-scale, successes. For one example only, the US government recently awarded a \$44 million contract to a consortium of organizations (National Alliance for Advanced Biofuels and Bioproducts, NAABB) which aims in three years to advance algae oil production technology to a commercial reality. Thus, the argument might be that even the above mentioned companies, and many others not discussed, will be well positioned to quickly exploit such R&D advances, soon to be made by these and many other researchers. Of course, this assumes that R&D will be quick, something that prior experience does not suggest.

6.3. R&D NEEDS AND TIME FRAME

To counterbalance this perspective, it can be noted that some organizations take a longer range view of this technology: Shell Oil and Exxon-Mobil recently mentioned that 10 years would be required to develop this technology. (It may be parenthetically noted, however, that Shell had a faster track in mind when it initiated the Cellana joint venture.) The Carbon Trust in the UK,

which initiated a ~\$30 million program, is also projecting a ten-year effort. Others (e.g., researchers at NREL) have suggested similar timelines. Ten years is a short time for development of any novel technology, but a very long-term for a venture capital fund, which typically requires a high return on investment within three to five years. This perhaps explains the differences between the venture-backed firms and projects funded by larger companies and governmental organizations, which may be able to take a somewhat longer view.

From the present report, it is clear that algae biofuels technology still requires considerable R&D, with the exception of niche applications, such as in wastewater treatment, which should require less research. Thus, the building of 100-hectare demonstration plants, with investments of tens to hundreds of millions of dollars, are premature. This does not mean that projects focused on the operation of open ponds should not be considered: indeed algae mass cultivation and harvesting technologies cannot be developed in the laboratory. Only through intensive, continuous, eventually large-scale research with outdoor ponds can we hope to achieve progress in any reasonable time frame: Intensive in terms of data collection, including both biotic and environmental parameters. Continuous means every day, every month, multiple years, and multiple locations; and large-scale in terms of the numbers of ponds and their sizes. For research, it is better to operate many smaller ponds than a few large ones. Of course, ponds should be of sufficient size to provide robust data, minimization of edge effects, and allow for extrapolation to larger scales. And some operational aspects, such as hydraulics (e.g., dispersion and gas transfer coefficients, wind fetch, silt suspension), cannot be readily extrapolated from smaller-scale systems and will require large ponds, even if not full size (e.g., 4 hectares). The closest so far are the four 1.25-ha ponds in New Zealand, by NIWA. Still, much of the research can be carried out with ponds of relatively small scale, in the order of even 100 m² in most cases, with verification at larger scale, about 1,000 to 10,000 m². If long-term, high productivity (biomass and oil), stable cultures with low-cost harvesting can be achieved with 100-m² ponds and confirmed with 1,000-m² ponds, then a case for moving to a full-scale pilot plant can be made. In the meantime, some work on larger ponds can be initiated to address hydraulic and mass transfer issues. The minimum period that such a research program should be planned for is five years, one year to get started, three years for experimental operations, and an additional year for any delays, follow-ups and planning for the next stage. Of course that pre-supposes that other aspects of such research can be carried out in parallel, as noted next.

The above call for pond research does not address either the front- or back-end of the process: the algae strains that would be mass cultured and the processing, including oil extraction and conversion of the harvested biomass, as well as handling of any residues. Algae biomass production is agriculture, or aquaculture, and as such the central issue is the organism being cultivated. This lack of suitable organisms is perhaps the greatest problem in this field at present: it is not clear how superior strains of algae are to be developed, starting with collection from natural habitats, isolation, selection, maintenance, and genetic improvement, or even what desirable attributes they should have. The present analysis, which focuses on oil production, suggests that high productivity, high oil content algae should be selected. But, it could be argued, that it would be better to first select for algae strains that can be mass cultured – strains that are resistant to invasions by weed algae or by grazers, and are easily harvested –

and then to improve on these to increase their productivity and oil content. Still, it is unclear at present what characteristics suitable algae would need for stable cultivation and easy harvesting, or how to select for these characteristics. Or, alternatively, how to genetically engineer these attributes into algae strains? These questions and many others must be the focus of future research, with many different approaches both possible and necessary. However, in any event, the selection and improvement of algae strains must be guided by results for the outdoor cultivation systems, rather than proceeding only from laboratory development.

Issues of less priority relate to the processing of the biomass: harvesting, cell breakage if needed, oil separation, and fate of the residual biomass (e.g., digestion and recycling or drying for animal feeds). These topics are secondary because they may depend on both the algae strain being cultivated and cultivation technologies. In addition, for reasonable scale-up of processes, large amounts of biomass are likely to be required that would not be produced in the first few years of such an R&D effort. Also, it can be anticipated that if low-cost algae biomass can indeed be produced, the technologies for converting the biomass to biofuels would become available. Of course, such research, at least for the initial stages, should also be integrated into any pond-based R&D plan.

Both the time to accomplish these tasks and the scale that algae biofuel production could achieve, are the main question asked by funders of such research. Both are unknown, and there is not much point in speculating unduly. It is clear from this report that algae oil production will be neither quick nor plentiful – ten years is a reasonable projection for the R&D to allow a conclusion about the ability to achieve relatively low-cost algae biomass and oil production, at least for specific locations. Indeed, this is a short time frame, only possible because of the fast growth rates of algae. Rapid growth is one of the few fundamental advantages of microalgae compared to other sources of biofuels, as it suggests the ability to rapidly progress in the cultivation research (a week of algae cultivation is equivalent to over a whole year of growing a higher plant crop). This will accelerate both the research and also the ability to implement any results. One of the major, fundamental disadvantages of microalgae is their requirement for CO₂, which, as discussed in Section 4, will greatly constrain their potential for making as large a contribution to future renewable oil supplies. However, even a more modest contribution than projected by many advocates, would justify a significant R&D effort. The present report provides a further basis to justify such efforts and a guide to the next steps.

WORKS CITED

- AMSA (2002). *The 2002 Financial Survey: A National Survey of Municipal Wastewater Management Financing and Trends*, Association of Metropolitan Sewerage Agencies.
- Ben Amotz, A., (2009). Algae Biomass Summit III, Algal Biomass Organization, October 6-9, San Diego, California.
- Benemann, J.R., (1990). "The Future of Microalgae Biotechnology." In: *Algal Biotechnology* (R.C. Cresswell, T.A.V. Rees, and N. Shah, eds.), Longman, London, pp. 317–337.
- Benemann, J.R. (2000). "Hydrogen production by microalgae," *Journal of Applied Phycology*, 12 pp. 291-300.
- Benemann, J.R., (2003). "Biofixation of CO₂ and greenhouse gas abatement with microalgae: technology roadmap." Final Report submitted to U.S. Department of Energy, National Energy Technology Laboratory.
- Benemann, J.R, and D. Tillett (1987). *Effects of Fluctuating Environments on the Selection of High Yielding Microalgae*. Final Report to the Solar Energy Research Institute, February 27, 1987, Subcontract XK-4-04136-06, Solar Energy Research Institute, Golden, Colorado.
- Benemann, J.R. and W.J. Oswald (1996). *Systems and economic analysis of microalgae ponds for conversion of CO₂ to biomass*. Final report, U.S. Department of Energy. <http://www.osti.gov/bridge-servlets-purl-493389-FXQyZ2-webviewable-493389.pdf>
- Benemann, J.R., P. Pursoff, and W.J. Oswald (1978). *Engineering Design and Cost Analysis of a Large-Scale Microalgae Biomass System*, Final Report to the U.S. Energy Department, NTIS #H CP/T1605-01 UC-61, pp. 91.
- Benemann, J.R., B.L. Koopman, D. Baker, R.P. Goebel, and W.J. Oswald (1977). *Design of the Algal Pond Subsystem of the Photosynthesis Energy Factory*. Final Report to the U.S. Energy Research and Development Administration, NTIS #HCPT3548-01, pp. 98.
- Benemann, J.R., J.C. Weissman, and D.C. Augenstein (1982b). *Microalgae as a source of liquid fuels*. Appendix to the Final technical report USDOE–OER.
- Benemann, J.R., R.P. Goebel, J.C. Weissman, D.C. Augenstein (1982a). *Microalgae as a source of liquid fuels*. Final technical report USDOE–OER. http://www.osti.gov/bridge-product.biblio.jsp?query_id=0&page=0&osti_id=6374113

Benemann, J.R., B. Koopman, J. Weissman, D. Eisenberg, and R. Goebel (1980). "Development of microalgae harvesting and high-rate pond technologies in California." In: *Algae Biomass*, pp. 457-499.

Benemann, J.R., J.C. Van Olst, M.J. Massingill, J.C. Weissman and D.E. Brune (2003). "The controlled eutrophication process: using microalgae for CO₂ utilization and agricultural fertilizer recycling."

Boyce, M.P. (2006). *Gas Turbine Engineering Handbook*, 3rd Edition, Gulf Professional Publishing.

Brooijmans, R.J.W. and R.J. Siezen (2010). "Genomics of microalgae, fuel for the future?," *Microbial Biotechnology*, 3(5), pp. 514–522.

Brune, D.E., T.J. Lundquist, J.R. Benemann (2009). "Microalgal biomass for greenhouse gas reductions: potential for replacement of fossil-fuels and animal feeds." *Journal of Environmental Engineering*, American Society of Civil Engineers, Vol. 135, Issue 11, pp. 1136-1144. DOI: 10.1061/ASCEEE.1943-7870.0000100

Bureau of Reclamation (2004). "Salton Sea Salinity Control Research Project," Bureau of Reclamation Technical Service Center, Denver, Colorado.

Burlew, J.S. (1953). *Algal culture from laboratory to pilot plant*. Carnegie Institute of Washington, Washington, D.C., Publication 600, pp. 357.

CIMIS (2010). Climate data, Department of Water Resources, Office of Water Use Efficiency, California Irrigation Management Information System. Data retrieved February 2010. www.cimis.water.ca.gov-cimis-welcome.jsp

Cooney, M.J., G. Young, R. Pate (2010). "Bio-oil from photosynthetic microalgae: Case study." *Bioresource Technology* (in press).

Craggs, R., and J. Park (2009). Algae Biomass Summit III, Algae Biomass Organization, October 6-9, San Diego, California.

Darzins, A., P. Pienkos, and L. Edye (2010). *Current Status and Potential for Algal Biofuels Production*, Report prepared for the International Energy Agency, Bioenergy Task 39, Report T39-T2. 6 August 2010, National Renewable Energy Laboratory and BioIndustry Partners, Golden, Colorado, pp. 131. www.task39.org

Dominguez-Faus, R., S.E. Powers, J.G. Burken, and P.J. Alvarez (2009). "The Water Footprint of Biofuels: A Drink or Drive Issue," *Environ. Sci. Technol.* 43 (9), pp. 3005–3010.

Eroglu, E. and A. Melis (2010). "Extracellular terpenoid hydrocarbon extraction and quantitation from the green microalgae *Botryococcus braunii* va. Showa," *Bioresource Technology*, 101, pp. 2359-2366.

Falkowski, P.G. and J.A. Raven (2007). *Aquatic Photosynthesis*. 2nd ed., Princeton University Press, Princeton, New Jersey.

Farnsworth, R.K. and E.S. Thompson (1982). "Mean monthly, seasonal, and annual pan evaporation for the United States," NOAA Techn. Rept. NWS 34, pp. 3.

Feinberg, D., and M. Karpuk (1990). *CO₂ Sources for Microalgae-Based Liquid Fuel Production*, SERI/TP-232-3820, Solar Energy Research Institute.

Feth, J. H. (1965) "Preliminary map of the conterminous United States showing depth to and quality of shallowest ground water containing more than 1,000 part per million dissolved solids," U.S. Geological Survey Hydrologic Investigation Atlas HA-199. Reston, Virginia.

Gershwin, M.E., and A. Belay (2007) *Spirulina in Human Nutrition and Health*, CRC Press, Boca Raton, Florida.

Golucke, C.G. and W.J. Oswald (1959). "Biological conversion of light energy to the chemical energy of methane," *Applied Microbiology*, 7:4, pp. 219-227.

Golueke, C.G., Oswald, W.J., and Gotaas, H.B., (1957) "Anaerobic Digestion of Algae," *Applied Microbiology*, Vol. 5. pp 47-55.

Gouveia, L. and A.C. Oliveira (2009). "Microalgae as a raw material for biofuels production," *J. Ind. Microbiol. Biotechnol.*, 36, pp. 269–274. DOI 10.1007/s10295-008-0495-6

Green, F.B., L.S. Bernstone, T.J. Lundquist, and W.J. Oswald (1996). "Advanced Integrated Wastewater Pond Facilities for Nitrogen Removal," *Wat. Sci. Tech.* 33(7), pp. 207-217.

Grobbelaar, J.U. (2010). "Microalgal biomass production: challenges and realities," *Photosynth. Res.* DOI 10.1007/s11120-010-9573-5

Harder, R., and K. von Witsch (1942). "Uber Massenkultur von Diatomeen," *Ber. Deut. Bot. Ges.* 60, pp. 146-152.

Harmelen, T., and H. Oonk (2006). "Microalgae biofixation processes. Application and potential contributions to greenhouse gas mitigation options," *TNO Built Environment and Geosciences*.

Hauck, J. T., S.J. Scierka, and M.B. Perry (1996). "Effects of simulated flue gas on growth of microalgae." *Proceedings of 212th ACS National Meeting*, 25-30 August, Orlando, Florida, 41(4), pp. 1391-1396.

Hill, J., E. Nelson, D. Tilman, S. Polasky, and D. Tiffany (2006). "Environmental, economic, and energetic costs and benefits of biodiesel and ethanol biofuels," *Proc. Natl. Acad. Sci. U.S.A.* 103 (30), pp. 11206–11210.

Hudson, N.W. (1993) "Field measurement of soil erosion and runoff," Food and Agricultural Organization of the United Nations, *Soils Bulletin*.

Huesemann, M.H., T.S. Hausmann, R. Bartha, M. Aksoy, J.C. Weissman, and J.R. Benemann (2009). "Biomass Productivities in Wild Type and Pigment Mutant of *Cyclotella* sp. (Diatom)," *App. Biochem. Biotech.*, 157, pp. 507-526.

Huesemann, M., G. Roesjadi, J. Benemann, F.B. Metting (2010). "Biofuels from Microalgae and Seaweeds," *Biomass to Biofuels: Strategies for Global Industries*, John Wiley and Sons, Ltd., West Sussex, U.K.

Huntley, M.E. and D. Redalje (2007). "CO₂ mitigation and renewable oil from photosynthetic microbes: a new appraisal," *Mitigation and Adaptation Strategies for Global Change* 12: 573–608.

IWDP, Industrial Waste Diversion Program (1991). "Ammonia Recovery Feasibility Study, Final Report #13" *Waste Management Branch Ontario Ministry of the Environment*, Queen's Printer for Ontario.

Kawamura, S., and W. McGivney (2008). *Cost Estimating manual for water treatment facilities*, John Wiley & Sons Inc. Hoboken, New Jersey.

Koikai J. S., (2008) "Utilizing GIS-Based Suitability Modeling to Assess the Physical Potential of Bioethanol Processing Plants in Western Kenya."

Kok, B. (1973). "Photosynthesis." In: *Proceedings of the Workshop on Bio Solar Hydrogen Conversion*, (Gibbs, M., A. Hollaender, B. Kok, L. O. Krampitz, and A. San Pietro, eds.), National Science Foundation, September 5-6, 1973, Bethesda, Maryland, pp. 22-30.

Kruse O., J. Rupprecht, J. Mussnug, G.C. Dismukes, and B. Hankamer (2005). "Photosynthesis: a blueprint for solar energy capture and bio-hydrogen production technologies." *Photochemical and Photobiological Science*, Vol. 4, pp. 957-969.

Kumar, A., S. Ergas, X. Yuan, A. Sahu, Q. Zhang, J. Dewulf, F.X. Malcata, and H. van Langenhove (2010). "Enhanced CO₂ fixation and biofuel production via microalgae: recent developments and future directions," *Trends in Biotechnology*, 28, pp. 371–380.

Lardon, L., B. Sialve, J.-P. Steyer, and O. Bernard (2009). "Life-Cycle Assessment of Biodiesel Production from Microalgae." *Environ. Sci. Technol.* 43 (17), 6475–6481.

Liu, X., D. Brune, W. Vermaas, and R. Curtiss (2010). "Production and Secretion of fatty acids in genetically engineered cyanobacteria." *Proceedings of the National Academy of Sciences of the United States of America*.

Lundquist, T.J., F.B. Green, N.W.T. Quinn, S.E. Borglin, C. Hsieh, R.Y. Huang, and W.J. Oswald (2004). *Development of Drainage Treatment for the San Joaquin River Water Quality Improvement Project*, Final Report, California Department of Water Resources, Fresno, California, pp. 101.

Luthria, D. L. (2004). "Oil Extraction and Analysis: Critical Issues and Comparative Studies," *The American Oil Chemists Society*.

Mata, T.M., A.A. Martins, and N.S. Caetano (2010). "Microalgae for biodiesel production and other applications: A review," *Renewable and Sustainable Energy Reviews*, 14, pp. 217–232.

Maxwell E. L., A. G. Folger, and S. E. Hogg, (1985) "Resource evaluation and site selection for microalgae production systems," Solar Energy Research Institute.

Metcalf and Eddy (2003). *Wastewater Engineering: Treatment and Reuse*. 4th Ed., Tchobanoglous, G., Burton, F.L., Stensel, H.D., McGraw Hill, ISBN-13: 978-0-07-041878-3.

Moheimani N. R. and M. A. Borowitzka, (2006) "The long-term culture of the coccolithophore *Pleurochrysis carterae* (Haptophyta) in outdoor raceway ponds." *Journal of Applied Phycology*, vol. 18, pp. 703-712.

Nakajima, Y., and R. Ueda, (1997) "Improvement of photosynthesis in dense microalgal suspension by reduction of light harvesting pigments." *Journal of Applied Phycology*. Vol 9. pp. 503-510.

Nakajima, Y., and R. Ueda (1999) "Improvement of microalgal photosynthetic productivity by reducing the content of light harvesting pigment." *Journal of Applied Phycology*. Vol 11. pp. 195-201.

Nakajima, Y., and R. Ueda (2000). "The effect of reducing light-harvesting pigment on marine microalgal productivity." *Journal of Applied Phycology*. Vol 12. pp. 285-290.

NC Division of Coastal Management, NC Center for Geographic Information and Analysis. Land Suitability Analysis User Guide, December 2005, <http://www.docstoc.com/docs/3442212/Land-Suitability-Analysis-User-Guide-NC-DIVISION-OF-COASTAL-MANAGEMENT>.

Neenan, B., Feinberg, D., Hill, A., McIntosh, R., and Terry, K., (1986). *Fuels from Microalgae: Technology status, potential and research requirements*, SERI/SP-231-2550, Solar Energy Research Institute, Golden, Colorado.

Neidhardt, J.; Benemann, J.R.; Zhang, L.; and Melis, A. (1998) "Maximizing photosynthetic productivity and light utilization in microalgae by minimizing the light-harvesting chlorophyll antenna size of the photosystems." *Photosynthesis Research*, 56, pp. 175-184.

NOAA, Surface Radiation Network (SURFRAD); National Oceanic and Atmospheric Administration: Boulder, CO, 2009.

NREL, *National Solar Radiation Database (1961-1990)*; National Renewable Energy Laboratory: Golden, CO, 1994.

Ogershok, D., and Pray, R., (2009) National Construction Estimator. *Craftsman Book Company*.

Oswald, W.J. and Golueke, C. (1960) "Biological transformation of solar energy." *Adv. Appl. Microbiol.* (2), 223–262.

Oswald, with H.B. Gotaas, H.F. Ludwig and V. Lynch. , (January 1953). "Algae Symbiosis in Oxidation Ponds. II. Growth Characteristics of *Chlorella pyrenoidosa* Cultured in Sewage," Reprinted in *Sewage and Industrial Wastes* 25:1

Oswald, W.J., A. Meron and M.D. Zabat (1970). "Designing Waste Ponds to Meet Water Quality Criteria," Proceedings of the Second International Symposium for Waste Treatment Lagoons, June 23-25, 1970, Kansas City, Missouri, pp. 10.

Pate, R. (2008) "Algal Biofuels Techno-Economic Modeling and Assessment," Sanida National Laboratories, December.

Pedroni, P.M., Lamenti, G., Prosperi, G., Ritorto, L., Scolla, G., and Cauano, F., (2004) "Enitechnologie R&D project on microalgae biofixation of CO₂: Outdoor comparative tests of biomass productivity using flue gas CO₂ from a NGCC power plant." Paper presented at the *Seventh International Conference on Greenhouse Gas Control Technologies*. Vancouver, Canada.

Pimentel, D. (2003), "Ethanol fuels: energy balance, economics, and environmental impacts are negative." *Natural Resources Research*, Vol. 12, pp 127-134.

Poullikkas, A. (2005). "An overview of current and future sustainable gas turbine technologies" *Renewable and Sustainable Energy Reviews*. Vol. 9, pp 409-443.

Reed Construction data (2009). "Site Work and Landscape," CostWorks (CD-ROM), RS Means Company.

Raymond (1981). "Mass Algal Culture Systems," U.S. Patent 4,253,271, March 3, 1981.

Rice, P. and W. Hamm (1988). "Density of soybean oil-solvent mixtures," *Journal of American Oil Chemists Society*, Vol. 65, No. 7, pp. 1177-1178.

Rodolfi, L., Zittelli, G., Bassi, N., Padovani, G., Biondi, N., Bonini, G., and Tredici, M. (2009). "Microalgae for oil: Strain selection, induction of lipid synthesis and outdoor mass cultivation in a low-cost photobioreactor." *Biotechnology and Bioengineering*, 102(1), pp. 100-112.

Runge, C. F. and Senauer, B. (2007). "How Biofuels Could Starve the Poor," *Foreign Affairs*, May/June.

Schenk, P.M., Thomas-Hall, S.K., Stephans, E., Marx, U.C., Mussgnug, J.H., Posten, C., Kruse, O., and Hankamer, B. (2008). "Second Generation Biofuels: High-Efficiency Microalgae for Biodiesel Production," *Bioenergy Research*, Vol 1, (1) pp. 20-43.

Sheehan, J., Dunahay, T., Benemann, J., Roessler, P., and Weissman, J. (1998). *Look Back at the U.S. Department of Energy's Aquatic Species Program: Biodiesel from Algae; Close-Out Report*, NREL Report No. TP-580-24190, pp. 325. Available on: <http://www.nrel.gov/docs-legosti-fy98-24190.pdf>

Shiffrin, N.S., and Chisholm, S.W. (1981) "Phytoplankton lipids: interspecific differences and effects of nitrate, silicate and light-dark cycle," *Journal of Phycology*, Vol. 17, pp. 374-384.

Sialve, B., N. Bernet, and O. Bernard (2009). "Anaerobic digestion of microalgae as a necessary step to make microalgal biodiesel sustainable," *Biotechnology Advances*, 27, pp. 409-416.

Singh, J., S. Gu (2010). "Commercialization potential of microalgae for biofuels production," *Renewable and Sustainable Energy Reviews*.

Singh, J. Panesar, B.S., Sharma, S.K. (2010). "A mathematical model for transporting the biomass to biomass based power plant," *Biomass and Bioenergy*, 34(4), pp. 483-488.

Spierling, R.E., L.C. Albinger, and T.J. Lundquist (2009). "Technical and Economic Feasibility of Applying Standard Wastewater Treatment Technology to Dairy Manure Management," Final report for the USEPA, Region 9, Award No. EP089000064.

Tredici, M. (2010). "Photobiology of microalgae mass cultures: understanding the tools for the next green revolution," *Biofuels*, 1(1), pp. 143-162.

UC Berkeley Geospatial Information Facility, "Projection: What you need to know for GIS," http://gif.berkeley.edu/documents/Projections_Datums.pdf.

US Bureau of Reclamation (2004). Data obtained from US Department of the Interior, Bureau of Reclamation, Lower Colorado Region, Boulder City, Nevada and the Salton Sea Authority La Quinta, California "Salton Sea Salinity Control Research Project" 2004 Bureau of Reclamation Technical Service Center, Denver Colorado.

USDA (2009). "Web Soil Survey," United States Department of Agriculture, National Resource Conservation Service, data retrieved 2009. <http://websoilsurvey.nrcs.usda.gov>

US DOE (2009). *National Algal Biofuels Technology Roadmap*, June 2009 draft, Office of Energy Efficiency and Renewable Energy, pp. 214.

US EPA (1991) Guidance for Water Quality-Based Decisions: The TMDL Process United States Environmental Protection Agency, Office of Water, Washington, DC 20460, EPA 440/4-91-001, April, 1991. http://water.epa.gov/lawsregs/lawguidance/cwa/tmdl/decisions_index.cfm

Vigon B. W., M. F. Arthur, L. G. Taft, C. K. Wagner, E. S. Lipinsky, J. H. Litchfield, C. D. McCandlish, and R. Clark (1982). "Resource assessment for microalgal/emergent aquatic biomass in the arid southwest," *Battelle Columbus Laboratory Report*.

Vonshak, A., Torzillo, G., Masojidek, J., and Boussiba, S. (2001). "Sub optimal morning temperature induces photo inhibition in dense outdoor cultures of the alga *Monodus sbterraneus* Eustigmatophyta *Plan*," *Cell and Environment*, Vol. 24, pp. 1113-1118.

Wang, B., Y. Li, N. Wu, and C.Q. Lan (2008). "CO₂ bio-mitigation using microalgae," *Appl. Microbiol. Biotechnol.*, 79, pp. 707–718.

Weissman, J.C. and J.R. Benemann (1981). "Polysaccharide Production by Microalgae", Phase I Final Report to the National Science Foundation under Grant No. PFR 79-17646, pp. 50.

Weissman, J.C. and Goebel, R.P. (1987). *Design and analysis of microalgal open pond systems for the purpose of producing fuels*, subcontract report, USDOE.

Weissman, J. C. and Tillett, D.M. (1989) "Design and Operation of an Outdoor Microalgae test Facility" *Solar Energy Research Institute Aquatic Species Program Annual Report*: Golden, CO, 1989.

Weissman, J. C. and D.M. Tillett (1990). *Design and Operation of an Outdoor Microalgae Test Facility: Large-Scale System Results*, National Renewable Energy Laboratory, Golden, Colorado.

Weissman, J., R. Goebel, and J. Benemann (1988). "Photobioreactor Design: Mixing, Carbon Utilization, and Oxygen Accumulation," *Biotechnology and Bioengineering*, 31, pp. 336-344.

Weyer, K., Bush, D., Darzins, A., and Willson, B. (2010). "Theoretical Maximum Algal Oil Production," *Bioenergy Resource*, Vol. 3, pp. 204-313.

Wigmosta, M.S., A.M. Coleman, M. H. Huesemann, and R. Skaggs, (2009) "A National Resource Availability Assessment for Microalgae Biofuel Production," Progress Report to the Department of Energy, PNNL -18928, October 2009.

Woertz, I.C., L. Fulton, and T.J. Lundquist (2009). "Nutrient removal & greenhouse gas abatement with CO₂-supplemented algal high rate ponds." Paper written for the WEFTEC annual conference, Water Environment Federation, October 12-14, 2009, Orlando, Florida, pp. 13.

Yen, H-W and D.E. Brune (2007). "Anaerobic co-digestion of algal sludge and waste paper to produce methane," *Bioresource Technology*, 98, pp. 130-134.

APPENDIX 1: PANEL MEETINGS

**Energy Biosciences Institute
Algae Biofuels Assessment Workshops
Berkeley, California
January 15-16, 2009**

EXECUTIVE SUMMARY

A technical discussion was held during a two-day workshop on algae biofuel production on January 15 and 16, 2009. The panelists represented some of the acknowledged leaders of algae fuel biotechnology in the United States. Their input and insights have been incorporated into the main text of this report.

BACKGROUND

There is considerable interest in biofuel production from algae or cyanobacteria following the mid-year spike in crude oil prices in 2008. There is also a need for alternative fuels for transportation needs because of the shrinking reserves of light, sweet crude oil. The oil that remains to be extracted for transportation fuels will be increasingly costly to produce. One of the benefits of a living biomass stock for biofuel production is the consistency that can be achieved, making the final production stages more streamlined and therefore less costly. Algae are a particularly attractive biofuel source for a variety of reasons, not least of which is that there would be little or no competition with world food supplies.

There are several important factors to consider in any evaluation of the potential of biofuel production from algae. The US DOE Aquatic Species Program laid the groundwork for current research into algae biofuels. During the project, various photosynthetic storage compounds (lipids, sugars) from several diatoms, green algae, cyanobacteria, and other algae were cataloged. The nuclear and chloroplast genomes of some organisms were sequenced, at least partially, yielding a strong platform from which to pursue future studies into possible productivity increases. This knowledge combined with that gained by private companies that have been growing and harvesting cyanobacteria and algae for decades points to some potentially fruitful areas for research in the coming years.

PURPOSE OF THE WORKSHOPS

A report entitled “A Realistic Technology and Engineering Assessment of Algae Biofuel Production” is being prepared to assess the technology, economics, resource potential, and

environmental impacts/benefits of microalgae biofuels, and to help guide possible future algae biofuel research, by EBI and others in this field. Inputs from two workshop panels are being sought to identify research needs, priorities and strategies in both the biological and engineering aspects of this field. The project team is gathering and developing information on algae production and biomass processing technologies, and the initial results of this study will be presented and discussed during the workshop. Engineering designs for algae-based wastewater treatment and biofuel feedstock production facilities (100- and 400- hectare) are being prepared, and a review of the biological basis of algae biomass production is in progress. These initial results will be used as a basis for discussions during these two one-day workshops on the biology and engineering of microalgae biofuels production.

Each workshop involved eight to nine invited experts as discussion participants as well as the project team. Some panel participants in one workshop acted as observers on the other, and a few additional observers from EBI and BP attended. The objective of these Workshops was to help develop a focused “Assessment of Technology Research Needs” that would assist EBI and others interested in this field to focus on the realistic potential and plausible economics of microalgae biofuels, the near- and medium-term research needs, and the possible resource potential for such technologies.

AGENDA

The agenda used for the workshops is reproduced below. Each topic had one or two assigned discussion leader(s) who introduced the topic (e.g. current status, what the issues are as she/he saw them), followed by brief statements from the participants on the topic, and then general discussions by all participants. Observers were encouraged to ask questions and provide inputs during the general discussion period. The conclusion of each day was devoted to summation and recommendations for action items. Notes of the discussions were taken but no comments or statements quoted will be attributed to any participant in the final report (unless specifically requested to do so). PowerPoint slides were presented by the participants, as desired, and the entire event was recorded to assist in compiling a complete and accurate report of the event.

Algae Biofuels Assessment Project

Sponsored by the Energy Biosciences Institute (EBI)
Calvin Lab, U.C. Berkeley, California

Biology and Biotechnology Issues Workshop: Thursday, January 15, 2009

Engineering and Resources Issues Workshop: Friday, January 16, 2009

PIs: Tryg Lundquist, Cal Poly (tlundqui@calpoly.edu), Nigel Quinn, LBNL (nwquinn@lbl.gov); Robert Dibble, UCB, and John Benemann, Benemann Associates

Agenda for Algae Biofuels Assessment Workshops

Biological Issues Panel, Thursday, January 15, 2009 (Discussion Leaders)

8:30–9:00 AM	Assembly. Coffee/continental breakfast provided.
9:00–9:50	Introductions by participants. Status of the EBI project (Quinn, Lundquist)
9:50–10:30	Algae type/species, isolation, screening, selection (Benemann)
10:30–11:00	Break
11:00–11:40	Algae mass cultivation, predator control (Belay)
11:40–12:20PM	Photosynthesis and productivity, plausible goals (Vermaas)
12:20–1:20	Lunch (in meeting room)
1:20 –2:00	Algae oil, carbohydrates, higher value products (Cooksey)
2:00–3:10	Algae genetics, genomics - green and cyano (Grossman, Golden)
3:10–3:40	Break
3:40–4:20	Discussion of regulatory issues (GMO releases) general topics (Heifetz)
4:20–5:00	Summaries, general discussion, action items, next steps, conclusions.
6:00–8:30	Reception and dinner for all participants (<u>both panels</u>). Faculty Club.

Engineering and Resources Issues Panel, Friday, January 16, 2009

8:30–9:00 AM	Assembly. Coffee/continental breakfast provided.
9:00 –9:45	Introductions by participants. Status of EBI project (Quinn, Lundquist).
9:45–10:30	Open ponds and photobioreactors (Goebel and Benemann)
10:30–11:00	Break
11:00–11:45	Algae harvesting and biofuel processing (oil extraction) (Brune, Ensani)
11:45–12:30PM	Resources: CO ₂ , nutrients, water, land (Quinn and Wu)
12:30 –1:30	Lunch (in meeting room)
1:30–2:15	Wastewater treatment (Eisenberg, Gerhardt)
2:15–3:00	Cost analysis of algae biofuels (Lundquist, Woertz)
3:00 –3:30	Break
3:30–4:15	Sustainability, LCA. (Sheehan)
4:15–5:00	Summaries, general discussion, action items, next steps, conclusions

BACKGROUND INFORMATION:

Several documents can be consulted for background information: A recent introduction to the topic by Benemann, Sheehan et al. 1998, on the Aquatic Species Program (<http://www.nrel.gov/docs/legosti/fy98/24190.pdf>) and a Technology Roadmap (Benemann 2003) <http://www.co2captureandstorage.info/networks/networks.htm>. In addition, a collection of papers and presentations are on two websites for recent meetings; DOE Algal Biofuels Technology Roadmap Workshop (December 2008) <http://www.orau.gov/algae2008/resources.htm> and AROSR-NREL, Algal Oil for Jet Fuel Production, http://www.nrel.gov/biomass/algal_oil_workshop.html February, 2008.

Participants

The workshops were organized by the PIs with the assistance of EBI and the Department of Mechanical Engineering. For each topic, scientists and engineers with specific expertise were invited to participate in the workshops. Those who accepted were asked to lead the discussion of their area of expertise. In addition, observers from EBI and BP attended and also provided comments and questions. Altogether, 29 individuals attended the two days of workshops. Their names and affiliations are provided below.

Organizers	Organization	
Tryg Lundquist	Cal Poly Sate Univ.	
John Benemann	Consultant	
Nigel Quinn	LBNL	
Robert Dibble	UCB	
Ian Woertz	Cal Poly Sate Univ.	
Yvette Piceno*	LBNL	
* Substituting for Gary Andersen		

Biology and Biotechnology Issues, Thursday, January 15th		
Panelists	Organization	
Amha Belay	Earthrise	
John Benemann	Consultant	
Chris Cannizarro	US State Department	
Keith Cooksey	University of Montana	
Susan Golden	UC San Diego	
Arthur Grossman	Carnegie Institution, Stanford U.	
Peter Heifetz	Consultant	
Christer Jansson	LBNL	
Wim Vermaas	Arizona State University	

Observers, Day 1		
Mitchell Altschuler	EBI	
Binita Bhattacharjee	BP	
Martin Carrera	BP	
Jose Escovar-Kousen	BP	
Amit Gokhale	BP	
John Sheehan	Consultant	

Engineering and Resources Issues, Friday, January 16th		
Panelists	Organization	
John Benemann	Consultant	
David Brune	Clemson University	
Don Eisenberg	EOA, Inc.	
Elahe Enssani	San Francisco State University	
Dan Frost	Carollo Engineers	
Matt Gerhardt	Brown and Caldwell	
Ray Goebel	EOA, Inc.	
Tryg Lundquist	Cal Poly Sate Univ.	
Jay Mackie	CH2MHill	
Nigel Quinn	LBNL	
John Sheehan	Consultant	
Ian Woertz	Cal Poly Sate Univ.	
Ben Wu	LiveFuels, Inc.	

Observers, Day 2		
Mitchell Altschuler	EBI	
Amha Belay	Earthrise	
Binita Bhattacharjee	BP	
Martin Carrera	BP	
Keith Cooksey	University of Montana	
Jose Escovar-Kousen	BP	
Amit Gokhale	BP	
Susan Golden	UC San Diego	
Martin Gordon	Carbon Capture Corporation	

APPENDIX 2: SOLVENT EXTRACTION PROCESS DESCRIPTION

SOLVENT EXTRACTION OF ALGAE PROCESS DESCRIPTION

Provided courtesy of
Crown Iron Works Company
2500 West County Road C
Roseville, MN 55113

EXTRACTION SYSTEM

Properly prepared Algae are fed through a **Plug Screw Conveyor**, or **Rotary Valve** to the **Crown Extractor** and enter through a flake inlet hopper on top of the extractor.

The **Crown Model IV Extractor** is a continuous counter current Immersion Type Extractor that employs a shallow bed approach to extraction. The Model IV Immersion Extractor is designed for granular materials that have a higher density than the solvent, and will therefore sink in the solvent. The extractor maintains a solvent bath in which the solids remain completely submerged in the solvent until the final stage where drainage and drainage occurs before solids discharge.

Fresh solvent enters the Model IV Extractor at the last stage just as the solids are conveyed out of the solvent bath by the en masse conveyors. This ensures that the solids are washed with pure solvent prior to discharge thus maximizing the effectiveness of the solvent and overall extraction process. Miscella (combination of solvent and oil) flows counter current to the solids flow and becomes more concentrated as it comes in contact with the higher oil content solids. The counter current continuous approach ensures maximum extraction of oil with minimal solvent use, thereby minimizing size and cost of downstream operating equipment. The rich or full miscella discharges from the extractor to a **Miscella Tank** before being pumped to the **First Stage Evaporator**.

The Model IV has several inclined trays installed in series that uses a series of en masse conveyors (one per tray) to gently move the material from tray to tray thereby minimizing wear from abrasion. Discharge from each tray encourages full turnover of the bed as the material falls from tray to tray. The advantage of the shallow bed is that the material is subjected to less compression and is therefore less likely to agglomerate into large lumps that will inhibit the

extraction process. After the last wash with fresh solvent, the solids are conveyed to the solids discharge and exit smoothly and undisturbed from the extractor by gravity.

After exiting the extractor, the wet flakes are conveyed by means of a vapor tight **Spent Flake Conveyor** to the **Desolventizer Toaster**. The solvent laden flakes enter the top of the Desolventizer toaster and land on the steam heated predesolventizing tray(s) where they are evenly distributed by a sweep arm. The meal flows from one tray to the next through tray openings. These top trays are pre-desolventizing trays and "flash" the vapor hexane from the white flakes. The main (middle) trays are designed for indirect steam heating and have hollow stay bolts for venting vapors from one tray to the next. These vapors travel counter current to the direction of meal travel. Meal levels in these trays are controlled by chutes, which convey the material down through the unit. The bottom tray contains a specially designed variable speed rotary valve to maintain a level in the unit. This bottom tray is perforated for direct "sparge" steam injection, which strips the final solvent from the meal and vents up through all the hollow staybolt trays above.

The quantity of trays and their positions are carefully designed to allow maximum contact between vapors and meal. True countercurrent desolventization is achieved, resulting in a uniquely low solvent content in the desolventized meal, significantly reducing solvent losses. The combination of steam heated trays and counter-current steam stripping raises the meal temperatures quickly. Also, temperatures in lower trays are more stable which provides for a greater degree of safety.

From the desolventizer toaster the meal passes through the rotary valve and directly into the drying section of the dryer cooler. The drying and cooling is accomplished by blowing heated air in the drying section (dryer trays) and using ambient air to cool the meal in the cooling section (cooling tray).

Air leaves the DC via Ducting and DC Cyclones, which have rotary airlocks at the bottom. All ducting supplied by Client. An optional Dust Filter can be supplied in addition to, or in place of the Cyclones.

The desolventized, dried and cooled meal leaves the DTDC via the DTDC Discharge Conveyor. The finished meal is conveyed to meal processing and storage by the **Finished Meal Conveyor**.

From the Desolventizer Toaster (DT), the hot hexane vapors are sent to the **First Stage Evaporator** where they are used to heat the miscella which is pumped over from the extractor. The full miscella enters the bottom of the first stage evaporator and is pumped upward through stainless steel tubes. The hot hexane vapors are pulled downward around the stainless steel tubes as the vessel operates under a slight vacuum. A large diameter swirling type vapor dome mounts on top of the vessel separating vapors from the miscella.

The vapors from the first stage evaporator go to the **Evaporator Condenser**. The concentrated miscella flows to the **Miscella/Hot Oil Interchanger** where it is heated by hot oil from the oil stripper and is subsequently pumped up through steam heated steel tubes in the **Second Stage Evaporator** where hexane vapors are flashed off. The hot vapors from the dome on top of the second stage evaporator also go to the Evaporator Condenser while the oil flows to the **Oil Stripper**. Excess DT vapors from the first stage evaporator shell go to the **Desolventizer Condenser**. In most plants, vapors first pass through a **Vapor Contactor** or a **Vapors/Solvent Interchanger** which removes additional heat from the vapors before they enter the DT condenser and thus improve the overall steam efficiency of the plant. The desolventizer condenser condenses the residual solvent vapors from the DT after they pass through the first stage. The resulting liquid hexane goes to the solvent work tank. The miscella leaving the first stage evaporator is about 85% oil, while the miscella leaving the second stage evaporator is approximately 98% oil.

After the second stage evaporator the miscella enters the **Oil Stripper**. This disc and donut type oil stripper "strips" the remaining solvent from the oil using sparge steam and the vapors are drawn off the vessel's dome to the **Oil Stripper Condenser**. The oil is pumped out the bottom (reservoir) and is run through the **Hot Oil/Miscella Interchanger** where it is cooled before going to storage (while heating the miscella going from the first stage evaporator to the second stage evaporator). The distillation system operates under partial vacuum for efficiency.

The Extractor is vented to an **Extractor Condenser** and then to the **Vent Condenser**. Excess, non condensed vent gasses from the DT condenser and vapors from the rest of the plant are also sent to the **Vent Condenser** where they are cooled before they enter the solvent air separator system.

The Solvent Air Separation System (a.k.a. the Mineral Oil absorption System, or MOS for short) removes solvent from vent gasses before discharging to atmosphere. Non-condensable gases enter the bottom of the **Mineral Oil Absorber** and rise through the tower packing, counter-current to the flow of cold mineral oil admitted at the top. The solvent is subsequently absorbed by the mineral oil and the desolventized gasses are drawn off through a demister at the top. The air is drawn through a fan and vented through a flame arrester well below lower explosive limits. The solvent laden mineral oil collected at the bottom of the absorption column is pumped through a heat exchanger and the **Mineral Oil Heater** to the top of the **Mineral Oil Stripper**. Here, the solvent is removed from the mineral oil by live steam evaporation as the mineral oil trickles down through the tower packing. The solvent vapors drawn off at the top of the stripping column travel back to the evaporator condenser (or in some cases the vent condenser). Solvent-free mineral oil collected at the bottom of the mineral oil stripper is recycled through the **Mineral Oil Interchanger / Cooler** and back to the

top of the absorption column where the cycle is repeated. An optional **Chiller System** can be supplied for the Mineral Oil System to further improve efficiency.

The reclaimed solvent from all condensers drains by gravity or is pumped to the **Solvent Work Tank**. This tank is designed for separating the water from the solvent. Part of the tank is also used for working storage of solvent before it goes to the extractor. Waste water from the solvent/water separator is heated with live steam to above the boiling point of solvent in the **Waste Water Reboiler** to ensure that all traces of solvent have been removed.