

NEW YORK STATE
DEPARTMENT OF TRANSPORTATION
**LAND SURVEYING
STANDARDS AND
PROCEDURES MANUAL**



NYSDOT Design Division
Design Services Bureau
Land Surveying Section
2005
REVISIONS 2009

TABLE OF REVISIONS

CHAPTER	Revisions	DATE
1.INTRODUCTION	Added US Customary Units (USC)	1/2009
2.SURVEY SAFETY	Changed MUTCD reference to Federal MUTCD and NY supplement.	1/2009
3.PUBLIC RIGHTS AND NOTIFICATION		1/3/2005
4.CREW COMPOSITION, PERSONNEL, AND EQUIPMENT	Added US Customary Equipment	1/2009
5.SPATIAL POSITIONING ACCURACY STANDARDS	Added US Customary Units of Length	1/2009
6.NYS DOT COORDINATE SYSTEMS AND DATUMS	Changed required datum adjustment to CORS96. Included warning of using older US Customary contract plans that may use a different vertical datum. Added US Customary Units of length.	1/2009
7.CONTROL NETWORK DENSIFICATION AND EXTENSION	Changed required datum adjustment to CORS96. Added NYSNet CORS to NSRS Map. Added reference to NGS CORS Site guidelines.	1/2009
8.PRIMARY PROJECT CONTROL	Updated Control Network diagrams throughout chapter. Added US Customary Units throughout chapter. Reduced the amount of receivers that need to be employed on the project while including CORS into the control network. Changed required network connections from HARN to CORS.	1/2009
9.SECONDARY PROJECT CONTROL	Added US Customary Units throughout chapter.	1/2009
10.PHOTOGRAMMETRIC CONTROL SURVEYS	Added US Customary Units throughout chapter. Included procedures for local and network RTK.	1/2009
11.TERRAIN DATA (TOPOGRAPHIC) SURVEYS	Added US Customary Units throughout chapter.	1/2009
12.RIGHT OF WAY (ROW) MAPPING SURVEYS	Added US Customary Units throughout chapter.	1/2009
13.BRIDGE AND HYDRAULIC SURVEYS	Added US Customary Units throughout chapter.	1/2009
14.RAILROAD SURVEYS	Added US Customary Units throughout chapter.	1/2009
15.CONSTRUCTION SURVEYS	Added US Customary Units throughout chapter.	1/2009
16.FIELD EDITS OF PHOTOGRAMMETRIC MAPPING	Added US Customary Units throughout chapter.	1/2009
17.APPENDIX	Added US Customary Units throughout. Updated Description of Terms	1/2009

TABLE OF CONTENTS

NEW YORK STATE.....	1-1
DEPARTMENT OF TRANSPORTATION.....	1-1
LAND SURVEYING STANDARDS AND PROCEDURES MANUAL.....	1-1
TABLE OF REVISIONS.....	1-3
TABLE OF CONTENTS	1-4
1. INTRODUCTION.....	1-11
1.1 PURPOSE.....	1-13
1.2 STANDARDS	1-14
1.3 PROCEDURES	1-14
1.4 REFERENCES.....	1-14
2. SURVEY SAFETY.....	2-15
2.1 INTRODUCTION.....	2-16
2.2 DEPARTMENT SAFETY AND HEALTH POLICY.....	2-16
2.3 TRAFFIC CONTROL.....	2-17
2.3.1 Reconnaissance Survey off of the roadway	2-17
2.3.2 Project Control Survey	2-18
2.3.3 Terrain Data Survey	2-18
2.4 SAFETY EQUIPMENT	2-18
2.5 SAFE PRACTICES	2-19
2.6 INDIVIDUAL RESPONSIBILITIES	2-19
2.7 SURVEY CREW CHIEF RESPONSIBILITIES.....	2-20
2.8 SURVEY SECTION SUPERVISOR RESPONSIBILITIES	2-20
3. PUBLIC RIGHTS AND NOTIFICATION.....	3-21
3.1 INTRODUCTION.....	3-23
3.2 COURTESY	3-23
3.3 WHAT TO DIVULGE	3-23
3.4 RIGHT OF ENTRY.....	3-23
3.5 CORPORATE PROPERTY.....	3-24
4. CREW COMPOSITION, PERSONNEL, AND EQUIPMENT.....	4-25
4.1 PERSONNEL	4-27
4.2 EQUIPMENT	4-27
5. SPATIAL POSITIONING ACCURACY STANDARDS.....	5-31
5.1 INTRODUCTION.....	5-33
5.2 STANDARDS	5-33
5.3 PROCEDURES	5-33
5.4 DATA COLLECTION METHODS.....	5-35
5.4.1 GPS Data Collection Methods.....	5-35
5.5 REFERENCES.....	5-35
6. NYS DOT COORDINATE SYSTEMS AND DATUMS.....	6-37
6.1 INTRODUCTION.....	6-38
6.2 REFERENCE SYSTEM	6-38
6.3 COORDINATE SYSTEM.....	6-38
6.4 NYSPCS ZONES	6-40
6.5 HORIZONTAL DATUM	6-40
6.6 VERTICAL DATUM	6-42
6.7 UNITS OF LENGTH	6-42
6.8 COORDINATE CONVERSIONS.....	6-42

TABLE OF CONTENTS

6.10	DATUM TRANSFORMATIONS	6-44
6.11	DOCUMENTATION.....	6-45
6.12	REFERENCES.....	6-45
7.	CONTROL NETWORK DENSIFICATION AND EXTENSION	7-47
7.1	INTRODUCTION.....	7-48
7.2	MONUMENTATION	7-50
7.2.1	Horizontal Control Stations.....	7-50
7.2.1.1	CORS	7-50
7.2.1.2	HARN	7-50
7.2.2	Vertical Control Stations.....	7-50
7.3	MINIMUM STANDARDS	7-50
7.3.1	Horizontal Geodetic Control Standards.....	7-50
7.3.2	Vertical Geodetic Control Standards	7-50
7.4	FIELD PROCEDURES.....	7-51
7.4.1	Horizontal Geodetic Control Field Procedures	7-51
7.4.2	Vertical Geodetic Control Field Procedures	7-51
7.5	DATA PROCESSING	7-51
7.6	QUALITY CONTROL	7-51
7.7	DOCUMENTATION.....	7-51
7.8	REFERENCES.....	7-52
8.	PRIMARY PROJECT CONTROL	8-53
8.1	INTRODUCTION.....	8-54
8.2	MONUMENTATION	8-56
8.3	MINIMUM STANDARDS	8-56
8.3.1	Primary Horizontal Project Control Standards.....	8-56
8.3.1.1	Azimuth Pairs	8-56
8.3.2	Primary Vertical Project Control Standards.....	8-57
8.4	PROCEDURES	8-57
8.4.1	Primary Horizontal Project Control Procedures.....	8-57
8.4.1.1	Equipment	8-57
8.4.1.2	Techniques	8-57
8.4.1.3	Network Design	8-58
8.4.2	Primary Vertical Project Control Procedures.....	8-65
8.4.2.1	Differential Leveling	8-65
8.4.2.2	Trigonometric Leveling	8-65
8.4.2.3	GPS Leveling.....	8-68
8.5	DATA PROCESSING	8-69
8.5.1	Horizontal	8-69
8.5.2	Vertical	8-71
8.5.2.1	Differential Leveling	8-71
8.5.2.2	Trigonometric Leveling	8-71
8.5.2.3	GPS Leveling.....	8-71
8.6	QUALITY CONTROL	8-73
8.7	REPORTING	8-73
8.7.1	Field Notes	8-73
8.7.1.1	Horizontal	8-73
8.7.1.2	Vertical.....	8-73
8.7.2	Survey Reports.....	8-73

TABLE OF CONTENTS

8.7.2.2	Vertical.....	8-75
8.8	REFERENCES.....	8-77
9.	SECONDARY PROJECT CONTROL	9-79
9.1	INTRODUCTION.....	9-80
9.2	MONUMENTATION	9-81
9.2.1	Baseline Stations.....	9-81
9.2.2	Bench Marks	9-82
9.3	MINIMUM STANDARDS	9-82
9.3.1	Secondary Horizontal Project Control Standards.....	9-82
9.3.1.1	GPS Techniques	9-82
9.3.1.2	TPS Techniques	9-82
9.3.2	Secondary Vertical Project Control Standards	9-83
9.4	PROCEDURES	9-83
9.4.1	Secondary Horizontal Project Control Procedures	9-84
9.4.1.1	GPS Procedures:.....	9-84
9.4.1.2	TPS Procedures	9-85
9.4.2	Secondary Vertical Project Control Procedures	9-87
9.4.2.1	Differential Leveling	9-87
9.5	DATA PROCESSING	9-89
9.5.1	Horizontal	9-89
9.5.1.1	GPS	9-89
9.5.1.2	TPS.....	9-89
9.5.2	Vertical	9-90
9.5.2.1	Differential Leveling	9-91
9.5.2.2	Trigonometric Leveling	9-91
9.6	QUALITY CONTROL	9-91
9.7.1	Field Notes	9-91
9.7.1.1	Horizontal	9-91
9.7.1.2	Vertical.....	9-91
9.7.2	Survey Reports.....	9-91
9.7.2.1	Horizontal	9-92
9.7.2.2	Vertical.....	9-93
9.9	REFERENCES.....	9-94
10.	PHOTOGRAMMETRIC CONTROL SURVEYS	10-95
10.1	INTRODUCTION.....	10-97
10.2	MONUMENTATION	10-98
10.3	MINIMUM STANDARDS	10-98
10.3.1	Photogrammetric Horizontal Control Standards.....	10-98
10.3.1.1	GPS Techniques.....	10-98
10.3.1.2	TPS Techniques	10-98
10.3.2	Photogrammetric Vertical Control Standards	10-98
10.3.2.1	Differential Levelling Techniques.....	10-98
10.3.2.2	TPS Techniques	10-98
10.3.2.3	GPS Techniques.....	10-99
10.4	PROCEDURES	10-99
10.4.1.1	GPS Techniques.....	10-99
10.4.1.2	TPS Technique	10-104
10.4.2	Vertical.....	10-106

TABLE OF CONTENTS

10.4.2.1	Differential Leveling Technique	10-106
10.4.2.2	TPS Technique	10-106
10.4.2.3	GPS Technique	10-106
10.5	DATA PROCESSING	10-107
10.5.1	Horizontal	10-107
10.5.1.1	GPS	10-107
10.5.1.2	TPS.....	10-107
10.5.2	Vertical.....	10-107
10.5.2.1	Differential Leveling	10-107
10.5.2.2	TPS.....	10-108
10.5.2.3	GPS	10-108
10.6	QUALITY CONTROL	10-108
10.7	REPORTING	10-108
10.7.1	Field Notes	10-108
10.7.1.1	Horizontal.....	10-108
10.7.1.2	Vertical.....	10-108
10.7.2	Survey Reports.....	10-108
10.7.2.1	Horizontal.....	10-109
10.7.2.2	Vertical.....	10-109
10.8	REFERENCES.....	10-109
11.	TERRAIN DATA (TOPOGRAPHIC) SURVEYS	11-110
11.1	INTRODUCTION.....	11-111
11.2	ALTERNATIVE TERRAIN DATA COLLECTION SYSTEMS	11-112
11.3	MINIMUM STANDARDS	11-112
11.3.1	Point Features	11-112
11.3.2	Linear Features	11-112
11.3.3	DTM Features.....	11-112
11.4	FIELD PROCEDURES.....	11-112
11.4.1	Feature Location Procedures	11-112
11.4.2	Feature Naming.....	11-116
11.4.3	DTM Procedures	11-121
11.5	DATA PROCESSING	11-128
11.6	MERGING DTMS	11-129
11.7	FEATURE ATTRIBUTES	11-129
11.8	ADJUSTMENTS.....	11-130
11.9	SUPPLEMENTAL DTM DATA FOR PHOTOGRAMMETRY.....	11-130
11.9.1	DEFINITIONS.....	11-130
11.9.2	APPROPRIATE AREAS FOR SDTM DATA	11-131
11.9.3	DATA FILE INTEGRITY	11-131
11.9.4	SCHEDULE	11-131
11.10	QUALITY CONTROL	11-132
11.11	SURVEY RECORDS.....	11-132
11.11.1	FIELD NOTES.....	11-132
11.12	REFERENCES.....	11-132
12.	RIGHT OF WAY (ROW) MAPPING SURVEYS	12-133
12.1	INTRODUCTION.....	12-135
12.2	MINIMUM STANDARDS	12-135
12.2.1	Point Feature Accuracy Standards.....	12-135

TABLE OF CONTENTS

12.2.2	Linear Feature Accuracy Standards	12-135
12.3	FIELD RESEARCH	12-136
12.3.1	Verification of Record Evidence	12-136
12.3.2	Interviews of Property Owners & Local Residents	12-137
12.3.3	Search for Unrecorded Monuments	12-137
12.3.4	Monument Perpetuation	12-138
12.3.5	Analysis	12-138
12.4	FIELD PROCEDURES	12-138
12.4.1	Point Feature Location Procedures	12-138
12.4.1.1	Set-up	12-138
12.4.1.2	Operation	12-139
12.4.2	Radial Surveying Techniques	12-139
12.4.2.1	Existing Feature (well defined)	12-139
12.4.2.2	Existing Feature (marginally defined)	12-139
12.4.2.3	Side Traverses	12-140
12.4.3	Linear Feature Location Procedures	12-141
12.5	SURVEY RECORDS	12-141
12.5.1	Research Records	12-141
12.5.2	Field Notes	12-143
12.6	REFERENCES	12-143
13.	BRIDGE AND HYDRAULIC SURVEYS	13-144
13.1	BRIDGE LOCATION REQUIREMENTS	13-145
13.1.1	Types of Bridge Projects	13-145
13.1.2	New and Replacement Bridges	13-145
13.1.3	Replacement Bridges	13-145
13.2	WATERWAY HYDRAULIC REQUIREMENTS	13-148
13.2.1	Introduction	13-148
13.2.2	Site Data	13-148
13.2.3	Cross Sections Required for Scour Susceptibility Study	13-149
13.2.4	Additional Information	13-150
14.	RAILROAD SURVEYS	14-151
14.1	SAFETY	14-152
14.2	PROCEDURES	14-152
15.	CONSTRUCTION SURVEYS	15-153
15.1	RE-ESTABLISHMENT OF PROJECT CONTROL	15-154
15.2	ESTABLISHING PERMANENT SURVEY MARKERS (PSM'S) AND ROW MARKERS	15-154
15.3	CORRECTIONS AND ADJUSTMENTS	15-154
15.4	CONSTRUCTION STAKEOUT	15-154
16.	FIELD EDITS OF PHOTOGRAMMETRIC MAPPING	16-157
17.	APPENDIX	17-161
17.1	SURVEY CLASSIFICATIONS AND ACCURACY STANDARDS	17-163
17.2	VACANT	17-165
17.3	HIGHWAY LAW, SECTION 30, PARAGRAPH 17	17-167
17.4	EMINENT DOMAIN PROCEDURE LAW, SECTION 404	17-168
17.5	RIGHT OF ENTRY FORM HC 176	17-169
17.6	"SURVEYING ON RAILROAD PROPERTY" Memo	17-171
17.7	DESCRIPTION OF TERMS	17-173

TABLE OF CONTENTS

17.8	INDEX	17-177
17.9	TABLE OF FIGURES	17-181

1. INTRODUCTION

1.1 PURPOSE

Surveying is a basic element of all civil engineering projects. Surveying is “the science of making precise measurements between known and unknown points, applying the principals of mathematics to determine positional locations at a required accuracy, and the art of publishing mapping products which meet the needs of the customer”. Surveying determines the geospatial locations of points or objects (features) on or near the surface of the earth, for the purpose of graphically portraying the relative positions of terrain data and geometrically calculating their coordinates and elevations.

In transportation engineering, surveying provides the foundation and continuity for route location, land appropriation, and design and construction of capital projects. Surveys establish a basic "network" of horizontal and vertical control which are valuable in the stakeout of proposed engineered designs during the construction, and for any future re-establishment of that terrain or highway right of way.

The purpose of this manual is to describe the required standards, accepted procedures and performance criteria to be used by the New York State Department of Transportation (NYSDOT) and its agents when conducting surveys. Survey standards, procedures and performance criteria provide consistency of survey accuracy and reliability of mapping products for the customer.

The information included in this manual has been developed in conformance with applicable department directives, policies and procedures, as well as nationally accepted geodetic surveying standards and practices. This manual is neither a textbook nor a substitute for surveying knowledge, experience or professional judgment. It is intended to establish minimum NYSDOT surveying standards, provide uniform procedures for implementing survey best practices, assure quality and continuity in collection of survey data, and assure compliance with Federal and State performance criteria.

NYSDOT has produced different manuals during its history relating to Surveying. An earlier publication entitled “General Specifications for Surveying & Mapping for Highway Purposes” was published in 1967. A draft “Surveying Manual” was written in 1974-75, but not published. The first version of the “Surveying Standards & Procedures Manual” was published in 1994, and was revised in 1996. The current version of the “Land Surveying and Procedures Manual” was first published in 2005.

This 2009 version includes both metric and US customary units, updates procedures for use of RTK GPS, and updates the required coordinate system datums and reference network.

This revised manual requires the use of the NYS Spatial Reference Network (NYSNet). NYSNet is a spatial reference network of continuously operating Global Positioning System (GPS), reference stations (CORS) throughout NYS that can be used for differential GPS applications.

1.2 STANDARDS

The standards specified in this manual were selected to assure a consistent precision and accuracy in all of the measurements, coordinates, elevations, base mapping, digital terrain models (DTM) and survey reports upon which design engineering and ROW mapping are based. The surveyor shall certify that the required standards and specifications have been achieved.

*Beginning in 2009 the department is transitioning to US customary units (USC). During this transition, units will be determined on a project basis. The regional land surveyor should be consulted to determine whether a specific project is designated a metric or US customary project. During this transition, US customary units have been added to this manual.

The following measurement unit conventions shall be used on all NYSDOT surveys:

Length or distance measurements shall be in **US survey feet (formerly meters)**.

Area units shall be described in **square feet (formerly square meters)**.

Angular measurements shall be in **degrees, minutes, seconds**.

Control line & boundary line directions shall be described by **bearings**.

Geodetic Surveying standards have been traditionally expressed in meters. Where geodetic surveying standards within this manual make reference to federal standards, they may continue to be expressed in metric units.

1.3 PROCEDURES

The recommended procedures are those that adequately support conformance to the established standards.

All survey equipment, including tripods, tribrachs, prisms, etc. shall be properly maintained and calibrated according to manufacturers' guidelines. The [National Geodetic Survey \(NGS\) calibration baselines](#), established specifically for the checking of Electronic Distance Measuring Instruments (EDMI) may be used for checking the calibration of EDM's. Equipment calibration records and reports (not exceeding one year) shall be maintained by the surveyor and submitted to the Department as requested.

Whenever a surveyor faces a unique situation which warrants departure from the procedures described in this manual, the proposed alternative procedures need to be documented and submitted to the [Regional Land Surveyor](#) for review and approval. Documentation shall include testing and reporting of the resulting positional accuracy according to the [Spatial Positioning Accuracy Standards Chapter](#) of this manual.

1.4 REFERENCES

1. NYSDOT [ROW Mapping and Procedure Manual](#)
2. NYSDOT [CADD Standards and Procedure Manual](#)
3. [Calibration Baselines in NYS](http://www.ngs.noaa.gov/CBLINES/BASELINES/ny) <http://www.ngs.noaa.gov/CBLINES/BASELINES/ny>

2. SURVEY SAFETY

SURVEY SAFETY

2.1 INTRODUCTION

The safety of survey personnel and the public shall always be a high priority during all field operations conducted for Departmental work. Safety related policy for surveying operations shall conform to the Federal Manual of Uniform Traffic Control Devices regarding Temporary Traffic Control. This chapter is intended to document and supplement safety policy by providing safe operating procedures, guidelines, and practices, specific to NYSDOT surveying operations.

Most DOT surveys deal with working along and/or within roadways. The traffic on the highway is the biggest danger to a DOT survey crew. Survey safety should always consider potential traffic hazards no matter how unlikely they are to occur.

This Chapter provides supplemental requirements and information to the following:

1. Part six (6), Temporary Traffic Control, of the National Manual of Uniform Traffic Control Devices (MUTCD)
[National MUTCD](#)
2. NYSDOT Transportation Maintenance Safety Manual,
[Transportation Maintenance Safety Manual](#)
3. Existing NYSDOT safety bulletins, for NYS Employees, see:
[Safety Bulletin Index](#)
4. Supplement the Construction Program Employee Safety Manual
[Construction Program Employee Safety Manual](#)
5. NYS Supplement the National Manual of Uniform Traffic Control Devices (MUTCD)
[NYS Supplement to National MUTCD](#)

Safety should always be considered before the start of the survey. The survey crew chief should discuss safety considerations with the Regional Land Surveyor or the designated survey supervisor prior to conducting the survey. The NYSDOT regional safety representative or the Employee Safety and Health Section in the Main Office can provide guidance and information and can arrange training on a wide array of safety related issues. They also maintain a listing of current safety bulletins available through the Department. Relevant topics currently covered by NYSDOT safety bulletins include: vehicles and equipment, work clothing guidelines, cold weather hazards, working near railroads, confined space entry, and fall protection. Contact the NYSDOT regional safety representative or the Employee Safety and Health Section in the Main Office, (518) 457-2420, for complete information.

2.2 DEPARTMENT SAFETY AND HEALTH POLICY

NYSDOT is committed to ensure minimal risk for its employees, for the employees of contractors and consultants, and to protect the public exposed to transportation operations. To achieve these goals, the Department establishes and monitors policies and procedures to ensure that internal operations and interaction with private firms, utilities, and government agencies are planned and carried out with an emphasis on safety and health. This emphasis must include personal and active involvement by every member of the Department, and originate from the commitment of executive management. Managers and supervisors have a proprietary responsibility for the safety of those with whom the department conducts business, and for the safety of the public. The Department invites utilities, commercial vehicle operators, rail lines, public transportation

SURVEY SAFETY

agencies, and local governments to become equal partners in ensuring that the department of Transportation accomplishes its mission in a safe manner.

2.3 TRAFFIC CONTROL

In addition to following available guidance, efforts should be made to conduct the survey in a way that minimizes hazards to the survey crew and the public. Survey Baselines should be located off of the roadway whenever possible. Effort should be made to keep the Survey Baselines on one side of the roadway so as to isolate encroachments on the roadway. When working in the roadway is necessary, additional traffic control may be necessary.

Prior to starting a survey the survey crew chief should meet with the survey supervisor to discuss what traffic control measures are necessary for conducting the survey. Work Zones shall be established according to **Part 6 of the National MUTCD**.

Example Applications of Traffic Control Devices:

The following are typical applications of traffic control devices based on Part 6 of the National MUTCD for a variety of situations commonly encountered during surveying operations. While not every situation can be addressed, the information listed here and in Part 6 of the National MUTCD can generally be adapted to a broad range of conditions. In many instances, an appropriate traffic control plan is achieved by combining features from various typical applications. For example, while establishing a work zone for traversing down the shoulder of a road, a crew may also have to make observations in the centerline of the roadway or on the opposite side of the roadway. The work zone may have to be changed during the operation to address these changing work areas.

Refer to Part 6 of the National MUTCD for Traffic Control Device Standards, guiding principles, statutes, and definitions of words and phrases, etc.

Refer to Part 6 of the National MUTCD for sign and cone placement standards.

Refer to Safety Bulletin 07-5 for Vehicle Warning Lighting Standards.

SB-07-5 Vehicle Warning Lighting Standard

A typical survey may progress as follows:

2.3.1 Reconnaissance Survey off of the roadway

Typical Traffic Control

Minimum Traffic Control Devices:

Vehicle Warning Lighting (Refer to SB-07-5 Vehicle Warning Lighting Standard)

Additional Traffic Control Devices which may be used:

Work Zone Ahead signs (if parking on roadway.)

Refer to Part 6 of the National MUTCD for example application of devices.

Application Notes:

The ROAD WORK AHEAD sign may be replaced with other appropriate signs such as the SHOULDER WORK sign, if the shoulder is occupied. The SHOULDER WORK sign may be used for work adjacent to the shoulder.

If the work space is in the median of the roadway of a divided highway, an advance warning sign should also be placed on the left side of the roadway.

SURVEY SAFETY

2.3.2 Project Control Survey

Typical Traffic Control

Minimum Required Traffic Control Devices:

Vehicle Warning Lighting (Refer to SB-07-5 Vehicle Warning Lighting Standard)

Work Zone Ahead signs

Additional Traffic Control Devices which may be used:

No Shoulder Signs (May be used if vehicles or equipment are on shoulder of road)

Refer to Part 6G of the National MUTCD for example application of devices.

2.3.3 Terrain Data Survey

Typical Traffic Control

Minimum Required Traffic Control Devices:

Vehicle Warning Lighting (Refer to SB-07-5 Vehicle Warning Lighting Standard)

Work Zone Ahead signs

Additional Traffic Control Devices which may be used:

No Shoulder Signs (May be used if setups or vehicles or equipment are on shoulder of road)

Flagger Signs and Flagger (may be used if working in roadway and Flagger is present)

Stop traffic (may be used if working in roadway of high volume road)

Refer to Part 6G of the National MUTCD for example application of devices.

Refer to Safety Bulletin SB-95-8 WORK ZONE ENHANCEMENTS FOR SHOULDER WORK

Application Notes:

A flagger or spotter should be used to warn workers who cannot watch road users.

For surveying on the centerline of a high volume road, one lane shall be closed.

A high-level warning device (flag tree) may be used to protect a surveying device, such as a target on a tripod.

ROAD WORK AHEAD signs should be used in place of the SURVEY CREW AHEAD signs.

Flags should be used to call attention to the advance warning signs.

For a survey along the edge of road or along the shoulder, cones should be placed along the edge line.

Refer to Part 6G of the Federal MUTCD for example application of devices for multiple lanes, intersections, interstates etc.

2.4 SAFETY EQUIPMENT

At a minimum each NYSDOT survey crew member should be equipped with Personal Safety Equipment including vest, hard hat, and proper work shoes and clothing as described in applicable safety bulletins:

At a minimum each NYSDOT survey crew shall have access to necessary Traffic Control devices including:

Work Zone Ahead Signs of appropriate size

No Shoulder Ahead Signs of appropriate size

Flag Person Ahead Signs of appropriate size

Flags

SURVEY SAFETY

Paddles
Traffic Cones

2.5 SAFE PRACTICES

All new NYSDOT Survey Crew members shall receive a Safety Orientation arranged by their supervisor.

NYSDOT field employees shall be provided access to this manual, the transportation maintenance safety manual, the National MUTCD, Construction Program Employee Safety Manual and all safety bulletins.

No survey operation shall be considered as too important or urgent as to compromise safe practices.

When any operation becomes hazardous beyond reason due to unforeseen or uncontrollable circumstances, operations should cease until safe conditions have been restored.

2.6 INDIVIDUAL RESPONSIBILITIES

Field employees are expected to do everything reasonable to protect the health and safety, of themselves, their coworkers, and the safety of the public.

Field employees shall only report to work when they are physically able to perform their duties.

Crew members expected to operate vehicles shall possess the appropriate motor vehicle license. Individuals without a motor vehicle license will not operate the vehicle(s). Crew Members are expected to be familiar with all applicable Safety Bulletins.

Every crew member will be familiar with the first aid section of the NYSDOT Transportation Maintenance Safety Manual and, when working on construction sites, Construction Program Employee Safety Manual.

Crew members will not enter confined spaces until they have been trained and equipped to do so. [SB-04-03 Permit Required Confined Spaces](#) and, when working on construction sites, Construction Program Employee Safety Manual.

SURVEY SAFETY

2.7 SURVEY CREW CHIEF RESPONSIBILITIES

Survey Crew Chiefs are responsible for insuring safe operating procedures by crew members, instructing crew members on safe work practices, enforcing safety policy, and setting a positive example. If any safety policies are unclear, they should inquire with the Regional Safety Officer for clarification. Survey Crew Chiefs are required to read and practice all advisements, cautions or warnings which pertain to survey operations, as listed in Section 2.1 above.

Survey Crew Chiefs are responsible for ceasing operations if they become hazardous due to unforeseen or uncontrollable circumstances. These incidents shall be reported to the Survey Supervisor or Regional Land Surveyor. If crew member's actions are unsafe, they shall be instructed appropriately by the Crew Chief and reported to the Regional Land Surveyor.

Tools and equipment will only be used for their intended purpose, and only used when in proper condition. Crew members will be trained in their use, or will not use them.

2.8 SURVEY SECTION SUPERVISOR RESPONSIBILITIES

When planning survey operations, safety considerations shall be given first priority. Such considerations will include, but not be limited to, the optimum time of day (or season) to accomplish a particular job, assignment of more experienced personnel for more potentially hazardous jobs, special work zone protection and traffic control requirements, and discussion of any recent accident, its cause and appropriate corrective action. Alternative surveying techniques should also be discussed.

Survey supervisors will conduct periodic safety training, "tailgate safety meetings", as necessary. Subjects will include review of appropriate manual sections (as determined by seasonal or special job considerations; i.e. working near railroads, rivers, heights, etc); review of new or appropriate department safety policies; safety orientation for new employees; and continuous review of proper first aid techniques. [SB-7-2 Seasonal Safety Training](#).

Survey supervisors are responsible to assure the survey crew has the necessary tools, safety equipment, and training needed to comply with this guidance. The supervisor is also responsible for addressing safety concerns as they arise to assure the survey is not conducted under unsafe conditions. Survey Supervisors are required to read, promote and enforce all advisements, cautions or warnings which pertain to survey operations, as listed in Section 2.1 above.

Each survey crew should have at least one member trained in basic first aid.

Each crew will have a fully supplied first aid kit, including a copy of the "Good Samaritan" Law.

3. PUBLIC RIGHTS AND NOTIFICATION

PUBLIC RIGHTS AND NOTIFICATION

3.1 INTRODUCTION

NYSDOT field employees are sometimes the only representatives of the Department that the majority of the public ever meets or observes at work. Field employees are the ones who establish the reputation of the Department.

3.2 COURTESY

NYSDOT is a service organization. The Department provides services for commuters, other travelers and commercial haulers. Services are provided for anyone who lives or travels within the state. These residents and travelers are our customers. Therefore, any interaction with them should be done with courtesy and respect.

The surveyor needs to minimize the use of paint and flagging and avoid any negatively perceived impact to private property.

3.3 WHAT TO DIVULGE

People who live on or near the project are those with whom the surveyor will have the most contact. They will want to know what the surveyors are doing, why, to what end, and how their lives and property will be affected.

Questions about the Department's operations, procedures, instruments and products may be answered without reservation. Questions about why surveyors are there should be answered in as straight-forward professional manner as possible. Questions about a final design or possible right-of-way acquisition always should be referred to the Regional Design Engineer.

3.4 RIGHT OF ENTRY

[Section 30, Paragraph 17](#), of the [Highway Law](#) authorizes NYSDOT personnel and consultant surveyors acting on behalf of NYSDOT the right to "enter upon property for the purpose of making surveys ..." [Section 404](#) of the [Eminent Domain Procedure Law](#) repeats this authority.

While the Department may have a legal right to enter private property, it is important for the surveyor to use courtesy when doing so. The surveyor should attempt to notify the property owner in advance, especially when the occupation of the land will be for a prolonged length of time or when it extends very far onto the property.

Survey supervisors provide their crew chiefs with letters of introduction that explain a region's rights and policies in such matters. Some of these letters further explain that, while the region would like to notify each owner individually, it can be inefficient use of limited staff resources to notify owners of possible entries that will last only a few minutes. See an example form letter in [appendix 17.5](#).

If an owner or tenant objects to entry or orders the surveyor off the property, the surveyor should comply and report the incident to the regional survey supervisor.

PUBLIC RIGHTS AND NOTIFICATION

3.5 CORPORATE PROPERTY

The Department's rights-of-entry extend to corporate as well as private property. This right may be exercised if necessary. However, entry upon corporate property offers a greater likelihood of hazards to members of the survey party. There is also the possibility of interfering with costly operations, or compromising the imposed security of a facility. Extra effort should be made to notify managers if there will be entry upon corporate property.

This is especially true in the case of railroads. Even when a railroad employee merely perceives that we are endangering ourselves or their operations, the result can be costly delays. If the work area on a railroad includes the right-of-way area, the railroad should be notified in advance through the regional railroad coordinator.

All NYSDOT surveyors are required to carry a NYSDOT photo ID.

4. CREW COMPOSITION, PERSONNEL, AND EQUIPMENT

CREW COMPOSITION, PERSONNEL, AND EQUIPMENT

4.1 PERSONNEL

A typical full time NYSDOT survey party normally consists of 2-4 personnel depending on project survey and site safety requirements. Survey parties may be augmented with additional personnel, e.g., construction personnel, as needed to meet project requirements.

Each survey party needs to be trained and equipped to perform all types and grades of terrestrial surveys which are routinely required by NYSDOT. The most productive technologies available are to be used.

4.2 EQUIPMENT

Standard survey crew equipment is defined as equipment typically required to complete all types of NYSDOT survey tasks. It is not to be considered a minimum, maximum or exhaustive list. This list should be modified to meet specific project requirements. This should allow for flexibility in adding tools, accessories, and personnel to meet local conditions and requirements.

The standard list does not include consumable supplies. Each office should select the items and quantities best suited to meet its requirements.

For each regional survey group:

- 4 Geodetic Dual Frequency GPS receivers, w/ 2 kinematic rover setups, accessories and software.
- 4 Fixed Height GPS Tripods
- 1 Mapping Grade sub meter GPS RTK receiver with accessories and software
- 1 or 2 hand held GPS receivers with accessories and software

For each standard survey party:

Vehicles:

Each standard party is equipped with two four-passenger 3/4 ton utility vehicles.

Automation equipment:

- 1 High End Laptop PC
- 1 Docking station with CADD Monitor, keyboard and mouse and network connection.
- 1 Printer

CREW COMPOSITION, PERSONNEL, AND EQUIPMENT

Surveying instruments and equipment:

- 1 Automatic total station, charger, spare battery, vehicle power adapter, etc.
- 1 Electronic data collector, charger
- 1 Digital level/ bar code rod or Automatic Level, with accessories and software.
- 1 Portable, rechargeable text printer
- 3 Two-way radios, charger for each, spare battery, external speaker microphone
- 1 Magnetic locator
- 4 Tripods
- 4 Tribrachs with optical plummet
- 6 Retro reflective prisms
- 4 Single prism holders with targets
- 4 Rotatable tribrach adapters
- 1 Three prism holder
- 2 Prism poles, telescoping

- 1 Auxiliary battery (brick)
- 1 Auto converter (power transformer)
- 2 6 ft folding rules (2 meter folding rules)
- 1 50 ft steel tape (30 meter steel tape)
- 1 100 ft fiberglass tape
- 1 200 ft steel tape
- 1 25 ft, level rod (4.5 meter and 7 meter level rods)
- 1 Clinometer
- 1 Compass

Tools:

- 1 Sledge hammer, assorted chisels
- 1 Shovel and spade
- 2 Machetes
- 1 Hatchet
- 1 Lopping shear and pruning saw
- 1 Rebar driver
- 1 Plumb Bob

Safety equipment (typical):

- Work zone signs
- Cones
- Flags
- 1 Cellular Phone
- 1 First aid kit
- 1 Fire extinguisher
- 1 Jumper cables
- 1 Steel flammables box (for target paint and spray cans)
- 1 Tow chain

(Refer to the referenced work site safety manuals for complete requirements)

CREW COMPOSITION, PERSONNEL, AND EQUIPMENT

Personal safety clothing (State issued for NYSDOT personnel) for each crew member:

- 1 Orange coat or jacket
- 1 Safety vest
- 3 (min) Orange shirts
- 1 Orange hard-hat
- 1 Orange rain suit or coat
- 1 Rubber boots (pair)

5. SPATIAL POSITIONING ACCURACY STANDARDS

SPATIAL POSITIONING ACCURACY STANDARDS

5.1 INTRODUCTION

The standards and procedures in this manual are written to assure the spatial positioning accuracy standards as established by the [Federal Geographic Data Committee](#) (FGDC) are achieved. These [Federal Geographic Data Committee](#) standards define accuracy that is to be evaluated.

The **local accuracy** of a control point is a value that represents the uncertainty in the coordinates of the control point relative to the coordinates of other directly connected, adjacent control points at the 95-percent confidence level. The reported local accuracy is an approximate average of the individual local accuracy values between this control point and other observed control points used to establish the coordinates of the control point.

The **network accuracy** of a control point is a value that represents the uncertainty in the coordinates of the control point with respect to the geodetic datum at the 95-percent confidence level. For NSRS network accuracy classification, the datum is considered to be best expressed by the geodetic values at the Continuously Operating Reference Stations (CORS) supported by NGS. By this definition, the local and network accuracy values at CORS sites are considered to be infinitesimal, i.e., to approach zero.

5.2 STANDARDS

The positional accuracy standards for NYSDOT survey products are included in appendices [17.1 SURVEY CLASSIFICATIONS AND ACCURACY STANDARDS](#)

The standards specified in this manual are intended to meet or exceed the standards specified in:

1) [Geospatial Positioning Accuracy Standard, Part 2, Geodetic Control Networks](#), FGDC-STD-007.2-1998

And

2) [Geospatial Positioning Accuracy Standard, Part 4: Architecture, Engineering Construction and Facilities Management](#), FGDC-STD-007.4-2002

5.3 PROCEDURES

The procedures specified in this manual are based on proven technology and experience that has been demonstrated to meet the above referenced standards.

If varying from the procedures or technology specified in this manual, the positional accuracy of such techniques must be tested and reported as specified in

1) [Geospatial Positioning Accuracy Standard, Part 1, Reporting Methodology](#), FGDC-STD-007.1-1998

SPATIAL POSITIONING ACCURACY STANDARDS

And

2) *Geospatial Positioning Accuracy Standard, Part 3, National Standard for Spatial Data Accuracy*, FGDC-STD-007.3-1998

When specifying standards and procedures for other types of surveys to be completed for NYSDOT, consideration should be given to achieving the spatial positioning accuracy required for the project.

Consideration should also be given to the accuracy requirements of other NYSDOT users of this information. For minimal additional cost it may be possible to collect data to a higher positional accuracy that may make the information useful to other NYSDOT users.

Common levels of Spatial Positioning Accuracy:

Accuracy 95-Percent Classification Confidence
 Less Than or Equal to:

5 Hundredths	0.05 feet
1 Tenth	0.1 feet
2 Tenths	0.2 feet
½ foot	0.50 feet
1-foot	1.00 foot
2-feet	2.00 feet
5-feet	5.000 feet
10-feet	10.000 feet

Note: although the largest entry in Table is 10 feet, the accuracy standards can be expanded to larger numbers if needed.

Accuracy 95-Percent Classification Confidence
 Less Than or Equal to:

2-Centimeter	0.020 meters
5-Centimeter	0.050 meters
1-Decimeter	0.100 meters
2-Decimeter	0.200 meters
5-Decimeter	0.500 meters
1-Meter	1.000 meters
2-Meter	2.000 meters
5-Meter	5.000 meters
10-Meter	10.000 meters

Note: although the largest entry in Table is 10 meters, the accuracy standards can be expanded to larger numbers if needed

When points in a survey are classified, they have been verified as being consistent with all other points in the network, not merely those within that particular survey. It is not observation closures within a survey which are used to classify control points, but the

SPATIAL POSITIONING ACCURACY STANDARDS

ability of that survey to duplicate already established values. This comparison takes into account systematic effects known to influence survey measurements.

5.4 DATA COLLECTION METHODS

When specifying standards and procedures for other types of surveys to be completed for NYSDOT, consideration should be given to providing deliverable file formats that meet the needs of the customer in a format compatible with NYSDOT systems. Consideration should also be given to other possible users of the data.

Equipment and procedures should be specified that will ensure the standards for the survey are achieved. Equipment and procedures should be tested according to the Standards listed under [Section 5.3](#) of this manual under actual field conditions typical of the environments they will be used in. Many manufacturer specifications are achievable only under ideal conditions.

5.4.1 GPS Data Collection Methods

Autonomous Positioning

Also referred to as Stand Alone, Point, or Absolute Positioning. GPS method by which only one receiver is employed, position is determined from satellite observations only. Accuracy of about **30 ft (10 meters)**. Recreational GPS receivers rely on this method.

Differential Positioning

Also referred to as relative positioning. GPS method by which two receivers are employed. One receiver is on a known station (base), one receiver is on an unknown station (rover). By observing common satellites simultaneously, GPS errors can be determined at the base station and applied to the roving station. There are differential correction services available that can provide differential corrections. Accuracy can be from **2 ft. to 15 ft. (.5 meter to 5 meters)** depending upon the receiver technology and accuracy of the differential corrections.

Carrier phase positioning

Also referred to as survey grade GPS. Method by which carrier phase GPS signals are used along with Differential positioning techniques to achieve survey grade <.05 ft. (< 1cm) positions.

Real Time Differential Corrections

Method by which differential corrections are received and applied in real time.

5.5 REFERENCES

1. [Geospatial Positioning Accuracy Standard, Part 2, Geodetic Control Networks](#), FGDC-STD-007.2-1998
2. [Geospatial Positioning Accuracy Standard, Part 4: Architecture, Engineering Construction and Facilities Management](#), FGDC-STD-007.4-2002
3. [Geospatial Positioning Accuracy Standard, Part 1, Reporting Methodology](#), FGDC-STD-007.1-1998
4. [Geospatial Positioning Accuracy Standard, Part 3, National Standard for Spatial Data Accuracy](#), FGDC-STD-007.3-1998

6. NYS DOT COORDINATE SYSTEMS AND DATUMS

NYS DOT COORDINATE SYSTEMS AND DATUMS

6.1 INTRODUCTION

Surveys are performed on the irregular surface of the earth, and are then transformed into a plane rectangular coordinate system for ease of use in engineering and surveying computations. In a state as large as New York, there is a need for a consistent, accurate, and documented system so that surveys performed for NYSDOT are related in a standardized system. This requires a well-defined coordinate system and datums, which NGS has developed and NYS has adopted. This coordinate system and datums will provide NYSDOT with a consistent, accurate, and reproducible system, which will protect the interests of the People of the State of New York.

There may be exceptions to the standards specified below. The coordinate system and datums for each project should be reviewed with the Regional Land Surveyor.

6.2 REFERENCE SYSTEM

Surveys for NYSDOT shall be connected to the NYS Spatial Reference Network (NYSNet). NYSNet is a network of continuously operating Global Positioning System (GPS), reference stations (CORS) throughout NYS that can be used for differential GPS applications. NYSNet is part of the National Spatial Reference System (NSRS), maintained by the National Geodetic Survey.

The National Spatial Reference System (NSRS) is a consistent coordinate system that defines latitude, longitude, height, scale, gravity, and orientation throughout the United States, and how these values change with time. NSRS comprises:

- 1) A consistent, accurate, and up-to-date national shoreline;
- 2.) A set of Global Positioning System (GPS) Continuously Operating Reference Stations (CORS) meeting NOAA standards for installation, operation, and data distribution;
- 3.) A network of permanently marked points including the Federal Base Network (FBN), and Cooperative Base Network (CBN), commonly called the High Accuracy Reference Network (HARN), User Densification Network; and a set of accurate models describing dynamic geophysical processes that affect spatial measurements.

NSRS provides a highly accurate, precise, consistent geographic framework throughout the United States. It is the foundation for the National Spatial Data Infrastructure, a critical component of the information superhighway. NSRS is a significant national resource - one whose value far exceeds its intended purpose.

6.3 COORDINATE SYSTEM

Because of the complexity of performing the calculations for geodetic surveying and the limited extent of most surveying projects, most surveyors generally use plane surveying techniques. For local projects of limited extent, plane surveying yields accurate results, but for large projects locally administered plane surveying systems may not be adequate. Not only can locally administered plane coordinate systems be inaccurate over large areas, but they cannot be easily related to other local systems.

NYSDOT COORDINATE SYSTEMS AND DATUMS

In response to the needs of local surveyors for an accurate plane surveying coordinate system useful over relatively large areas, the U. S. Coast and Geodetic Survey (the predecessor of NGS) developed the State Plane Coordinate System in 1934.

The State Plane Coordinate System was established to provide a means for transferring the geodetic positions of monumented points to plane coordinates that would permit the use of these monuments in plane surveying over relatively large areas without introducing significant error.

A plane-rectangular coordinate system is by definition a flat surface. Geodetic positions on the curved surface of the earth must be “projected” to their corresponding plane coordinate positions. Projecting the curved surface onto a plane requires some form of deformation. Imagine the stretching and tearing necessary to flatten a piece of orange peel.

Survey data for use on NYSDOT projects will be coordinated and reported in the New York State Plane Coordinate System (NYSPCS) of 1983 (with specified adjustment date) as established in Chapter 605 of the 1995 Laws of the State of New York amending Chapter 605 of the 1938 Laws of the State of New York. Chapter 605 of the 1938 Laws of the State of New York authorized the Department of Public Works (Predecessor of NYSDOT) as administrative agency in connection with the NYSPCS.

NYSDOT COORDINATE SYSTEMS AND DATUMS

6.4 NYSPCS ZONES

NYSPCS is made up of 4 zones: West, Central, East and Long Island.

FIGURE I. NYSPCS ZONES



For a definition of these zones refer to Chapter 605 of the 1995 Laws of the State of New York. Coordinates are specific to each zone. Coordinates can be projected from one zone to another accurately. Most Surveying, GPS, and Geographic Information System (GIS) software include projection tools to convert state plane coordinates from one zone to another. NYSDOT Projects that extend from one zone to another should use NYSPCS coordinates based only in one zone.

6.5 HORIZONTAL DATUM

An ellipsoid is a mathematically defined, regular surface (with specific dimensions) most closely approximating the shape of the earth. It is a biaxial ellipse rotated about its minor (shorter) axis. It's like a flattened sphere because the earth is in fact flattened slightly at the poles and bulges somewhat at the equator.

A geodetic datum is a mathematical model that consists of an ellipsoid and an initial point of reference. Once a datum is adopted, it provides the surface to which ground control measurements are referred. A horizontal datum forms the basis for the computations of horizontal control surveys in which the curvature of the earth is considered. The two horizontal datums normally concerned with in mapping are the North American Datum of 1927 (NAD27) and the North American Datum of 1983 (NAD83). Problems with NAD27 included measurement errors and intentional distortions. The datum was redefined and recomputed, resulting in NAD83, which is more accurate. Two of the important parameters that define a datum are the reference ellipsoid selected for the computations and the location of an initial point of reference, or origin. NAD83's reference ellipsoid is Geodetic Reference System 1980 (GRS80). GPS

NYS DOT COORDINATE SYSTEMS AND DATUMS

uses the World Geodetic System 1984 (WGS-84) reference ellipsoid (an earth-centered ellipsoid whose origin is the center of the earth's mass). The differences between WGS-84 and GRS80 are very small and for most GPS applications these ellipsoids can be considered equal (the difference is to the 9th decimal place).

Horizontal coordinates shall be reported in the North American Datum of 1983 (NAD83) as defined in NOAA Manual NOS NGS 5 "State Plane Coordinate System of 1983".

The CORS adjustment of NAD83 coordinates, available from NGS, shall be used. The most recent CORS adjustment shall be used, currently NAD83 (CORS96). The most recent EPOCH date shall be used, currently EPOCH 2002.

To assure the most current data is used, coordinates for these stations shall be obtained from the [NGS database](http://www.ngs.noaa.gov/cgi-bin/datasheet.pr1) at: <http://www.ngs.noaa.gov/cgi-bin/datasheet.pr1>

The physical reference network (the ground control stations) for the NAD83 (CORS) datum shall be any CORS station that is part of the [NYS Spatial Reference Network \(NYSNet CORS/RTN\)](#). When necessary, National CORS surrounding NYS may also be included in the control survey.

When including other CORS stations their data availability and stability should be considered.

NYS DOT COORDINATE SYSTEMS AND DATUMS

6.6 VERTICAL DATUM

A vertical datum is a surface to which elevations are referred. Elevations (Orthometric Heights) shall be reported in the North American Vertical Datum of 1988 (NAVD88). The physical reference network (the ground control stations) for NAVD88 shall include any station listed in the NGS database for which the orthometric height was determined by differential leveling techniques, adjusted to the NAVD88 datum, and has the appropriate accuracy classification for the survey. To assure the most current data is used; orthometric heights for these stations shall be obtained from the [NGS database](http://www.ngs.noaa.gov/cgi-bin/datasheet.pr1) at: <http://www.ngs.noaa.gov/cgi-bin/datasheet.pr1>

The NYSNet CORS/RTN is not directly connected to the North American Vertical Datum of 1988 (NAVD88). Depending upon required survey accuracy, the user must determine the appropriate connections to local vertical datums, including NAVD88. Possible connection methods when using the NYSNet CORS/RTN:

- 1) Use of GPS observations and a GEOID model.
- 2) Use of GPS observations, a GEOID model, and mean shift transformation to local benchmarks.
- 3) Use of GPS observations and a transformation to at least 4 local benchmarks surrounding the project area. Benchmarks must be checked for accuracy and integrity. For project areas larger than 10k or where there is significant undulation in the GEOID through the project area, a GEOID model should also be used.

The regional land surveyor shall be consulted when determining methods for connecting to NAVD88.

When working with old contract plans that are in US Customary Units you must take into account the difference in the Vertical Datums before incorporating the information into current Record Plans.

6.7 UNITS OF LENGTH

Survey distance measurements will be collected and reported in **feet (ft) or meters**, as specified in [Section 1.2](#). To convert **between feet and metric** dimensions they will be converted based on the U.S. Survey foot definition, by **using** the result of 39.37/12, which is 3.28083333333 (to no less than twelve significant figures).

6.8 COORDINATE CONVERSIONS

GPS works in an earth centered coordinate system. The projection to a state plane coordinate system is usually handled by GPS processing software. The GPS processing software will also calculate convergence angles and combined factors. Combined factor = (grid scale factor x ellipsoidal reduction factor).

Though convergence angles will differ from point to point, if the procedures outlined in this manual for establishing project control are followed, the effect of the change in convergence angle will have a minimal effect on the accuracy of the survey.

Though combined factors will differ from point to point based on distance from reference meridian or elevation, as a general rule a mean combined factor should be used for each

NYSDOT COORDINATE SYSTEMS AND DATUMS

project. This policy will usually cause no appreciable loss in accuracy and will eliminate confusion caused by multiple combined factors. However, where elevations of stations vary significantly, or for projects extending away from the reference meridian, applying more than one combined factor may be necessary to achieve required position and [azimuth](#) closure standards. If proper field procedures are followed, and the application of a meaned combined factor does not achieve azimuth and position closure standards, the regional land surveyor should be consulted on use of multiple combined factors.

NYS DOT COORDINATE SYSTEMS AND DATUMS

6.9 DISTANCE CONVERSIONS

When processing survey data from a total station traverse the combined factor must be applied to distances so that required traverse closure accuracy in the NYSPCS is achieved. The combined factor is the resulting product of the grid scale factor multiplied by the ellipsoidal reduction factor. Combined factor = (grid scale factor x ellipsoidal reduction factor).

When staking out survey points in the field using a total station for a survey on the NYSPCS the inverse of the combined factor (1/combined factor) should be applied to distances in order to convert NYSPCS grid distances back to ground distances.

6.10 DATUM TRANSFORMATIONS

There are coordinate transformation programs available to transform coordinates from one datum to another such as [CORPSCON](http://crunch.tec.army.mil/software/corpscon/corpscon.html).

<http://crunch.tec.army.mil/software/corpscon/corpscon.html>

CORPSCON incorporates NGS programs such as [NADCON](http://www.ngs.noaa.gov/TOOLS/Nadcon/Nadcon.html)

<http://www.ngs.noaa.gov/TOOLS/Nadcon/Nadcon.html>

and [VERTCON](http://www.ngs.noaa.gov/FORMS_PROCESSING/Vertcon/vertcon.html)

http://www.ngs.noaa.gov/FORMS_PROCESSING/Vertcon/vertcon.html

to compute transformations between datums. NADCON and VERTCON transformations between datums are based on a model of over 250,000 common stations. Therefore, conversions are approximate and accuracy can vary depending on location and proximity to common stations.

NADCON

The accuracy of the transformations should be viewed with some caution. At the 68 percent (1 sigma) confidence level, this method introduces approximately 0.15 meter uncertainty within the conterminous United States between NAD27 and the initial adjustment of NAD83 published in 1986 and referenced as NAD83(1986).

Transformations between NAD83 (1986) and HARNs introduce approximately 0.05 meter uncertainty.

VERTCON

The VERTCON 2.0 model was computed on May 5, 1994 using 381,833 datum difference values. A key part of the computation procedure was the development of the predictable, physical components of the differences between the NAVD 88 and the National Geodetic Vertical Datum of 1929 (NGVD 29) datums. This included models of refraction effects on geodetic leveling, and gravity and elevation influences on the new NAVD 88 datum. Tests of the predictive capability of the physical model show a 2.0 cm RMS agreement at the 381,833 data points. For this reason, the VERTCON 2.0 model can be considered accurate at the 2 cm (1 sigma) level.

NYS DOT COORDINATE SYSTEMS AND DATUMS

These programs only model shifts between datums, they are not based solely on a mathematical formula. While these transformations may be adequate for most mapping, low-accuracy surveying, or navigation applications, they are usually not accurate enough for survey control. Therefore, if the scope of a project requires tying in to a previous project on a different datum, either:

1. control stations from the previous project must be reobserved in the current survey. A minimum of 5 , well distributed control stations should be incorporated into the current survey, or
2. original observations from connected stations can be readjusted in the new datum.

6.11 DOCUMENTATION

The survey field notes and/or control report shall identify:

- 1) The coordinate system (NYSPCS), zone (EAST, CENTRAL, WEST, or LONG ISLAND), and datum (NAD83).
- 2) The date of the datum adjustment (NAD83/96).
- 3) The name and coordinates of horizontal control stations used to establish such coordinates. The NGS PID (Point Identifier).
- 4) The agency establishing those coordinates (NGS).
- 5) The combined factor, ellipsoidal reduction factor, and grid scale factor.
- 6) Units of Length.
- 7) The geoid model used.

The Licensed Land Surveyor responsible for such work shall certify on or within such documents that the survey connections to the control stations meet or exceed the minimum accuracy standards.

6.12 REFERENCES

1. Chapter 605 of the Laws of 1995 of the State of New York. Refer to this for the definition of NYSPCS zones.
2. [State Plane Coordinate System of 1983, NOAA Manual NOS NGS 5;](http://www.ngs.noaa.gov/PUBS_LIB/ManualNOSNGS5.pdf)
http://www.ngs.noaa.gov/PUBS_LIB/ManualNOSNGS5.pdf Refer to this document for definitions and computations required for working in the NYSPCS.
3. [National Imagery and Mapping Agency, Technical Report TR8350.2 "World Geodetic System 1984, Its Definition and Relationship with Local Geodetic Systems."](http://earth-info.nga.mil/GandG/publications/tr8350.2/wgs84fin.pdf)
<http://earth-info.nga.mil/GandG/publications/tr8350.2/wgs84fin.pdf>
4. [Federal Register Notice, Vol 54. No. 113, June 14, 1989 "Affirmation of Datum for Surveying and Mapping Activities."](http://www.ngs.noaa.gov/PUBS_LIB/FedRegister/FRdoc90-18809.pdf)
http://www.ngs.noaa.gov/PUBS_LIB/FedRegister/FRdoc90-18809.pdf
5. [Federal Register Notice, Vol 58. No. 120, June 24, 1993 "Affirmation of Vertical Datum for Surveying and Mapping Activities."](http://www.ngs.noaa.gov/PUBS_LIB/FedRegister/FRdoc93-14922.pdf)
http://www.ngs.noaa.gov/PUBS_LIB/FedRegister/FRdoc93-14922.pdf
6. [Federal Register Notice, Vol 55. No. 155, August 10, 1990 "Notice to Adopt Standard Method for Mathematical Horizontal Datum Transformation."](http://www.ngs.noaa.gov/PUBS_LIB/FedRegister/FRdoc90-18809.pdf)
http://www.ngs.noaa.gov/PUBS_LIB/FedRegister/FRdoc90-18809.pdf

Refer to the remaining chapters of this manual for standards and procedures consistent with working in the NYSPCS.

7. CONTROL NETWORK DENSIFICATION AND EXTENSION

CONTROL NETWORK DENSIFICATION AND EXTENSION

7.1 INTRODUCTION

The purpose of this chapter is to specify the minimum standards and describe procedures for establishing NYSDOT Geodetic Control Stations for inclusion in the [National Spatial Reference System \(NSRS\)](#).

This chapter refers exclusively to control surveys accomplished solely for the purpose of extending or densifying the existing NSRS. All geodetic control surveys performed by or for the Department shall be tied to the NSRS and reported on the NAD83 (CORS96) or subsequent adjustment and NAVD88.

The NGS defines and manages NSRS - the framework for latitude, longitude, height, scale, gravity, orientation and shoreline throughout the United States. NSRS provides the foundation for transportation, communication, defense systems, boundary and property surveys, land records systems, mapping and charting, and a multitude of scientific and engineering applications. NGS also conducts research to improve the collection, distribution, and use of spatial data.

NGS provides Federal leadership in developing standards and specifications for conducting geodetic surveys, coordinates the development and application of new surveying equipment and procedures, and conducts outreach activities including technical workshops conducted throughout the United States and an advisory program conducted with several states.

As part of the NSRS NGS maintains a network of CORS which provides GPS data files for use in tying into the NSRS. NYSDOT maintains a densification of the National CORS referred to as the NYSNet CORS. NGS also maintains a monumented network of Geodetic Control Stations, referred to as the FBN. NYSDOT maintains a densification of this FBN referred to as CBN. Together the FBN and CBN stations make up the NYS High Accuracy Reference Network (NYHARN). This is a network of "B" order or higher accuracy monumented stations. Vertical Control Stations are also included in the NSRS. In New York State, DOT is responsible for managing and maintaining the NYSNet CORS and the NYHARN.

CONTROL NETWORK DENSIFICATION AND EXTENSION

FIGURE II. NSRS in New York State

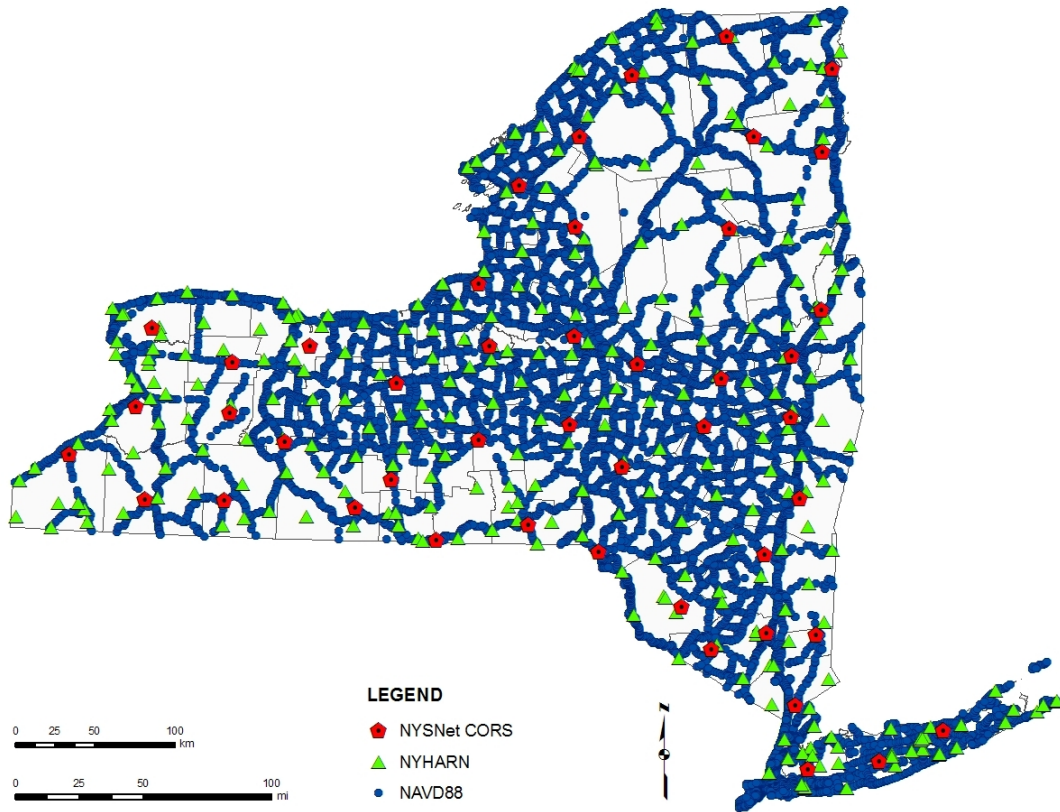

CONTROL NETWORK DENSIFICATION AND EXTENSION

7.2 MONUMENTATION

7.2.1 Horizontal Control Stations

7.2.1.1 CORS

Monumentation of NYSDOT CORS Stations shall be pre-approved by NYSDOT and should consider the [NGS CORS Site Guidelines](#).

7.2.1.2 HARN

Monumentation of NYHARN stations shall be a NGS 3-D rod, a disk set in a massive concrete structure or bedrock, or pre-existing vertical control stations of suitable stability and suitable for GPS observations.

7.2.2 Vertical Control Stations

Monumentation of vertical geodetic control stations shall be an NGS 3-D rod, or a disk set in a massive concrete structure or bedrock.

7.3 MINIMUM STANDARDS

7.3.1 Horizontal Geodetic Control Standards

CORS Stations established for NYSDOT will be coordinated with NGS for inclusion into the National CORS Network. Establishment of CORS shall be according to current [NGS specifications](#) and shall be approved by NYSDOT.

NYHARN Stations established for NYSDOT shall be "B" order or better as specified in Geometric Geodetic Accuracy Standards and Specifications for Using GPS Relative Positioning Techniques, FGCC, 1989

http://www.ngs.noaa.gov/FGCS/tech_pub/GeomGeod.pdf

7.3.2 Vertical Geodetic Control Standards

Vertical Geodetic Control Stations established for NYSDOT shall be established by Geodetic Differential Leveling per the Federal Geodetic Control Committee's (FGCC) publication "Standards and Specifications for Geodetic Control Networks" published September, 1984. Stations shall be established at an accuracy classification of 2nd Order, Class 2 or better per "FGCS Specifications and Procedures to Incorporate Electronic Digital/Bar Code Leveling Systems", version 4.0" published July 15, 1994 by FGCS

http://www.ngs.noaa.gov/FGCS/tech_pub/Fgcsvert.v40.specs.pdf

Monumentation of vertical geodetic control stations shall be an NGS 3-D rod or a disk set in a massive concrete structure or bedrock.

CONTROL NETWORK DENSIFICATION AND EXTENSION

7.4 FIELD PROCEDURES

7.4.1 Horizontal Geodetic Control Field Procedures

Field procedures for establishing CORS Stations shall be as specified by NGS.

Field Procedures for establishing HARN Stations shall be as specified by NGS and be consistent with Geometric Geodetic Accuracy Standards and Specifications for Using GPS Relative Positioning Techniques, FGCC.

http://www.ngs.noaa.gov/FGCS/tech_pub/GeomGeod.pdf

A GPS plan shall be submitted for approval prior to conducting field work.

7.4.2 Vertical Geodetic Control Field Procedures

Field Procedures for establishing Vertical Geodetic Control shall be as specified by the national geodetic survey in the NGS publication entitled "NOAA Manual NOS NGS 3 Geodetic Leveling" dated August 1981 and be consistent with "FGCS Specifications and Procedures to Incorporate Electronic Digital/Bar Code Leveling Systems", version 4.0" published July 15, 1994 by FGCS.

http://www.ngs.noaa.gov/FGCS/tech_pub/Fgcsvert.v40.specs.pdf

A leveling plan shall be submitted for approval prior to conducting field work.

7.5 DATA PROCESSING

The completed data will be submitted to NYSDOT in NGS Blue Book format as specified in FGCC document "Input Formats and Specifications of the National Geodetic Survey Data Base" dated January 1989 and reprinted May 1992.

<http://www.ngs.noaa.gov/FGCS/BlueBook/>

7.6 QUALITY CONTROL

The Licensed Land Surveyor responsible for this work shall assure that field procedures are consistent with the NGS specifications for the desired classification. All field work shall be checked for internal accuracy. All documentation shall be checked for completeness, accuracy and format.

7.7 DOCUMENTATION

Original field notes in electronic format shall be submitted to NYSDOT. Bluebook format files shall be submitted to NYSDOT for forwarding to NGS.

CONTROL NETWORK DENSIFICATION AND EXTENSION

7.8 REFERENCES

- 1) Geometric Geodetic Accuracy Standards and Specifications for Using GPS Relative Positioning Techniques, FGCC, 1989
http://www.ngs.noaa.gov/FGCS/tech_pub/GeomGeod.pdf
- 2) Federal Geodetic Control Committee's (FGCC) publication "Standards and Specifications for Geodetic Control Networks" published September, 1984
3. "NOAA Manual NOS NGS 3 Geodetic Leveling" dated August 1981
4. "FGCS Specifications and Procedures to Incorporate Electronic Digital/Bar Code Leveling Systems", version 4.0" published July 15, 1994 by FGCS
http://www.ngs.noaa.gov/FGCS/tech_pub/Fgcsvert.v40.specs.pdf
5. "Input Formats and Specifications of the National Geodetic Survey Data Base " dated January 1989 and reprinted May 1992.
<http://www.ngs.noaa.gov/FGCS/BlueBook/>

8. PRIMARY PROJECT CONTROL

PRIMARY PROJECT CONTROL

8.1 INTRODUCTION

The purpose of this chapter is to specify the minimum standards and procedures for establishing Primary Project Control on NYSDOT capital projects.

Primary Project Control may pre-exist in proximity to a project site. The Regional Land Surveyor shall be consulted prior to conducting a primary project control survey to determine whether pre-existing control shall be used.

When the term *primary project control* is used in this manual, it refers to the **azimuth pairs**, **GPS reference (base) stations**, and **bench marks** (Figure III) established in proximity to the project site, and beyond the project limits. The primary project control is used to establish secondary project control within the project area, to control the engineering and real property acquisition work required for a project. Points established under these standards and procedures are in proximity to the work limits of the project and are considered to be permanent control for the project. In this manual, *primary project control* is not intended to include densification or extension of existing geodetic control networks.

Depending upon the project needs, primary project control may or may not be needed. It is possible that the NYSNet CORS/RTN may be suitable for all the positioning needs for a project. The regional land surveyor shall be consulted to determine whether or not primary project control is needed.

FIGURE III. NYSDOT Survey Control Classifications

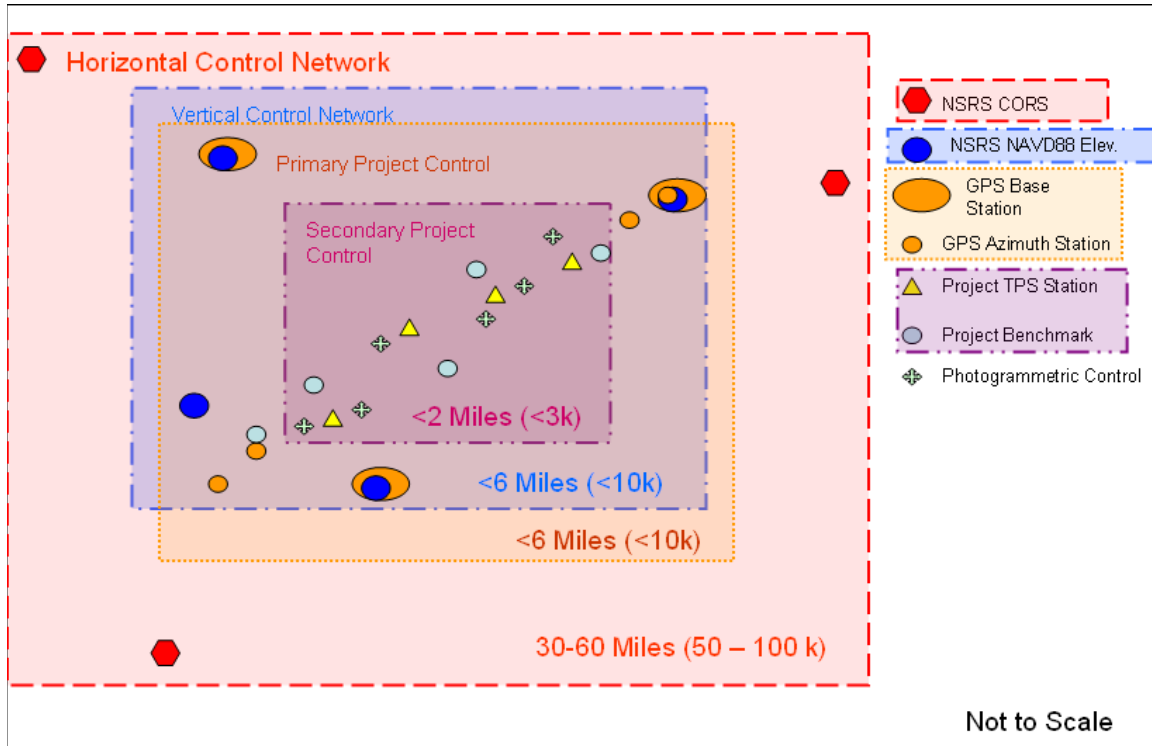

PRIMARY PROJECT CONTROL

Survey procedures may differ depending upon the project type. Network design can affect the local accuracy of these control stations. See [8.4.1.3 Network Design](#) for guidance on Network design by project type.

These guidelines are designed to ensure that a survey performed with GPS technology is repeatable, legally defensible, and referenced to the NSRS, by demonstrating the following:

1. Elimination or reduction of known and potential systematic error sources.
2. Occupational (station) and observational (baseline) redundancy to clearly demonstrate compliance with the stated accuracy.
3. Baseline processing, data adjustment and data analysis, to clearly demonstrate compliance with the stated accuracy.
4. Documented verification of the results to clearly demonstrate compliance with the stated accuracy.

GPS survey guidelines continually evolve with the advancements in equipment and techniques. Changes to these guidelines are expected as these advancements occur. The size, scope and site conditions of a project may also require variations from these guidelines. Any variations from these guidelines should be designed to meet the above criteria, and to achieve the accuracy standard of the survey as required by this document. All variations shall be discussed with the Regional Land Surveyor, and documented in the GPS Survey Report.

A network layout plan for the primary project control survey shall be submitted to the Regional Land Surveyor for approval, prior to the beginning of any field work.

PRIMARY PROJECT CONTROL

8.2 MONUMENTATION

Monumentation for primary project control should be a NGS 3-D rod, disk in massive concrete structure or bedrock, a poured in place concrete monument, or a drive-in type with expanding prongs (e.g., Berntsen FENO).

All primary project horizontal control stations shall be tied to 3 or 4 physical features, depending on the situation. Measure angles and distances, to tie objects, with a total station and record in the data collector. Observations to tie objects are normally recorded as a horizontal angle, slope distance, and zenith angle observation in the data collector. Distances can also be measured with a steel tape and entered into the data collector. The intent is for the ties to be plotted accurately and automatically in the digital graphics file with the rest of the survey information. Horizontal distances from tie objects should appear in reports, drawings, or computer files, unless otherwise noted.

Industrial Code Rule 53 of the New York State Department of Labor makes it the responsibility of the organization or firm actually setting monuments to contact the Underground Facilities Protective Organization (UFPO) in your area before beginning work. This requirement does not cover surveying per se, but specifically any mark or monument setting activity. Make reference to monument installation when calling UFPO at: (800) 962-7962 upstate; (800) 272-4480 in NYC and on Long Island.

8.3 MINIMUM STANDARDS

8.3.1 Primary Horizontal Project Control Standards

Primary Horizontal Project Control shall be established using GPS Relative Positioning Techniques and, depending upon the project requirements, may consist of:

8.3.1.1 Azimuth Pairs

Azimuth pairs consist of a pair of intervisible survey monuments, established to control a Total Station Positioning System (TPS) Survey ([Secondary Project Control](#)). The monuments in each pair shall be spaced at more than **1000 ft. (300 m)** apart in order to meet azimuth reference requirements. Azimuth Pairs shall be set at a maximum of **2 mile (3 km)** intervals throughout the project site, and suitably placed at locations to limit GPS obstructions, and to optimize their use at the project site.

All GPS surveys for primary horizontal project control **azimuth pairs** shall meet the standards of at least order C2-I as defined in *GEOMETRIC GEODETIC ACCURACY STANDARDS AND SPECIFICATIONS FOR USING GPS RELATIVE POSITIONING TECHNIQUES*, Federal Geodetic Control Committee (FGCC), August, 1989.

http://www.ngs.noaa.gov/FGCS/tech_pub/GeomGeod.pdf

PRIMARY PROJECT CONTROL

8.3.1.2 Base Stations

GPS Base stations, set within **6 miles (10 km)** of the project site, suitably placed at locations to limit obstructions, to control secondary project control surveys, photogrammetric ground control surveys, and terrain data surveys.

All GPS surveys for primary horizontal project control **base stations** shall meet the standards of at least order C1 as defined in *GEOMETRIC GEODETIC ACCURACY STANDARDS AND SPECIFICATIONS FOR USING GPS RELATIVE POSITIONING TECHNIQUES*, Federal Geodetic Control Committee (FGCC), August, 1989.

http://www.ngs.noaa.gov/FGCS/tech_pub/GeomGeod.pdf

8.3.2 Primary Vertical Project Control Standards

Primary Vertical Project Control shall be established using GPS, trigonometric or differential leveling techniques.

To qualify for adjustment, level line (differential, trigonometric or GPS) error shall not exceed $.03 \text{ ft} \sqrt{D}$ where D is the length of the level line in miles (shall not exceed $8\text{mm} \sqrt{D}$ where D is equal to the length of the level line in kilometers).

8.4 PROCEDURES

8.4.1 Primary Horizontal Project Control Procedures

8.4.1.1 Equipment

Surveyors shall employ dual frequency, full wavelength GPS receivers. No less than two (2) GPS receivers observing simultaneously shall be employed on the project control, while CORS are also included in the survey. Additional receivers could be employed on the project control to achieve increased productivity.

The antenna make and model employed on NYSDOT surveys must have been calibrated by [NGS and have a defined phase center variability model for use in processing](#). Antennae types shall be accounted for in the GPS processing so that the correct phase center offsets are applied to determine the [Antennae Reference Point \(ARP\)](#).

8.4.1.2 Techniques

Static GPS observation techniques shall be used.

Post-processing of simultaneous field observations shall be used.

PRIMARY PROJECT CONTROL

8.4.1.3 Network Design

GPS surveys for Primary Horizontal Project Control should be configured as geometrically closed networks of redundant vectors. All primary project control stations shall have two independent occupations. All primary project control azimuth pairs, and any other relatively short lines, must have two independent baseline vectors. Redundant baseline vectors are accomplished only by completely independent occupations of stations. Independent occupations require that the tripod or stand be reset and replumbed between sessions. So-called spaghetti, radial, or traverse survey schemes are not to be used for establishing primary project control on NYSDOT capital projects.

Redundancy in network design is achieved by connecting each network station with at least two independent baselines, including all stations in a series of interconnecting, closed loops, and repeating baseline vectors.

Closing the network geometrically means designing your network using good, closed geometry. A GPS or terrestrial network consists of a series of observations (baseline vectors) between network points. These baselines create closed, geometric figures such as triangles.

Structure your network design such that closed figures (loops) are created from baselines observed in two or more sessions. Each loop shall have at least one baseline in common with another loop. All new stations shall be included in a loop of not more than 10 baselines and a loop length of less than **60 miles (100 km)**.

Only independent baselines should be processed and incorporated into loop closures and included in the network adjustment. The use of independent baselines ensures that all data is used only once. Dependent data can introduce a bias into a data set and give erroneous results. If a GPS session uses 2 GPS receivers on project control and 2 CORS (a total of 4 receivers), the raw data produces 6 potential baselines :

$$\begin{aligned}\# \text{ of Baselines} &= N(N-1)/2 \\ \# \text{ of Independent Baselines} &= N-1 \\ N &= \# \text{ of receivers}\end{aligned}$$

Therefore only three independent baselines are created using a total of 4 receivers. The remaining three, observed at the same time, would be dependent, connected by common geometry and errors. Independent baselines must not form a closed figure. The surveyor decides which three baselines to process in order to achieve the network.

Azimuth pair baselines must be repeated to provide redundant observations in order to isolate and identify errors, and to provide network quality control checks, thereby increasing confidence in the results.

PRIMARY PROJECT CONTROL

Three [Continuously Operating Reference Stations \(CORS\)](#) that are included in the [NYS Spatial Reference Network \(NYSNet\)](#) shall be incorporated into the network design. Where possible, the three CORS shall surround the project site and be located in three different quadrants. In areas of the state where this is not possible, a [National CORS](#) or a NYHARN station may be included in the network in order to achieve network geometry surrounding the project site and located in three quadrants. Use of [cooperative CORS](#) that are not included in NYSNet should be avoided.

When planning network connections to CORS, the [data availability and time series plots](#) should be considered. When making connections to the NYHARN, the network accuracy of the station should be considered in the network adjustment.

The antenna type at the CORS station shall be identified in the processing. NGS phase center offset models shall be used to determine the offset from the ARP (Antenna Reference Point) to the antennae phase center. The coordinate for the ARP of the CORS station shall be used in processing.

Network statistics for Azimuth pair stations shall meet the requirements for order C2-I; network statistics for base stations shall meet the requirements for order C1, as defined in *GEOMETRIC GEODETIC ACCURACY STANDARDS AND SPECIFICATIONS FOR USING GPS RELATIVE POSITIONING TECHNIQUES*, Federal Geodetic Control Subcommittee, August, 1989. http://www.ngs.noaa.gov/FGCS/tech_pub/GeomGeod.pdf

Typical Network diagrams depend upon project type. For projects that will require Survey Terrain Data Collection using Total Station Positioning System (TPS) techniques only, the network diagram shown in Fig. IV is typical. This network establishes Azimuth Pair Control Stations only. If it is determined best to establish primary vertical control using GPS techniques, refer to [Fig. VII](#) in [Section 8.4.2.3](#).

PRIMARY PROJECT CONTROL

FIGURE IV. Horizontal Primary Control Survey To Azimuth Pair Stations

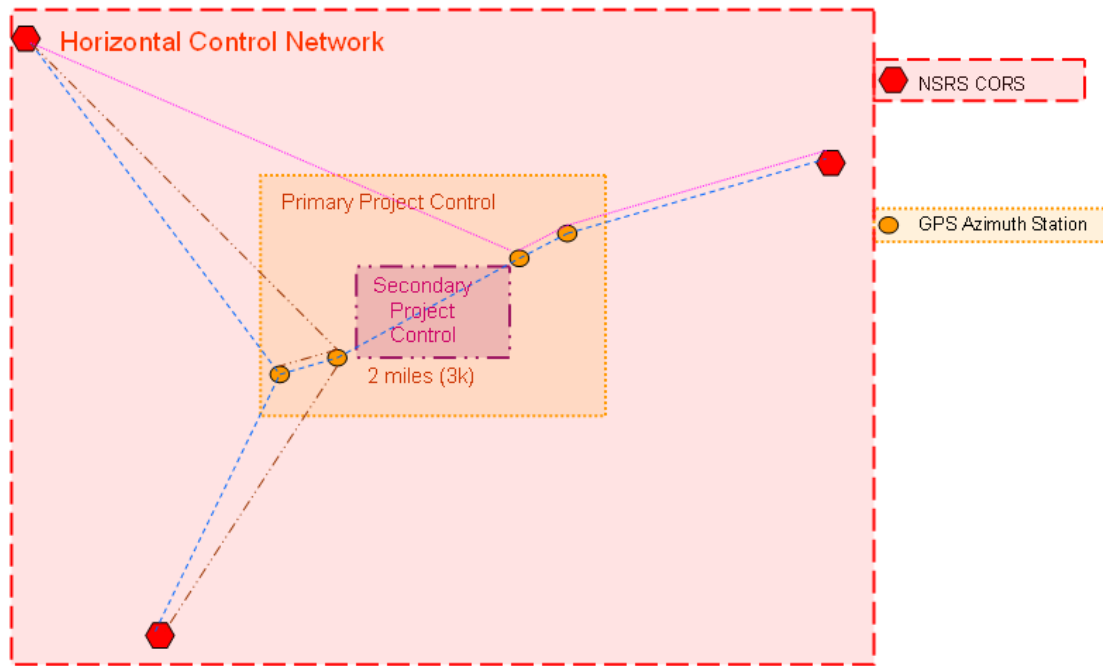

Not to Scale

Line symbology indicates independent GPS baselines by session using 2 GPS receivers on project control, and 2 CORS (total of 4 receivers per session).

PRIMARY PROJECT CONTROL

GPS Base Stations should be established for projects that will require a photogrammetric control survey by Fast Static GPS or Local RTK (LRTK), or for projects that will make use of GPS techniques for terrain data collection, construction stakeout, or automated machine guidance by Fast Static GPS or Local RTK (LRTK) methods.

Base Stations should be established in a network separate from the Azimuth Pairs as shown in Figure V. Base Stations shall be within **6 miles (10 km)** of the project site and should be about half the project length away from project centerline, surrounding the project site, in at least 3 quadrants. A fourth Base Station can be added to better surround the project site. For larger projects establish additional Base Stations to limit the distance to photogrammetric control targets or **secondary project control** points to no more than **6 miles (10 km)**. Azimuth Pair Stations should then be established as shown in Figure VI. Field work for these networks can be accomplished at the same time but the networks should be processed in this order.

If vertical control is required, Base Stations could be NSRS bench marks or eccentric stations tied to NSRS bench marks. Location of photogrammetric control targets using GPS should be configured as shown in [Section 10.3.1.1](#) .

If Network RTK (NRTK) is going to be used to conduct the photogrammetric control survey, there may be no need to establish local base stations. However, there may still be a need to tie to local NAVD88 Elevations surrounding the project site.

If NRTK is going to be used to establish Azimuth Pairs on a project, they may be surveyed as shown in figure IV.

PRIMARY PROJECT CONTROL

FIGURE V. Horizontal Primary Control Survey To Base Stations

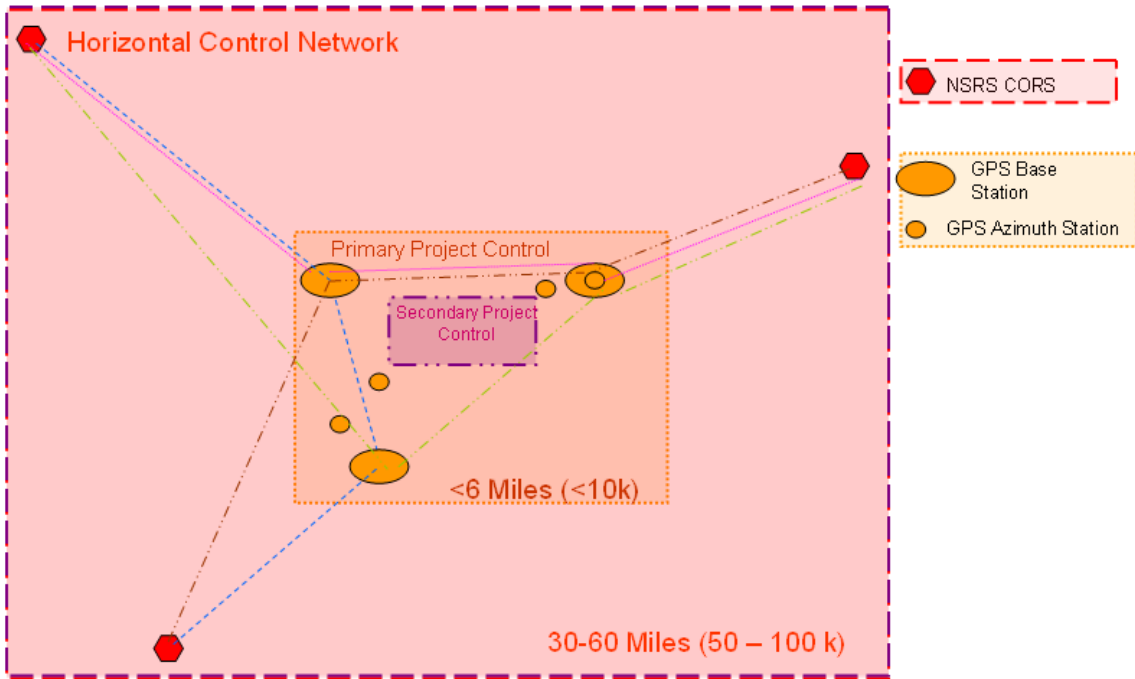

Line symbology indicates independent GPS baselines by session using 2 GPS receivers on the project control and 2 CORS (a total of 4 receivers per session).

PRIMARY PROJECT CONTROL

For projects that establish Base Stations, the Base Stations should be used as fixed control to establish Azimuth Pair Stations. The vectors used for the adjustment between the Base Stations (see Figure V) should be used for loop closures and adjustment of the Azimuth Control Stations. Figure VI is an example of the network design from the Base Stations to the Azimuth Stations for a project where two sets of Azimuth Stations were required. If vertical control is required, Base Stations could be NSRS bench marks or eccentric stations tied to NSRS bench marks.

FIGURE VI. Horizontal Primary Control Survey From Base Stations to Azimuth Pair Stations

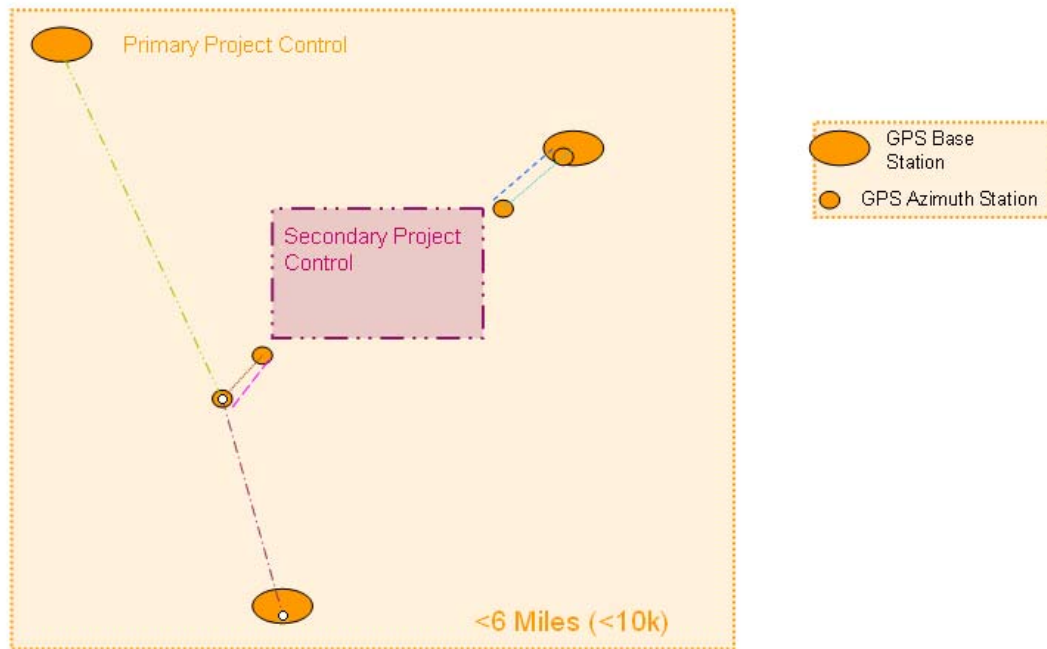

Not to Scale

Line symbology indicates independent GPS baselines by session using 2 receivers on the project.

PRIMARY PROJECT CONTROL

A GPS Plan for the Primary Project Control shall be submitted to the Regional Land Surveyor for review and approval, prior to beginning of any fieldwork. The GPS Plan shall include:

1. A network diagram showing independent baselines by sessions (indicate sessions by either (a) color, (b) line symbology, or (c) label/number the lines).
2. A summary of network statistics (see Section 8.7.2.1).
3. A session schedule.

Planning

Proper planning and network design shall be used in GPS surveys for primary project control.

Satellite almanacs used for observation planning shall be no more than 30 days old.

Stations should be situated in locations that minimize obstructions. In general, a clear view of the sky above 20 degrees is desired.

Field reconnaissance and pre-mission observation planning will be accomplished for all surveys. Sky visibility diagrams will be made for all stations. Diagrams will show magnetic azimuth and elevation angle to all obstructions above 15° to whole degrees. Obstruction data will be entered into a GPS observation planning program and multi-receiver sessions will be analyzed for acceptable observing times. Magnetic Declination should be compensated for in the planning program obstruction diagrams. Analysis should consider the number of available satellites and PDOP.

At least four **healthy** satellites shall be observed in common at all simultaneously occupied stations.

The PDOP should not exceed 6 during any GPS survey observations.

Static GPS observations for primary project control, using dual frequency receivers, the minimum observation session length shall be 30 minutes. For lines over 12 miles (20 km) add 2 minutes per mile (1 minute per 1 km) of GPS baseline length beyond 12 miles (20 km). A GPS baseline of **12 miles (20 km)** in length would require a minimum observation of 30 minutes. A GPS baseline of **25 miles (40 km)** in length would require a minimum observation of 50 minutes. Final choice of observation session lengths shall also consider site obstructions, predicted PDOP, number of satellites available, network configuration, and manufacturer guidelines.

Baseline length		Minimum Observation
<10 miles	<20 km	30 minutes
10-25 miles	20-40 km	45 minutes
25-30 miles	40-50 km	1 hour
30-50 miles	50-80 km	90 minutes

PRIMARY PROJECT CONTROL

Field Observation

GPS antennas should be set up over the points using fixed-height antenna tripods.

GPS observations will be collected at a minimum of 15 second data epochs. The tracking elevation mask angle should be 10°.

Vehicles should be parked away from or below the GPS antenna to minimize the chances of causing multipath signals.

Great care shall be taken in measuring and recording antenna heights. When using standard tripods, the antenna slope-height will be measured multiple times (per manufacturer's directions) and the average recorded.

8.4.2 Primary Vertical Project Control Procedures

Primary Vertical Project Control shall be established using GPS, trigonometric or differential leveling techniques.

Level runs shall begin and end on NSRS NAVD88 bench marks of first or second order accuracy classification. When first or second order bench marks are unavailable, the Regional Land Surveyor should be consulted for guidance. To confirm the integrity of the NSRS bench marks used, the leveling shall start on one NSRS bench mark and close on another NSRS bench mark. If leveling to a second NSRS bench mark is not practical or economical the Regional Land Surveyor should be consulted for guidance. When using GPS techniques, at least 4 well distributed (in four quadrants surrounding the project site) NSRS NAVD88 bench marks shall be incorporated into the GPS network.

When bench marks need to be established on the project site the bench marks should be incorporated into a primary differential level-run.

8.4.2.1 Differential Leveling

Digital levels with bar code rods shall be used. Use a sectional composite or invar bar-code staff.

Expend reasonable effort when balancing backsights and foresights. Use subsequent set-ups to make up for deficiencies in balancing. Difference in forward and backward sight lengths should never exceed **30 ft. (10 meters) per setup or 30 ft. (10 meters) per section**. Maximum sight length should not exceed **230 ft. (70 meters)** Minimum ground clearance of line of sight should be **1.6 ft. (0.5 meters)**.

To qualify for adjustment, level line error, expressed in **feet**, shall not exceed $.03 \text{ ft} \sqrt{D}$ where D is the length of the level line in miles (shall not exceed $8 \text{ mm} \sqrt{D}$ where D is equal to the length of the level line in kilometers).

8.4.2.2 Trigonometric Leveling

PRIMARY PROJECT CONTROL

The total station used for trigonometric leveling should be a one-second least-reading instrument. The total station used should have a minimum DIN accuracy of two seconds (angle) and 2mm +2ppm (distance).

Account for the correct prism offset in all distance measurements.

Always use a target device with a retro-flector prism. The reflector alone does not make an adequate vertical target. The target/reflectors shall be tripod mounted.

Limit sight distances to about **1000 ft. (300 meters)** to minimize the impact of small pointing errors. Longer sight distances may require additional pointings, resulting in a larger sample from which to derive a mean vertical angle.

Take great care in measuring the heights of instruments and targets for each set-up. Make redundant measurements to eliminate the chances of blunders. Make and record measurements at both the beginning and end of each occupation to check for settling, slipping, or misreading. When instruments and targets are exchanged on a tribrach, the HI or HT should be measured again. Never assume that they are the same or that the tripod hasn't deflected differently.

Make reciprocal observations (observations from each end of a line) on all observed lines. Observe each zenith angle with at least two D&R sets. The maximum spread of the sum of the direct and reverse zenith angles of a single set (one D&R) should be within 10 seconds. Keep re-observing rejected sets until two sets meet this tolerance.

The term *reciprocal observations* actually denotes zenith angles measured simultaneously from each end of a line. However, this procedure is rarely practical for highway surveying. In this case, zenith angle observations from each end of a line shall be separated by only a minimum amount of time in order to minimize any difference in the atmospheric conditions between stations during the observations. There are instances in which the atmospheric conditions are nearly identical during the times the zenith angles are observed at each end of the line. In these cases the effects of curvature and refraction on the zenith angle observations cancel out. However, there are other instances in which atmospheric conditions change significantly between the occupation of one point and the next. For best results in these instances repeat all observations.

Reciprocal observations correct distances and zenith angles for the effects of earth curvature and refraction. Automatic curvature and refraction corrections, applied in the instrument settings, usually apply corrections to horizontal distances and vertical changes only and do not affect the slope distances and zenith angles that are collected as part of a reciprocal observation. Therefore, automatic curvature and refraction corrections set at the instrument will have no effect on the reciprocal observation. When a line is observed from only one end, curvature and refraction corrections for determining vertical differences should be applied during processing.

Always try to occupy the known (initial and final) bench marks and all new bench marks in a trigonometric level run. Reciprocal observations cannot be made to and from a point that is not occupied. If a bench mark cannot be occupied, set up the total station

PRIMARY PROJECT CONTROL

within **70 ft. (20 meters)** of it and observe (in direct and reverse) the foresight vertical difference only. The very short distance will minimize the atmospheric effects.

PRIMARY PROJECT CONTROL

8.4.2.3 GPS Leveling

FIGURE VII. Network Diagram Incorporating Bench Marks to Establish Vertical Control on Project Site.

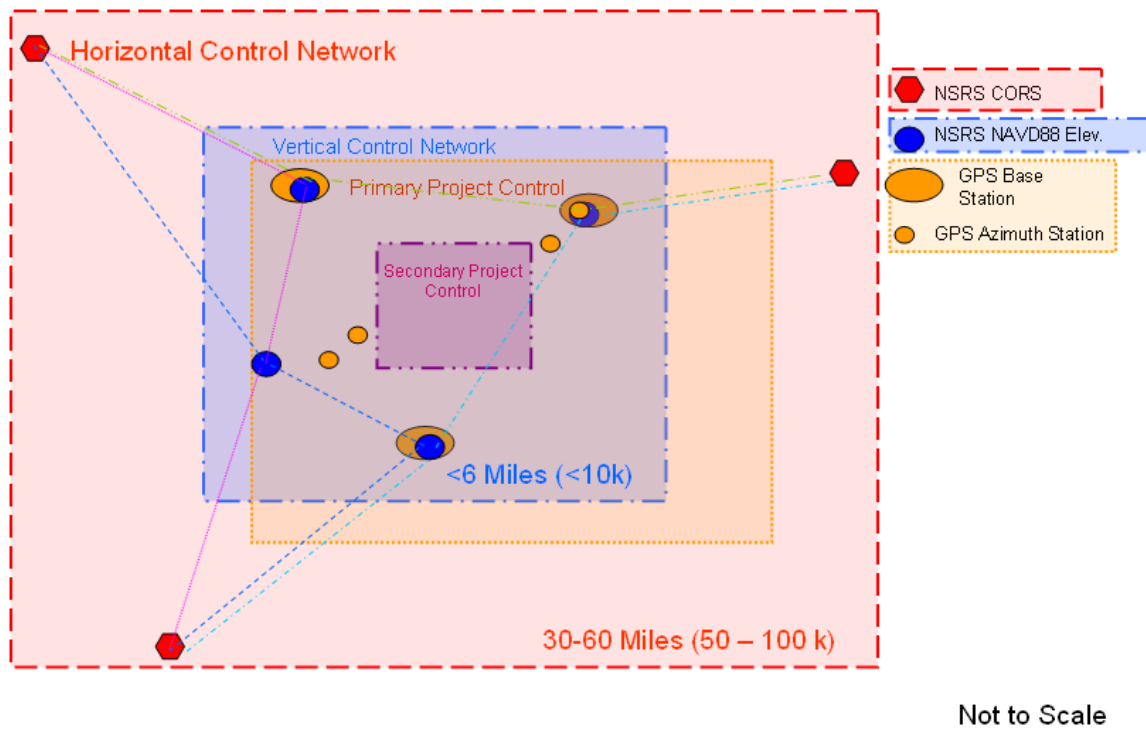

Surround project site with a minimum of 4 well distributed NSRS bench marks within **6 miles (10 km)** of the project site. NSRS bench marks should be distributed in all four quadrants of the network. Any NSRS Vertical Control Station of 2nd-Order or better, within **3 miles (5 km)** of the project site should be incorporated into the network. If a large change in elevation exists through the project site, bench marks should be occupied at the base and summit of these elevation changes. Bench marks should have an NSRS vertical accuracy classification of 2nd order or better. Incorporate NSRS bench marks into the Primary Horizontal Project Control Survey. Whenever possible bench marks should be directly observed in the GPS network, however eccentric points can be used if necessary. Level connections to eccentric points shall follow primary vertical project control standards and procedures and field notes shall be included in the GPS control report. Independently occupy 100% of NSRS bench marks and vertical control stations. Occupations should be repeated 27-33 hours after initial observations.

Follow [Primary Horizontal Project Control](#) recommended procedures for planning and field observations. VDOP should be considered in session planning for a vertical control GPS survey. VDOP should be less than 4.

These Vertical Control Stations could also be used as Base Stations for LRTK and for establishing Azimuth Pair Stations. For a Network Diagram to establish Azimuth Pair Stations from Base Stations, see [Figure VI](#).

PRIMARY PROJECT CONTROL

8.5 DATA PROCESSING

8.5.1 Horizontal

GPS survey observations may be post-processed with the broadcast ephemeris or a [precise ephemeris \(rapid or final\)](#).

Process baselines using a default elevation mask of 15 degrees. Alter elevation mask when necessary.

The quality of baselines shall be checked according to the software manufacturer's guidelines. All baseline solution types should be fixed. A fixed solution is obtained when the processor is able to find a set of integer values for the ambiguity terms that are significantly better than all other possibilities.

The RMS (root mean square) should be less than **0.05 ft. (15 mm)**.

Loop closures should be analyzed.

For Base Stations, in any component (X,Y,Z), "maximum" misclosure, not to exceed **0.8 ft. (25 cm)**. In any component (X,Y,Z), "maximum" misclosure, in terms of loop length, not to exceed 12.5 ppm. In any component (X,Y,Z), "average" misclosure, in terms of loop length, not to exceed 8 ppm. Repeat Baselines should be analyzed. In any component (X,Y,Z), "maximum" not to exceed 10 ppm.

For Azimuth Pairs, in any component (X,Y,Z), "maximum" misclosure, not to exceed **1.0 ft. (30 cm)**. In any component (X,Y,Z), "maximum" misclosure, in terms of loop length, not to exceed 25 ppm. In any component (X,Y,Z), "average" misclosure, in terms of loop length, not to exceed 16 ppm. Repeat Baselines should be analyzed. In any component (X,Y,Z), "maximum" not to exceed 20 ppm.

Only independent baselines should be incorporated into network adjustment.

A minimal constrained adjustment should be performed holding one NSRS station fixed in X,Y, and Ellipsoid Height. Adjustment residuals shall be analyzed for outliers. Once internal network accuracy is proven, a fully constrained adjustment shall be performed. Adjustment residuals shall be analyzed. Outliers, if any, shall be identified, and coordinate differences shall be reported to the Regional Land Surveyor.

Expected setup errors shall be accounted for in the least squares adjustment program. Refer to [Geometric Geodetic Accuracy Standards and Specifications for Using GPS Relative Positioning Techniques, FGCC, 1989](#), Appendix D, "Expected Minimum/Maximum Antenna Setup Errors". For primary project control, an expected setup error of **0.01 ft (0.3 cm)** should be used.

Careful analysis of the minimally-constrained and fully-constrained least squares adjustments is the key to completing a project which meets its intended objectives. The following statistics shall be evaluated for each adjustment performed on a given project:

PRIMARY PROJECT CONTROL

The network variance of unit weight (variance factor) and degrees of freedom, for all variance groups, shall be evaluated. A variance factor of less than 1.5 and approaching 1.0 is considered a conservative statistic for geodetic control surveying. High variance factors may indicate blunders in the network; in this case the baseline solutions should be analyzed.

Using unusually large scalars (above 5) of error estimates for resolving outliers is not an acceptable method of passing the statistical tests. This usually indicates blunders in the network and should only be used to analyze outliers.

The RMS, minimum and maximum values, and the standard deviation of the absolute observation residuals should be equal to or better than the desired Accuracy. The sign of residuals at a particular point or network loop may indicate an undetected systematic error or blunder in the observations which are being smeared across that portion of the network. Any common trends in observation residuals are cause for further examination.

The standardized residuals, computed from the absolute residuals divided by their respective propagated standard error, shall be compared against the Chi-square test and Tau Criterion. Standardized residuals exceeding the Tau value should be further investigated as possible outliers. Failure to pass the Chi-square test is an indication that some or all of the a-priori errors have been improperly modeled. These tests are also highly influenced by external network constraints. It is not uncommon for good-quality networks to fail Chi-square and isolated residuals exceeding the Tau Criterion are not necessarily cause to reject the adjustment. These are strict statistical tests which should be used as tools to arrive at a final network adjustment meeting the objectives of the project.

Any significant changes between the statistics from the minimally-constrained adjustment and the fully-constrained adjustment should be investigated.

Posteriori errors shall be computed at the 95 percent (2 sigma) confidence level for the adjusted station coordinates and for the relative positions for all adjacent station pairs. Error ellipses provide a useful evaluation of the station confidence. Nearly circular and uniformly small error ellipses are an indication of a well- conditioned network. Irregularly shaped or unusually large error ellipse indicate problems with the satellite constellation used, gross errors or a weakness in the network design.

Apparent position shifts shall be computed between those obtained from the minimally-constrained adjustment and known values at the external network control. This is used as a check for systematic errors prior to computing any appropriate orientation parameters for rotation and scale and assigning provisional accuracy classification(s) for the project.

Error ellipse computed from random error propagation from a least squares adjustment, where the survey measurements have the correct weights and where the horizontal and vertical datum values are weighted using one-sigma network accuracies of the existing control, are used to evaluate the accuracy of a project. Relative error ellipse values are used to compute error circle radii for Local Accuracy classification. The evaluation shall be made from each point to all adjacent points regardless of the direct connections in the

PRIMARY PROJECT CONTROL

network. Point error ellipses are used to compute error circle radii for Network Accuracy classification.

After a satisfactory standard deviation of unit weight is achieved using realistic a-priori error estimates, a fully constrained adjustment can be performed.

The fully constrained adjustment fixes the coordinates of the known NSRS control stations, thereby adjusting the network to the datum of the control stations. A consistent control reference network (NSRS) shall be used for the constrained adjustment.

8.5.2 Vertical

8.5.2.1 Differential Leveling

Differential level lines should be adjusted proportionally, according to the number of turns between bench marks.

8.5.2.2 Trigonometric Leveling

Processing software used to reduce trigonometric leveling notes shall mean the change in elevation, forward and backward along the traverse legs, while accounting for the target heights at each observation.

Trigonometric level runs should be adjusted by apportioning the errors according to the distances of the legs.

8.5.2.3 GPS Leveling

Follow the same procedures as in [Section 8.5.1 Horizontal](#), including the following requirements:

Use fixed height tripods for all observations.

Minimum observation session length of 30 minutes for baselines from bench marks to project control.

Use a [precise ephemeris](#).

Fixed baseline solutions are required on all baselines.

RMS of processed baselines should be less than **0.05 ft. (1.5 cm)**.

The Processed GPS Baselines should be checked for quality according to the software manufacturer guidelines. Repeat baselines shall be checked for misclosure. In any component (X,Y,Z), "maximum" not to exceed 20 ppm. The ellipsoid height difference of all repeat baselines shall be **0.07 ft (2 cm)** or less.

Loop closures should be checked for misclosure. In any component (X,Y,Z), "maximum" misclosure, not to exceed **1 ft (30 cm)** In any component (X,Y,Z), "maximum"

PRIMARY PROJECT CONTROL

misclosure, in terms of loop length, not to exceed 25 ppm. In any component (X,Y,Z), "average" misclosure, in terms of loop length, not to exceed 16 ppm.

Perform a minimally constrained adjustment. Constrain one latitude, one longitude and one orthometric height value. Using the results from the constrained adjustment detect and remove all outliers. These two steps shall be repeated until all outliers are removed.

Compute differences between the set of orthometric heights from the minimally constrained adjustment using the latest geoid model and the published NAVD88 bench marks.

PRIMARY PROJECT CONTROL

Determine which bench marks have valid NAVD88 height values. Differences between valid bench marks need to agree within **0.07 ft.(2 cm)**.

Perform a fully constrained adjustment fixing one latitude and one longitude and all valid NAVD88 height values. At least three bench marks shall be held fixed in a fully constrained adjustment.

After a satisfactory standard deviation of unit weight is achieved using realistic a-priori error estimates, a fully constrained adjustment can be performed.

The fully constrained adjustment fixes the coordinates of the known NSRS control stations, thereby adjusting the network to the datum of the control stations. A consistent control reference network (NSRS) shall be used for the constrained adjustment.

8.6 QUALITY CONTROL

The licensed land surveyor in charge of the survey shall be responsible for the integrity and quality control of all survey data produced.

8.7 REPORTING

8.7.1 Field Notes

8.7.1.1 Horizontal

Raw data files in the manufacturer's format, along with data files in RINEX format shall be submitted for primary horizontal control surveys in digital format. Also, baseline components in NGS g-file format shall be submitted.

8.7.1.2 Vertical

Raw Data files and processed files shall be submitted for primary vertical project control surveys.

8.7.2 Survey Reports

The primary project control is used to establish secondary project control within the project area, to control the engineering and real property acquisition work required for a project. The surveyor can use the survey report to demonstrate and document to the customer the integrity of the control survey. It can also be used to guide future users of the primary project control.

Use page separators with labeled tabs, and/or an electronic table of contents, to separate each section of the report for easy referencing.

PRIMARY PROJECT CONTROL

8.7.2.1 Horizontal (GPS Survey Report)

Reporting of Primary Horizontal Project Control should include and progress as follows:

Table of Contents, Introduction, Personnel (field and office, job titles and job function), licensed land surveyor's certification, equipment calibration records and reports,

Project site location map (showing the project location and the established primary control monuments).

Project Narrative stating goals of project, standards to be achieved, NSRS monuments/bench marks used, monuments/bench marks established, coordinate system/datum/zone, geoid model, equipment and software, etc. Describe the procedures used. Comments/Recommendations

Network Diagram showing network connections, independent baselines/vectors by session, session lengths. (should evolve from the initial GPS Plan)

Summary of network statistics: (should evolve from the initial GPS Plan)

- Observing sessions (total number)

- Receivers observing simultaneously (total number)

- Total Number of Stations

- Number of new stations

- Station occupations

 - Single occupations (no redundancy)

 - Two or more occupations (number/percent)

 - Three or more occupations (number/percent)

- Baselines determined

 - All (trivial and nontrivial)

 - Independent (nontrivial)

- Repeat baselines (N-S/E-W/percent of non trivial)

- Loop closure analyses

 - Valid loops formed? /Number of stations not included in a loop

 - Loops containing baselines from (2 or more/3 or more) sessions.

 - Loops formed

- Geometric relative position classification (based on FGCC specs)

- Observation schedule

 - Maximum PDOP during session

 - Minimum number of satellites during session

- NGS Data Sheets for NSRS Stations ([NGS datasheet](#) format) (Include [CORS Coordinate Sheets](#) for National CORS)

- Control Data Sheets for Primary Project Control

PRIMARY PROJECT CONTROL

GPS Obstruction diagram for primary project control stations

Summary of baseline statistics showing quality of baselines

Solution Type

Reference Variance

Ratio

Summary of Loop Misclosures

Summary of Minimally Constrained Adjustment, network reference factor, degrees of freedom, detection and analysis of outliers. Report of coordinate differences, in NYSPC, between published and adjusted coordinates.

Summary of Fully Constrained Adjustment showing values of constrained coordinates and heights, and network reference factor. Relative error ellipse values, largest relative error ellipse value for stations established by the survey. Point error ellipse values, largest point error ellipse value.

Adjusted Coordinates reported in NYSPCS, shown to four decimal places, ellipsoid heights shown to the nearest **hundredth of a foot (millimeter)** and orthometric heights shown to the nearest **hundredth of a foot.(millimeter)** Accuracy statement for the survey, per FGCC Specifications. Combined Factor, Grid Scale Factor, and Ellipsoidal Reduction Factor.

8.7.2.2 Vertical

Differential and Trigonometric Leveling (Survey Report)

Reporting of Primary Vertical Project Control should include and progress as follows:

Table of Contents, Introduction, Personnel (field and office, job titles and job function), licensed land surveyor's certification, equipment calibration records and reports,

Project site location map (showing the project location and the established primary control bench marks).

Project Narrative stating: goals of project, standards to be achieved, Primary bench marks used, secondary bench marks established, datum references, equipment and software, etc. Describe the procedures used. Comments/Recommendations.

Description of the procedures used.

A summary Table showing the Summary of misclosures, including:

From/To

Benchrun Length (**Miles**)(**Km**)

of turning points

Record starting elevation

PRIMARY PROJECT CONTROL

Record ending elevation

Calculated ending elevation

Calculated misclosure

Allowable Misclosure based upon $.03 \text{ ft} \sqrt{D}$ where D is the length of the level line in miles ($8\text{mm} \sqrt{D}$ where D is equal to the length of the level line in kilometers).

PRIMARY PROJECT CONTROL

Network Diagram showing network connections.

Control Data Sheets for NSRS Bench marks

Control Data Sheets for the primary project control bench marks established (elevations shown to the nearest **hundredth of a foot**) (**elevations shown to the nearest millimeter**)

Summary of adjustment method and statistics

Adjusted elevations reported in NAVD 88 shown to nearest **hundredth of a foot, (millimeter)** and accuracy statement for the survey (per FGCC Specifications).

Vertical control map (based on a suitable scaled plan, e.g. 1:6000, showing the location of all secondary project control bench marks, relative to named cross streets and other prominent features).

GPS Leveling (GPS Survey Report)

[See Section 8.7.2.1](#)

8.8 REFERENCES

1. Geometric Geodetic Accuracy Standards and Specifications for Using GPS Relative Positioning Techniques, FGCC, 1989
http://www.ngs.noaa.gov/FGCS/tech_pub/GeomGeod.pdf
2. Federal Geodetic Control Committee's (FGCC) publication "Standards and Specifications for Geodetic Control Networks" published September, 1984
3. "NOAA Manual NOS NGS 3 Geodetic Leveling" dated August 1981
4. "FGCS Specifications and Procedures to Incorporate Electronic Digital/Bar Code Leveling Systems", version 4.0" published July 15, 1994 by FGCS
http://www.ngs.noaa.gov/FGCS/tech_pub/Fgcsvert.v40.specs.pdf

9. SECONDARY PROJECT CONTROL

SECONDARY PROJECT CONTROL

9.1 INTRODUCTION

The purpose of this chapter is to specify the minimum standards and describe procedures for establishing Secondary Project Control on NYSDOT capital projects.

Secondary Project Control may pre-exist at a project site. The Regional Land Surveyor shall be consulted prior to conducting a secondary project control survey to determine whether pre-existing control shall be used. It may be necessary to verify the integrity of the pre-existing control, or to supplement the pre-existing control if stations are missing or obstructed.

When the term *secondary project control* is used in this manual it refers to the control traverses, baselines and level lines occurring through the project site. The purpose is to control the engineering and real property acquisition work required for a project. Points established under these standards and procedures are generally within the work limits of the project and are assumed to be expendable but recoverable.

Secondary control traverses, level runs, and GPS baselines should begin and end on different primary control stations, for the purpose of forming independent loops or sections, to verify the accuracy of the survey. All secondary control points should be established by the use of closed traverses, level lines or GPS loops.

Secondary Project Control shall be set on all projects that require the eventual setting of proposed ROW monumentation or the stake out of proposed highway alignments during construction.

Depending upon the project needs, secondary project control may or may not be needed. It is possible that the NYSNet CORS/RTN may be suitable for all the positioning needs for a project. The regional land surveyor shall be consulted to determine whether or not primary project control is needed.

A control network layout plan for the secondary project control survey shall be submitted to the Regional Land Surveyor for approval, prior to the beginning of any field work.

SECONDARY PROJECT CONTROL

FIGURE VIII. NYSDOT SECONDARY PROJECT CONTROL

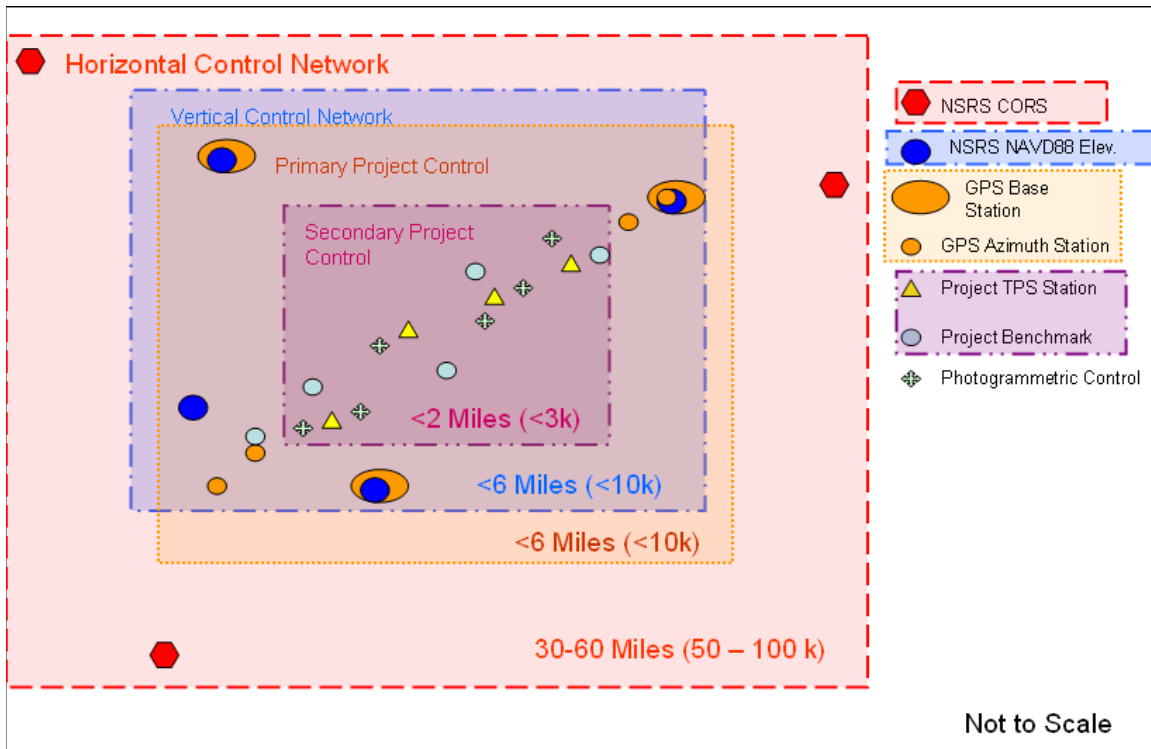

9.2 MONUMENTATION

Pursuant to 16 NYCRR 753 Protection of Underground Facilities, prior to nonemergency excavation, subsurface exploration of any kind, or installation below existing grade including, but not limited to; digging, auguring, excavation, or driving of rods below surface, the One-Call notification system shall be notified of the date and location of the proposed work. One-Call notification system shall be notified a minimum of 2 days and a maximum of 10 days, not including the date of the call, prior to work. Consult the Dig Safely website at: <http://www.digsafelyny.com/> for work in both upstate and New York City - Long Island areas. Dig Safely can also be reached at 1-800-962-7962.

9.2.1 Baseline Stations

Monumentation for secondary project control baseline stations shall usually be a No. 5 rebar with cap. Nails, chiseled marks, railroad spikes, etc. may be used if conditions prohibit the use of a No.5 rebar. Baseline Stations are assumed to be expendable but recoverable. Normally, survey baseline station intervals should be about **1000 ft. (300 meters)**, and shall be inter-visible.

SECONDARY PROJECT CONTROL

All secondary project control stations shall be tied to specifically identified points on 3 or 4 physical features, depending on the situation. Measure angles and distances to tie objects with a total station and record in the data collector. Observations to tie objects are normally recorded as a horizontal angle, slope distance, and zenith angle observation in the data collector. Distances can also be measured with a steel tape and entered into the data collector. The intent is for the ties to be plotted accurately and automatically in the digital graphics file with the rest of the survey information. Once in the basemapping, the graphics could be copied to the tie cell for placement in the contract plans and ROW. The graphics could also be copied to an image and placed on the control data sheets for inclusion in the secondary project control report. Horizontal distances from point to tie should appear in reports, drawings, etc., unless otherwise noted.

9.2.2 Bench Marks

Monumentation of secondary project control bench marks should consider stability of vertical position. Place bench marks near the anticipated limits of a contract and set at intervals of approximately **1000 ft. (300 meters)** throughout a project. When possible, place them in consideration of proposed construction limits and the anticipated/future needs of an Engineer in Charge (EIC) of the proposed project.

9.3 MINIMUM STANDARDS

9.3.1 Secondary Horizontal Project Control Standards

Secondary horizontal project control shall be established using GPS or TPS techniques to establish survey baselines in support of surveying operations on the project site.

9.3.1.1 GPS Techniques

All GPS surveys for secondary horizontal project control shall meet the standards of at least order C2-II as defined in *Geometric Geodetic Accuracy Standards And Specifications For Using GPS Relative Positioning Techniques*, Federal Geodetic Control Subcommittee (FGCS), August, 1989.

http://www.ngs.noaa.gov/FGCS/tech_pub/GeomGeod.pdf

9.3.1.2 TPS Techniques

All TPS surveys for secondary horizontal project control shall meet the standards of at least 2nd Order Class II as defined in *Standards and Specifications for Geodetic Control Networks*, Federal Geodetic Control Committee (FGCC), September, 1984.

In order to qualify for angular adjustment, azimuth closure shall be less than $4.5\sqrt{N}$ where 4.5 is seconds of arc and N is the number of traverse segments.

After angular adjustment, in order to qualify for final adjustment, position closure ratio shall be a minimum of 1:**20,000**

SECONDARY PROJECT CONTROL

9.3.2 Secondary Vertical Project Control Standards

Secondary Vertical Project Control shall be established using trigonometric or differential leveling techniques as specified in [Chapter 8, Primary Vertical Project Control](#).

Elevations shall be established on Survey Baseline Stations in order to control any additional Terrain Data survey.

If bench marks are required on the project site, they shall be established from primary vertical project control using differential leveling techniques as specified in section [8.4.2.1. Differential Leveling](#). All bench marks shall be incorporated as turning points, in a primary or secondary level run.

To qualify for adjustment, level line error, expressed in feet, shall close within $0.03 \text{ ft. } \sqrt{D}$ where D is equal to the length of the level line in miles.

($8\text{mm } \sqrt{D}$ where D is equal to the length of the level line in kilometers)

9.4 PROCEDURES

FIGURE IX. TYPICAL SECONDARY PROJECT CONTROL SURVEY

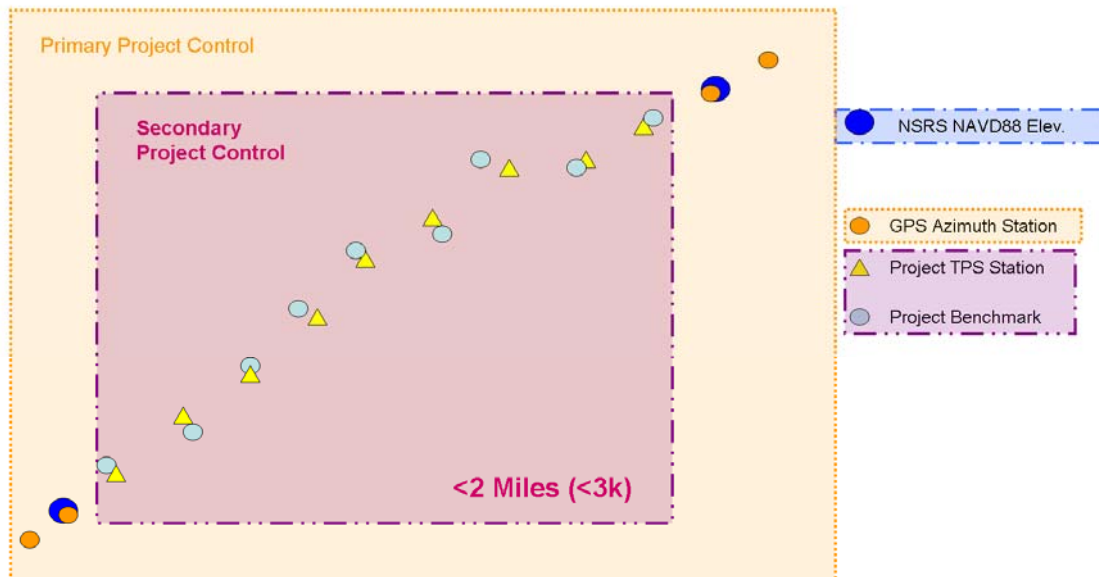

Not to Scale

SECONDARY PROJECT CONTROL

9.4.1 Secondary Horizontal Project Control Procedures

9.4.1.1 GPS Procedures:

Equipment

Surveyors shall employ dual frequency GPS receivers.

Techniques

Static or Fast Static GPS techniques may be employed.

Minimum 5 second epochs shall be collected for fast static techniques.

Minimum 15 second epochs shall be collected for static techniques.

Tracking elevation mask angle should be 10 deg.

Post-processing of simultaneous field observations shall be used.

Network Design

Static and Fast Static GPS surveys for Secondary Horizontal Project Control should be configured as networks of redundant vectors. Secondary project control, including Baseline Stations, and any other relatively short lines, shall have a minimum of two independent observations. Redundant vectors are accomplished only by completely independent occupations of stations. Independent occupations require that the tripod or stand be reset and replumbed between sessions. So-called spaghetti, radial, or traverse survey schemes shall not be used on NYSDOT capital projects. At least two primary horizontal project or CORS control stations shall be incorporated into the network design.

At least two primary horizontal project control stations shall be incorporated into the network design.

Network statistics shall meet the requirements for order C2-II as defined in *Geometric Geodetic Accuracy Standards And Specifications For Using GPS Relative Positioning Techniques*, Federal Geodetic Control Committee, August, 1989.

http://www.ngs.noaa.gov/FGCS/tech_pub/GeomGeod.pdf

100% of new stations shall be included in a loop. Loops shall include baselines from at least two different sessions. Loops may contain up to a maximum of 10 legs.

Planning

Proper planning and network design shall be used in GPS surveys for secondary project control.

Satellite almanacs used for observation planning shall be no more than 30 days old.

SECONDARY PROJECT CONTROL

Field reconnaissance and pre-mission observation planning shall be accomplished for all surveys. Sky visibility diagrams shall be made for all stations. Diagrams will show magnetic azimuth and elevation angle to all obstructions above 15° to whole degrees. Obstruction data shall be entered into a GPS observation planning program and multi-receiver sessions shall be analyzed for acceptable observing times. Analysis should consider the number of available satellites and PDOP.

At least four **healthy** satellites shall be observed in common at all simultaneously occupied stations.

The PDOP should not exceed 7 during any GPS survey observations.

Observation session lengths shall consider site obstructions, predicted PDOP, number of satellites available, network configuration, and manufacturer guidelines.

Field Observations

Fixed-height antenna tripods or survey tripods and optical plummet tribrachs shall be used for GPS antenna set-up over the points.

GPS observations will be collected at minimum of 5 second data epochs using fast static techniques, or minimum 15 second epochs using static techniques. The tracking elevation mask angle should be 10°.

Vehicles should be parked away from or below the GPS antenna to minimize the chances of causing multipath signals.

Great care shall be taken in measuring and recording antenna heights. When using standard tripods, the antenna slope-height will be measured multiple times (per manufacturer's directions) and the average recorded.

9.4.1.2 TPS Procedures

Traverse Geometry

Begin and end horizontal control traverses on monuments of at least second order, class II. TPS traverses should begin and end on primary project control azimuth pair stations. Use angular and position closure to terminate a traverse.

Azimuth checks should be made within every **2 miles (3 km)** with not more than 20 segments. Normally, traverse stations interval should be about **1000 ft. (300 meters)**, and shall be intervisible.

Effort shall be made to keep traverse legs balanced. Effort should be made to minimize crossing lanes of traffic. Line of sight should always be **2 ft. (0.5 meters)** above ground.

Equipment

The total station used for secondary project control should be at least a one-second (angle) and **0.003 ft. (1mm)** (distance) least-count instrument with Dual-Axis Compensation. The total station used should have a minimum DIN accuracy of two

SECONDARY PROJECT CONTROL

seconds (angle) and +2ppm (distance). The total station, tribrachs, prism targets, prism poles, tripods, etc. used for control surveys shall be adjusted properly and maintained in good condition.

All survey equipment, including tripods, tribrachs, prisms, etc. shall be properly maintained and calibrated according to manufacturers' guidelines. The [National Geodetic Survey \(NGS\) calibration baselines](#) established specifically for the checking of Electronic Distance Measuring Instruments (EDMI) may be used for checking the calibration of EDM's and reflectors. Equipment calibration records and reports (not exceeding one year) shall be maintained by the surveyor and submitted to the Department as requested.

<http://www.ngs.noaa.gov/CBLINES/BASELINES/ny>

Techniques

Observe temperature and atmospheric pressure and enter this data into the total station to correct the slope distance for atmospheric affects.

Account for prism offset in all distance measurements in the instrument settings.

A backsight of known azimuth should be used. Backsight and foresight targets should be tripod mounted.

Measure horizontal angles two times in sets of direct and reverse attitudes (2 direct and reverse (D&R)). The suggested procedure is to:

1. Sight the backsight with telescope direct.
2. Turn the angle right to the foresight.
3. Plunge the telescope and re-sight the foresight with the scope reversed.
4. Turn the angle right to the backsight.

This is one D&R.

The sum of the direct and reversed horizontal angles of a single set of angles should not deviate from 360° by more than 5.0 seconds. Re-observe, rejecting sets until two sets agree within this tolerance.

For total station instruments that include the capability, the vertical indexing initialization procedure should be checked at the beginning of each day.

Measure zenith angles used to reduce slope distance to its horizontal component in both the direct and reversed attitudes.

The sum of the direct and reversed zenith angles of a single set of angles should not deviate from 360° by more than 10.0 seconds. Re-observe the rejected sets until the two sets agree within this tolerance.

Measure all baseline distances electronically from both ends of each line.

SECONDARY PROJECT CONTROL

The slope distances (between adjacent control points) from forward and backward measurements should not differ by more than the amount that the precision of the EDM device allows.

9.4.2 Secondary Vertical Project Control Procedures

Secondary Vertical Project Control shall be established using trigonometric or differential leveling techniques. This should originate and terminate on bench marks of equal or higher order and class.

Network Geometry

Level runs shall begin and end on bench marks of appropriate accuracy classification order. Secondary Vertical Project Control Level Runs will normally begin and end on different Primary Vertical Project Control Stations as established under [Chapter 8](#). Use two different bench marks to begin and end vertical surveys. If leveling to a second bench mark is not practical or economical the regional Land Surveyor should be consulted for guidance.

When bench marks need to be established on the project site, the bench marks should be incorporated as turning points into a secondary vertical project control level-run using differential leveling techniques described in [9.4.2.1](#).

9.4.2.1 Differential Leveling

Equipment

Use only digital levels with bar code rods. Use a sectional composite or invar bar-code staff.

Techniques

Expend reasonable effort when balancing backsights and foresights. Use subsequent set-ups to make up for deficiencies in balancing. Difference in forward and backward sight lengths should never exceed **30 ft. (10 meters)** per setup or **30 ft. (10 meters)** per section. Maximum sight length should not exceed **230 ft. (70 meters)**. Minimum ground clearance of line of sight should be **2 ft. (0.5 meters)**.

9.4.2.2 Trigonometric Leveling

Equipment

The total station used for trigonometric leveling should be at least a one-second (angle) and **0.003 ft. (1mm)** (distance) least-count instrument with Dual-Axis Compensation. The total station used should have a minimum DIN accuracy of two seconds (angle) and **0.006 ft. (2mm)** +2ppm (distance). The total station, tribrachs, prism targets, prism poles, tripods, etc. used for control surveys shall be adjusted properly and maintained in good condition.

SECONDARY PROJECT CONTROL

Account for the correct prism offset in all distance measurements.

Always use a target device with a retro-flector prism. The reflector alone does not make an adequate vertical target. The target/reflectors shall be tripod mounted.

Techniques

Trigonometric Leveling may be incorporated in to the secondary horizontal project control traverse.

Limit sight distances to about **1000 ft. (300 meters)**. This minimizes the impact of small pointing errors. Longer sight distances may require additional pointings, resulting in a larger sample from which to derive a mean vertical angle.

Take great care in measuring the heights of instruments and targets for each set-up. Make redundant measurements to eliminate the chances of blunders. Make and record measurements at both the beginning and end of each occupation to check for settling, slipping, or misreading. When instruments and targets are exchanged on a tribrach, the HI or HT should be measured again. Never assume that they are the same or that the tripod hasn't deflected differently.

Make reciprocal observations (observations from each end of a line) on all observed lines. Observe each zenith angle with at least two D&R sets. The sum of the direct and reversed zenith angles of a single set of angles should not deviate from 360° by more than 10.0 seconds. Observe, once again, the rejected sets until the two sets agree within this tolerance.

The term *reciprocal observations* actually denotes zenith angles measured simultaneously from each end of a line. However, achieving simultaneous observations is rarely practical for highway surveying. In this case, zenith angle observations from each end of a line shall be separated by only a minimum amount of time in order to minimize any difference in the atmospheric conditions between stations during the observations. There are instances in which the atmospheric conditions are nearly identical during the times the zenith angles are observed at each end of the line. In these cases the effects of curvature and refraction on the zenith angle observations cancel out. However, there are other instances, in which atmospheric conditions change significantly between the occupation of one point and the next. For best results in these instances repeat all the observations for that baseline.

Reciprocal observations correct distances and zenith angles for the effects of earth curvature and refraction. Automatic curvature and refraction corrections, applied in the instrument settings, usually apply corrections to horizontal distances and vertical changes only and do not affect the slope distances and zenith angles that are collected as part of a raw reciprocal observation. Therefore, automatic curvature and refraction corrections, set at the instrument will have no effect on the reciprocal observation. When a line is observed from only one end, curvature and refraction corrections for determining vertical differences should be applied during processing.

SECONDARY PROJECT CONTROL

Always try to occupy the known (initial and final) bench marks and all new bench marks, in a trig level run. Reciprocal observations cannot be made to and from a point that is not occupied. If a bench mark cannot be occupied, set up the total station within **66 ft. (20 meters)** of it and observe (in direct and reverse) the foresight vertical difference only. The very short distance will minimize the atmospheric effects.

9.5 DATA PROCESSING

9.5.1 Horizontal

9.5.1.1 GPS

GPS survey observations for capital projects may be processed with the broadcast ephemeris.

Process baselines using a default elevation mask of 15 degrees. Alter elevation mask when necessary.

The quality of baselines shall be checked according to the software manufacturer's guidelines.

Loop closures should be analyzed. In any component (X,Y,Z), "maximum" misclosure, not to exceed **2 ft. (50 cm)**. In any component (X,Y,Z), "maximum" misclosure, in terms of loop length, not to exceed 60 ppm. In any component (X,Y,Z), "average" misclosure, in terms of loop length, not to exceed 40 ppm. Repeat Baselines should be analyzed. In any component (X,Y,Z), "maximum" not to exceed 50 ppm.

A minimal constrained adjustment should be performed holding one NSRS fixed in X,Y, and Ellipsoid Height. Adjustment residuals shall be analyzed for outliers. Once internal network accuracy is proven a fully constrained adjustment shall be performed. Adjustment residuals shall be analyzed. Outliers, if any, shall be identified, and coordinate differences shall be reported to the Regional Land Surveyor.

Expected setup errors shall be accounted for in the least squares adjustment program. Refer to [Geometric Geodetic Accuracy Standards and Specifications for Using GPS Relative Positioning Techniques, FGCC, 1989](#); Appendix D. Expected minimum/maximum antenna setup errors. For secondary project control an expected setup error of **0.010 ft. (0.3 cm)** should be used.

See [Section 8.5.1](#) for least squares adjustment guidelines.

9.5.1.2 TPS

The combined factor shall be applied to slope distances.

In order to qualify for angular adjustment, azimuth closure shall be less than $4.5\sqrt{N}$, where 4.5 is seconds of arc and N is the number of traverse segments.

SECONDARY PROJECT CONTROL

After angular adjustment, in order to qualify for final adjustment, position closure ratio shall be a minimum of 1:20,000

Adjust traverses to determine the final value of the coordinates and elevations assigned to control points.

Adjust single traverses by the Compass Rule. The method of least squares may be used whenever *network* observations (cross-ties) are incorporated into the scheme or when adjustment to other connected traverses need to be made simultaneously.

9.5.2 Vertical

To qualify for adjustment, level line error shall not exceed $.03 \text{ ft} \sqrt{D}$ where D is the length of the level line in miles (shall not exceed $8\text{mm} \sqrt{D}$ where D is equal to the length of the level line in kilometers).

SECONDARY PROJECT CONTROL

9.5.2.1 Differential Leveling

Differential level lines should be adjusted according to the number of turns between bench marks.

9.5.2.2 Trigonometric Leveling

Processing software used to reduce trigonometric leveling notes shall mean the change in elevation, forward and backward along the traverse legs, while accounting for the target heights at each observation.

Trigonometric level runs should be adjusted by apportioning the errors according to the distances of the legs.

9.6 QUALITY CONTROL

The licensed land surveyor in charge of the survey shall be responsible for the integrity and quality control of all survey data produced.

9.7 REPORTING

9.7.1 Field Notes

9.7.1.1 Horizontal

GPS

Raw data files along with RINEX files shall be submitted for secondary horizontal control surveys.

TPS

Raw data files shall be submitted which indicate the setup information, traverse observations, closure error between observation sets, and meaned traverse observations.

9.7.1.2 Vertical

Raw Data and processed files shall be submitted for secondary vertical project control surveys.

9.7.2 Survey Reports

The secondary project control is within the project area, and is used to control the engineering and real property acquisition work required for a project. The surveyor can use the survey report to demonstrate and document to the customer the integrity of the control survey. It can also be used to guide future users of the secondary project control.

SECONDARY PROJECT CONTROL

Use page separators with labeled tabs, to separate each section of the report for easy referencing.

9.7.2.1 Horizontal

GPS

Reporting of Secondary Horizontal Project Control should include and progress as follows:

See [Section 8.7.2.1 Horizontal \(GPS Survey Report\)](#).

TPS

Reporting of Secondary Horizontal Project Control should include and progress as follows:

Table of Contents, Introduction, Personnel (field and office, job titles and job function), licensed land surveyor's certification, equipment calibration records and reports,

Project site location map (showing the project location, the primary control monuments used, and the secondary control stations established).

Project Narrative stating: goals of project, standards to be achieved, primary Monuments used, secondary monuments established, Coordinate System/datum/zone, equipment and software used, etc. Describe the procedures used. Comments/Recommendations.

Network Diagram showing the survey baseline and the connections to the primary project control.

Control Data Sheets for the Primary Project Control Stations used.

Control Data Sheets for the secondary project control stations established.

Summary of misclosures, including:

- From/To
- Traverse length (Km)
- # of Traverse Stations
- Record Starting Azimuth
- Record Ending Azimuth
- Calculated ending azimuth
- Calculated angular misclosure
- Allowable angular misclosure (4.5" times the square root the number of angles)
- Error per angle
- Horizontal linear misclosure
- Horizontal linear precision ratio (1:20,000 minimum)

Unadjusted Coordinates

SECONDARY PROJECT CONTROL

Adjustment residuals by coordinates.

Adjustment residuals by observations.

Adjusted Coordinates reported in NYSPCS (shown to four decimal places) with orthometric heights shown to an appropriate significant value (**nearest hundredth of a foot) (nearest millimeter)** and accuracy statement for the survey per FGCC Specifications)

Combined Factor, Grid Scale Factor, and Ellipsoidal Reduction Factor applied to distances in the traverse.

Final adjusted angles and distances.

Horizontal control map (based on a suitable scaled plan, e.g. 1:6000, showing the location of all secondary project control monuments, relative to named cross streets and other prominent features).

9.7.2.2 Vertical

Differential and Trigonometric

Reporting of Secondary Vertical Project Control should include and progress as follows:

Table of Contents, Introduction, Personnel (field and office, job titles and job function), licensed land surveyor's certification, equipment calibration records and reports.

Project site location map (showing the project location, the primary vertical control stations/bench marks used, and the secondary vertical control stations/bench marks established.)

Project Narrative stating: goals of project, standards to be achieved, Primary bench marks used, secondary bench marks established, datum references, equipment and software, etc. Describe the procedures used. Comments/Recommendations.

A Summary table showing the summary of misclosures, including:

From/To
Benchrun Length (**Miles)(Km)**
of turning points
Record starting elevation
Record ending elevation
Calculated ending elevation
Calculated misclosure
Allowable misclosure (**0.03 times the square root of the length of run)**
(**0.008 times the square root of the length of run**)

SECONDARY PROJECT CONTROL

Network Diagram showing the level run sections/loops, and the network connections to the primary project control.

Control Data Sheets for the Primary Project Control bench marks used.

Control Data Sheets for the secondary project control bench marks established (elevations shown to the nearest **hundredth of a foot** or nearest **millimeter**)

Summary of adjustment method and statistics

Adjusted elevations reported in NAVD 88 shown to nearest **hundredth of a foot (millimeter)**, and accuracy statement for the survey (per FGCC Specifications).

Vertical control map (based on a suitable scaled plan, e.g. 1:6000, showing the location of all secondary project control bench marks, relative to named cross streets and other prominent features).

9.8 QUALITY CONTROL

The licensed land surveyor in charge of the survey shall be responsible for the integrity and quality control of all survey data produced.

9.9 REFERENCES

1. Geometric Geodetic Accuracy Standards and Specifications for Using GPS Relative Positioning Techniques, FGCC, 1989
http://www.ngs.noaa.gov/FGCS/tech_pub/GeomGeod.pdf
2. Federal Geodetic Control Committee's (FGCC) publication "Standards and Specifications for Geodetic Control Networks" published September, 1984
3. "NOAA Manual NOS NGS 3 Geodetic Leveling" dated August 1981
4. "Specifications and Procedure to Incorporate Electronic Digital/Bar Code Leveling Systems, version 4.0" published July 15, 1994 by FGCC.

10. PHOTOGRAMMETRIC CONTROL SURVEYS

PHOTOGRAMMETRIC CONTROL

10.1 INTRODUCTION

The purpose of this chapter is to specify the minimum standards and describe procedures for establishing photogrammetric control on NYSDOT capital projects.

When the term *photogrammetric control* is used in this manual it refers to the ground control targets or photo identifiable points occurring within the area of a project. The photo control can be selected before (pre-marking, e.g. targets), or after (post-marking, e.g. photo-identifiable points) the aerial photography flight. Whenever possible, targets should be used. Photo control is used to control the photogrammetric mapping and DTMs required for a project. Points established under these standards and procedures are generally within the work limits of the project and are assumed to be expendable.

Photogrammetric control traverses, level runs, and GPS networks should begin and end on at least secondary project control stations.

FIGURE X. Photogrammetric Control

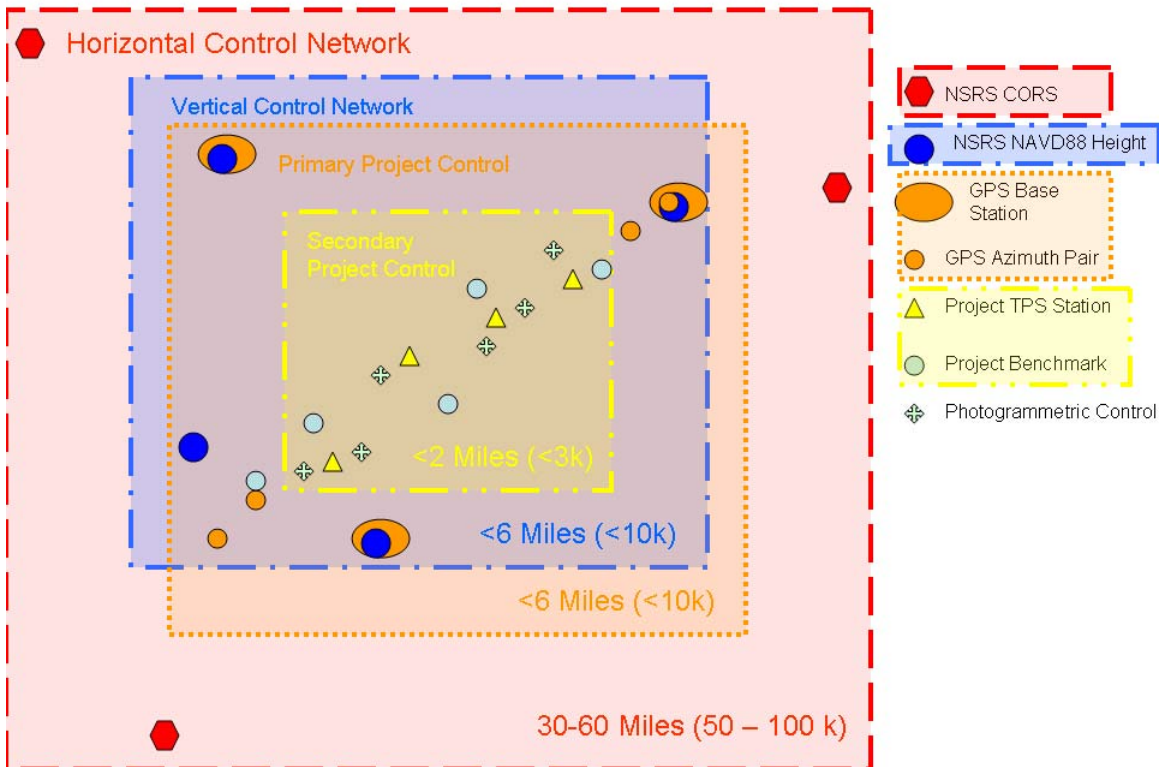

Not to Scale

PHOTOGRAMMETRIC CONTROL

10.2 MONUMENTATION

Aerial photo targets shall be placed in the field, to be used as photogrammetric control points. The targets shall be placed in accordance with the NYSDOT targeting diagram and “[Targeting Guidelines](#)”. Refer to the Photogrammetry Section’s targeting guidelines for proper placement of targets and other information.

Targets are considered to be expendable. Some temporary method of monumentation such as PK Nails or Spikes should be used in case there is a lapse in time between the photogrammetric flight and the control survey. Effort should be made to perform the survey as close to the aerial flight as possible, in order to minimize the loss of targets. Target placement shall consider survey method. If GPS method is going to be used, target obstructions shall be considered in order to be able to achieve a position using GPS techniques.

10.3 MINIMUM STANDARDS

Photogrammetric Horizontal Control shall be established using GPS or TPS techniques, to establish horizontal photo control in support of surveying and mapping operations at the project site.

10.3.1 Photogrammetric Horizontal Control Standards

10.3.1.1 GPS Techniques

All GPS surveys for photogrammetric control shall meet the standards of at least order C2-II as defined in [GEOMETRIC GEODETIC ACCURACY STANDARDS AND SPECIFICATIONS FOR USING GPS RELATIVE POSITIONING TECHNIQUES](http://www.ngs.noaa.gov/FGCS/tech_pub/GeomGeod.pdf), Federal Geodetic Control committee (FGCC), August, 1989. http://www.ngs.noaa.gov/FGCS/tech_pub/GeomGeod.pdf

10.3.1.2 TPS Techniques

Photogrammetric Horizontal Control Points can be located from a secondary control traverse or sub traverses, using a total station. Traverses shall meet the standards of at least 2nd Order Class II as defined in *Standards and Specifications for Geodetic Control Networks*, Federal Geodetic Control Committee (FGCC), September, 1984

10.3.2 Photogrammetric Vertical Control Standards

10.3.2.1 Differential Levelling Techniques

Photogrammetric Vertical Control Points can be located from a secondary control level run using a level. Vertical Control Points shall be incorporated as turning points, in a level loop.

Level line errors, expressed in **feet**, for level runs which include V.P.'s as turning points shall not exceed $.03 \text{ ft} \sqrt{D}$ where D is the length of the level line in miles (shall not exceed $8\text{mm} \sqrt{D}$ where D is equal to the length of the level line in kilometers).

10.3.2.2 TPS Techniques

Photogrammetric Vertical Control Points can be located from secondary vertical control, by trigonometric leveling, using a total station. Sub traverses which incorporate Vertical Control Points shall meet the standards of at least 2nd Order Class II as defined in

PHOTOGRAMMETRIC CONTROL

Standards and Specifications for Geodetic Control Networks, Federal Geodetic Control Committee (FGCC), September, 1984 and reflect a precision of at least 1:20,000.

Level line errors, expressed in feet, for traverses which include V.P.'s as turning points, shall not exceed $.03 \text{ ft} \sqrt{D}$ where D is the length of the level line in miles (shall not exceed $8\text{mm} \sqrt{D}$ where D is equal to the length of the level line in kilometers).

10.3.2.3 GPS Techniques

GPS surveys for photogrammetric control shall meet the standards of at least order C2-II as defined in *GEOMETRIC GEODETIC ACCURACY STANDARDS AND SPECIFICATIONS FOR USING GPS RELATIVE POSITIONING TECHNIQUES*, Federal Geodetic Control Committee (FGCC), August, 1989. http://www.ngs.noaa.gov/FGCS/tech_pub/GeomGeod.pdf

10.4 PROCEDURES

Photogrammetric control surveys can be conducted before or after aerial photography flights.

Photo control surveys conducted before flying should include the horizontal and/or vertical coordinates of *targeted points* (HPs & VPs). Aerial photo targets shall be placed in the field, to be used as photogrammetric control points. The targets shall be placed in accordance with the NYSDOT targeting diagram and "[Targeting Guidelines](#)". A hand-held GPS receiver shall be used to determine the approximate coordinates of the actual target locations, and a text file with the approximate coordinates shall be submitted. Refer to the Photogrammetry Section's targeting guidelines for proper placement of targets and other information.

<http://intradot/design/dsb/photo/at/guideline2000.pdf>

Target placement should also take in to consideration the survey method to be used for locating the target.

Photo control surveys conducted after flying should include the horizontal and/or vertical coordinates of HPs and VPs (photo identifiable points), which were found by the photogrammetrist to be readily and discretely identifiable on aerial photos. Photo control points that are relocated in the field need to be communicated to the photogrammetrist.

The coordinates of H.P.'s and V.P.'s should be determined by inclusion in a GPS Network, a closed subtraverse or run of levels respectively. When located as sideshots from a traverse or as RTK GPS observations, an appropriate method of redundant observations should be employed.

RTK GPS has become the preferred method of surveying photogrammetric control, based on accuracy and efficiency. In particular the use of RTK GPS and the NYSNet CORS RTN is being used successfully to survey photogrammetric control. Other survey methods may still be acceptable, but RTK has been found to be the most efficient method. Consult with the Regional Land Surveyor for approval to use other survey methods.

10.4.1 Horizontal

10.4.1.1 GPS Techniques

Equipment

PHOTOGRAMMETRIC CONTROL

Surveyors shall employ dual frequency GPS receivers. Not less than two GPS receivers shall be employed during an observation session, at least one reference base station receiver and one rover receiver. When using the NYSNet RTN, using just one rover receiver meets this requirement. Fixed height tripods should be used at GPS base stations. Fixed height tripods or a bipod/GPS pole should be used at target locations.

Techniques

Static or Dynamic (Fast Static, Kinematic) techniques may be employed. Real Time Kinematic (RTK) using primary project control base stations (Local RTK) or Network RTK (NRTK) using the NYSNet RTN (Real Time Network) can be used.

Minimum of 15 second epochs will be collected for static techniques.

Minimum of 5 second epochs will be collected for fast static or kinematic techniques.

1 second epochs should be used for RTK techniques.

Tracking elevation mask angle should be 10 deg.

Post-processing of simultaneous static field observations or RTK shall be used.

Network Design

GPS surveys for Photogrammetric Control should be configured as networks of redundant vectors. Photogrammetric control, including targets and photo identifiable points, shall have two independent observations. Redundant vectors are accomplished only by completely independent occupations of stations. Independent occupations require that the tripod or stand be reset and replumbed between sessions. So-called spaghetti, radial, or traverse survey schemes shall not be used on NYSDOT capital projects.

At least three horizontal control stations, being in different quadrants shall be incorporated into the network design (i.e. azimuth pair stations/base stations that meet the required standards for C1 order, or NRTK using the NYSNet RTN).

All photo control points observed shall have two independent occupations. Each of these two occupations will be made at a time of day separated by a minimum of 20 minutes sidereal time displacement (start time to next start time). ~~Each of these two occupations will be tied to two different base stations.~~ The baselines that were used to establish the Primary Control Base Stations should be enabled for the photo control network processing so that only independent baselines are used for loop closures and adjustment.

Network statistics shall meet the requirements for order C2-II as defined in [GEOMETRIC GEODETIC ACCURACY STANDARDS AND SPECIFICATIONS FOR USING GPS RELATIVE POSITIONING TECHNIQUES](http://www.ngs.noaa.gov/FGCS/tech_pub/GeomGeod.pdf), Federal Geodetic Control Committee, August, 1989. http://www.ngs.noaa.gov/FGCS/tech_pub/GeomGeod.pdf

100% of new stations shall be included in a loop. Loops shall include baselines from at least two different sessions. Loops may contain up to a maximum of 10 legs.

Planning

Proper planning and network design shall be used in GPS surveys for photogrammetric control.

PHOTOGRAMMETRIC CONTROL

Base stations used should be as unobstructed as possible. Target locations should be placed in consideration of sky visibility and obstructions. Refer to the Photogrammetry Section's targeting guidelines for proper placement of targets and other information.

<http://intradot/design/dsb/photo/at/guideline2000.pdf>

Field reconnaissance and pre-mission observation planning will be accomplished for all surveys. Analysis should consider the number of available satellites and PDOP.

At least four healthy satellites shall be observed in common at all simultaneously occupied stations.

The PDOP should not exceed 7 during any GPS survey observations.

Final choice of observation session lengths shall also consider site obstructions, predicted PDOP, number of satellites available, network configuration, and manufacturer guidelines.

Field Observations

GPS antennas should be set up over the base stations and photo control points using fixed-height antenna tripods or a pole with bipod.

Vehicles should be parked away from or below the GPS antenna to minimize the chances of causing multipath signals.

Great care shall be taken in measuring and recording antenna heights. When using standard tripods, the antenna slope-height will be measured multiple times (per manufacturer's directions) and the average recorded.

NYS DOT experience has found the following RTK or Fast Static procedures will provide assurance that a photogrammetric control survey will be completed successfully without the need for return trips to the field:

PHOTOGRAMMETRIC CONTROL

FIGURE XI. NRTK Photogrammetric Control Survey

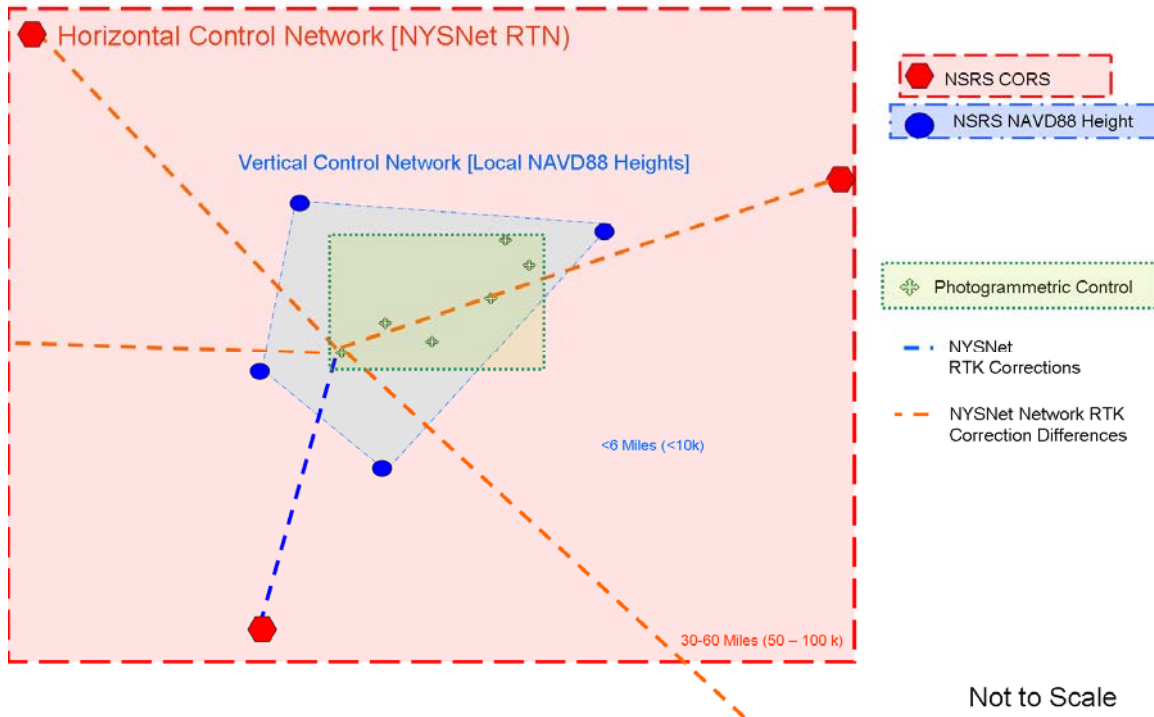

Network RTK (NRTK)

Network RTK corrections, from the NYSNet Real Time Network (RTN), shall be used. NAVD88 heights should be localized by either:

- Confirming heights produced from a GEOID model are consistent with NAVD88 Heights at the project.
- Computing local transformation parameters to 4 valid NAVD88 Heights surrounding the project. The maximum residual for control stations used to determine these transformation parameters shall be 0.1 feet (3 cm).
- Computing a 1 point mean shift transformation to an NAVD88 height, and leveling through project to confirm GPS derived heights.
- Computing a 2 point mean shift transformation to 2 valid NAVD88 heights on the project.

Use of a 3 point transformation to local NAVD88 heights may introduce a tilt to the transformation parameters and shall not be used.

Transformation parameters, for a local coordinate system may have to be determined if the project coordinate system datum is different from the NYSNet RTN coordinate system datum. If this is required, the maximum residual for control stations used to determine these transformation parameters shall be 0.06 feet (2 cm).

After determining local height transformation parameters, and applying them at the rover, check shots on other project control stations, should be observed to assure transformation parameters are correct.

Observations should only be started once ambiguities have been fixed. Some method of checking the integrity of the ambiguity resolution shall be used.

1 Second Observation Epochs or less shall be used for RTK.

At least 6 one second epochs shall be collected per occupation.

PHOTOGRAMMETRIC CONTROL

A position quality of 0.03 feet (1cm) and height quality of 0.06 feet (2cm) shall be achieved; otherwise, additional epochs shall be collected until these are achieved. If this cannot be achieved, other survey methods should be used.

Targets shall have 2 independent occupations at a time of day separated by a minimum of 20 minutes sidereal time displacement (start time to next start time).

Independent occupations shall agree within 0.07 feet (2 cm) horizontal, and .10 feet (3cm) vertical. Occupations that do not meet this criterion shall be reobserved. The averaged position, using these independent occupations, meeting these criteria, shall be reported as the surveyed target position.

FIGURE XII. Local RTK Photogrammetric Control Survey

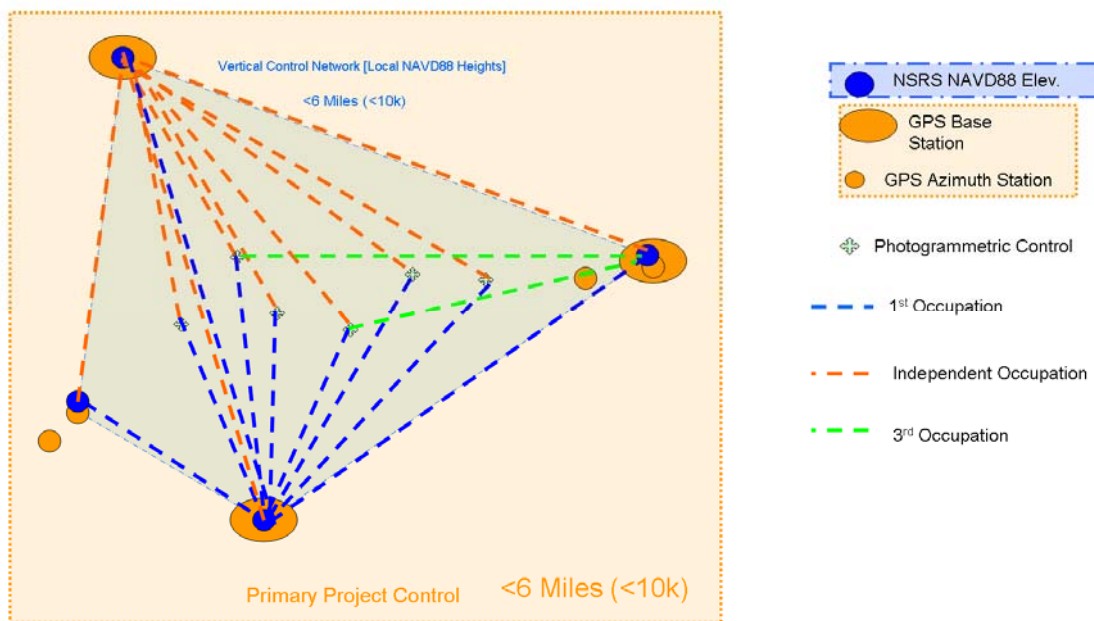

Not to Scale

Local RTK (LRTK)

Observations should only be started once ambiguities have been fixed. Some method of checking the integrity of the ambiguity resolution shall be used.

1 Second Observation Epochs or less shall be used for RTK.

At least 6 one second epochs shall be collected per occupation.

A position quality of .03 feet (1cm) and height quality of .06 feet (2cm) shall be achieved; otherwise, additional epochs shall be collected until these are achieved. If this cannot be achieved, other survey methods should be used.

At least four local control stations, with valid NAVD88 heights should be incorporated into the real time network. Targets shall have 2 independent occupations at a time of day separated by a minimum of 20 minutes sidereal time displacement (start time to next start time). The second observation must be from a second base station. 20 percent of the targets should be occupied a third time, using a third base station. During each session, observations should be made from the session base station, to the other base stations in the real time network.

Independent occupations shall agree within .07 feet (2 cm) horizontal, and .10 feet (3cm) vertical. Occupations that do not meet this criterion shall be reobserved. The averaged

PHOTOGRAMMETRIC CONTROL

position, using these independent occupations, meeting this criteria, shall be reported as the surveyed target position.

FIGURE XIII. Fast Static Photogrammetric Control Survey

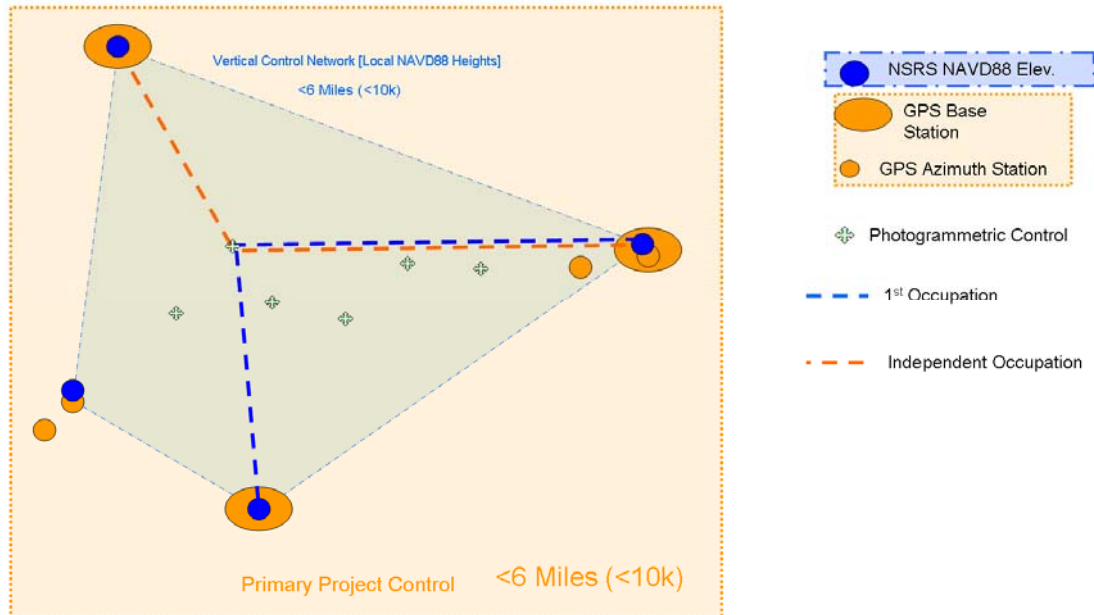

Not to Scale

Fast Static

At least three primary horizontal project control stations, being in different quadrants shall be incorporated into the network design (i.e. azimuth pair stations or base stations surveyed to primary project control GPS Base Station Standards). NYSDOT experience has found the following procedure will provide assurance that a photogrammetric control survey will be completed successfully without the need for return trips to the field: Occupy two primary project control stations as base stations, rove through the targets, move one base station to a third primary project control station, in a different quadrant, rove to the targets again with two base stations running.

10.4.1.2 TPS Technique

Network Geometry

Photogrammetric HP's can be located directly from a secondary project control baseline station or can be incorporated in a sub-traverse. When locating from a secondary project control survey baseline station as a sideshot, some method of redundant observations shall be employed. The HP shall be located from another secondary project control baseline station, or multiple observations shall be recorded to the target. When incorporating an HP in a sub-traverse the traverse shall begin and end on a secondary project control baseline station, with the required azimuth and position closures.

PHOTOGRAMMETRIC CONTROL

Equipment

The total station used for photogrammetric project control shall be at least a one-second (angle) and **0.003 ft. (1 mm)** (distance) least-count instrument with Dual-Axis Compensation. The total station used should have a minimum DIN accuracy of two seconds (angle) and **0.006 ft. (2 mm) +2ppm** (distance). The total station, tribrachs, prism targets, prism poles, tripods, etc. used for control surveys shall be adjusted properly and maintained in good condition

Techniques

When traversing for photogrammetric control the standards and procedures for secondary project control shall be followed.

When locating a target from a secondary project control traverse, the following procedures shall be followed:

Observe temperature and atmospheric pressure and enter this data into the total station to correct the slope distance for atmospheric affects.

Account for prism offset in all distance measurements in the instrument settings.

A backsight of known azimuth shall be used. Backsight targets should be tripod mounted.

The foresight target should be tripod mounted or mounted on a prism pole with bipod.

Measure horizontal angles one time in a set of direct and reverse attitudes (1 D&R). The suggested procedure is to:

1. sight the backsight with telescope direct
2. turn the angle right to the foresight
3. plunge the telescope and re-sight the foresight with the scope reversed
4. turn the angle right to the backsight

This is one D&R.

The sum of the direct and reversed horizontal angles of a single set of angles should not deviate from 360° by more than 5.0 seconds. Re-observe, rejecting sets until the two sets agree within this tolerance.

For total station instruments that include the capability, the vertical indexing initialization procedure should be checked at the beginning of each day.

Measure zenith angles used to reduce slope distance to its horizontal component in both the direct and reversed attitudes.

The sum of the direct and reversed vertical angles of a single set of angles should not deviate from 360° by more than 10.0 seconds. Observe, once again, the rejected sets until the set agrees within this tolerance. Measure all distances electronically in both direct and reverse attitudes.

PHOTOGRAMMETRIC CONTROL

10.4.2 Vertical

10.4.2.1 Differential Leveling Technique

Network Geometry

Level runs shall begin and end on primary or secondary project control stations.

Equipment

Use only automatic levels or digital levels. With digital levels a sectional composite or invar bar-code staff should be used

Field Procedures

Expend reasonable effort when balancing backsights and foresights. Use subsequent set-ups to make up for deficiencies in balancing. Difference in forward and backward sight lengths should never exceed **30 ft. (10 meters)** per setup or **30 ft. (10 meters)** per section. Maximum sight length should not exceed **230 ft. (70 meters)** Minimum ground clearance of line of sight should be **2 ft. (0.5 meters)**

Photogrammetry Targets or photo identifiable points shall be incorporated as turning points in a sub loop.

10.4.2.2 TPS Technique

Photogrammetric Vertical Control Points can be located from a secondary project control baseline, using secondary project control TPS [trigonometric leveling](#) techniques.

Trigonometric Level line errors, expressed in **feet**, for level runs which include V.P.'s as turning points, shall not exceed $.03 \text{ ft} \sqrt{D}$ where D is the length of the level line in miles (shall not exceed $8\text{mm} \sqrt{D}$ where D is equal to the length of the level line in kilometers).

10.4.2.3 GPS Technique

Techniques in [Section 10.4.1.1 Horizontal Photogrammetric Control GPS Techniques](#) can be followed to establish elevations on vertical photogrammetric control targets or PIPs. The primary project control stations incorporated in the vertical GPS Network, as base stations, shall be Primary Vertical Control Stations established in accordance with [Section 8.4.2 Primary Vertical Project Control](#).

PHOTOGRAMMETRIC CONTROL

10.5 DATA PROCESSING

10.5.1 Horizontal

10.5.1.1 GPS

GPS survey observations for capital projects may be post processed with the broadcast ephemeris.

Process baselines using a default elevation mask of 15 degrees. Alter elevation mask when necessary.

The quality of baselines shall be checked according to the software manufacturer's guidelines.

Loop closures should be analyzed. In any component (X,Y,Z), "maximum" misclosure, not to exceed **2 ft. (50 cm)** In any component (X,Y,Z), "maximum" misclosure, in terms of loop length, not to exceed 60 ppm. In any component (X,Y,Z), "average" misclosure, in terms of loop length, not to exceed 40 ppm.

Repeat Baselines should be analyzed. In any component (X,Y,Z), "maximum" not to exceed 50 ppm.

A minimal constrained adjustment should be performed holding one primary project control base station fixed in X, Y, and Ellipsoid Height. Adjustment residuals shall be analyzed for outliers. Once internal network accuracy is proven a fully constrained adjustment shall be performed. Adjustment residuals shall be analyzed. Outliers, if any, shall be identified, and coordinate differences shall be reported to the Regional Land Surveyor.

Expected setup errors shall be accounted for in the least squares adjustment program. For photogrammetric control, using a tripod to locate targets, an expected setup error of **0.02 ft (0.5 cm)** should be used.

See [Section 8.5.1 Primary Horizontal Project Control Data Processing](#) for least squares adjustment guidelines.

10.5.1.2 TPS

Follow [Section 9.5.1.2 Secondary Project Control Data Processing](#) procedures when incorporating traversing into photogrammetric control

When observing targets or photo identifiable points with a total station, the combined factor shall be applied to slope distances.

10.5.2 Vertical

10.5.2.1 Differential Leveling

To qualify for adjustment, level line error shall not exceed $.03 \text{ ft} \sqrt{D}$ where D is the length of the level line in miles (shall not exceed $8\text{mm} \sqrt{D}$ where D is equal to the length of the level line in kilometers).

PHOTOGRAMMETRIC CONTROL

Differential level lines should be adjusted according to the number of turns between bench marks.

10.5.2.2 TPS

When incorporating targets in a traverse, follow [9.5.1.2 Secondary Project Control Data Processing guidelines](#).

When locating targets as sideshots from a secondary project control traverse, observation sets shall be meaned.

10.5.2.3 GPS

Processing guidelines for establishing secondary project control with GPS in [section 9.5.1.1](#) should be followed.

10.6 QUALITY CONTROL

The land surveyor in charge of the survey shall be responsible for the integrity and quality control of all survey data produced.

10.7 REPORTING

10.7.1 Field Notes

10.7.1.1 Horizontal

GPS

Raw data files along with RINEX files shall be submitted for secondary horizontal control surveys.

TPS

Raw data files shall be submitted which indicate the setup information, traverse observations, sideshot observations, closure error between observation sets, and meaned observations.

10.7.1.2 Vertical

Raw Data and processed files shall be submitted for secondary vertical project control surveys.

10.7.2 Survey Reports

The Survey Report for Photogrammetric Control, in addition to the information required below, requires a [Survey Submission Memo](#) as specified by the Photogrammetry Section.

http://axim22.nysdot.private:7779/pls/portal/docs/PAGE/WCC_PG/DESIGN_DIVISION/P_HOTOGRAMMETRY_SECTION/AEROTRIANGULATION_UNIT/RF99.PDF

The survey submission memo requires target locations be submitted in digital form.

A comma delimited ascii text file of target coordinates shall include

A header listing:

Coordinate System, Datums, Units, GEOID Model and Combined project scale factor

The body of the report shall include:

Point ID, Northing, Easting, Orthometric Height, Standard Deviation in N, E, Height.

PHOTOGRAMMETRIC CONTROL

10.7.2.1 Horizontal

GPS

See [section 8.7.2.1](#) for primary project control reporting requirements.

TPS

See [section 9.7.2.1](#) TPS section for secondary project control reporting requirements.

10.7.2.2 Vertical

Differential Leveling

See [section 9.7.2.2](#) for secondary project control.

TPS

See [section 9.7.2.2](#) for secondary project control.

GPS

See [section 8.7.2.1](#) for primary project control.

10.8 REFERENCES

1 Geometric Geodetic Accuracy Standards and Specifications for Using GPS Relative Positioning Techniques, FGCC, 1989

http://www.ngs.noaa.gov/FGCS/tech_pub/GeomGeod.pdf

2. Survey Submission Memo” as specified by the Photogrammetry Section.

<http://intradot/design/dsb/photo/at/rf99.pdf>

3. Targeting guidelines for proper placement of targets.

http://axim22.nysdot.private:7779/pls/portal/docs/PAGE/WCC_PG/DESIGN_DIVISION/P_HOTOGRAMMETRY_SECTION/AEROTRIANGULATION_UNIT/TARGET2005.PDF

11. TERRAIN DATA (TOPOGRAPHIC) SURVEYS

TERRAIN DATA (TOPOGRAPHIC) SURVEYS

11.1 INTRODUCTION

This chapter establishes standards and procedures for producing surveying products needed for the [NYSDOT project development process](#). Adhering to these standards and procedures is required to ensure that the customer (design, photogrammetry, construction, contractor, etc.) receives a consistent and reliable product. There are three basic survey products delivered to the [design engineer](#). Base Mapping (**Mapping**), Digital Terrain Models (**DTMs**), and a Coordinate Geometry (COGO) Database (**Geometry**).

All mapping, DTM, and geometry features for Terrain Data surveys shall be located directly from secondary project control using a Total Station Positioning System (TPS) and radial surveying techniques, except when alternative survey data collection systems are approved for use by the Department, (see Section [11.2](#)).

Positional accuracy standards for terrain data surveys are to be considered a local (relative) accuracy. Local accuracy being defined as the repeatability of feature to feature connections at 95 % (2 Sigma) confidence. This means connections between features of similar positional accuracy should agree within the true position or distance within the accuracy stated, at a 95% confidence level. When using procedures other than those specified in this manual, positional accuracy standards should be tested and reported by comparing a random sample of positions determined by the proposed technique with positions determined using techniques that achieve a higher order of accuracy such as a TPS and radial survey techniques.

Base Mapping, DTMs and geometry shall conform to NYSDOT CADD [Software Standards](#) and the [CADD Standards and Procedure Manual](#).

For the purpose of these standards, there is no difference in feature accuracies between the three deliverable products (mapping, DTM and the geometry). All existing point features are collected in the same field process. Existing point features are collected from a secondary project control survey baseline using radial surveying techniques. Coordinates for all existing features collected by survey shall be consistent through the mapping, DTM and geometry.

Point and line Survey data shall be collected using automated mapping control coding and NYSDOT feature coding. The geometry, mapping and DTM features shall be collected in the same survey data collection process using naming convention as stated in the [CADD Standards and Procedure Manual](#). Mapping control coding shall control 3d line generation and DTM feature types. Feature coding will match [NYSDOT CADD Standard feature naming](#) convention and shall control automated symbology, attributing, and DTM types.

All existing features collected by survey shall be included in a DTM. DTM accuracy is not only dependent upon point feature and line accuracy but also upon point spacing/frequency, break line location and DTM feature type. NYSDOT's DTM software standard uses triangulation based terrain modeling. While all mapping features are included in the DTM, not all features are included in the triangulated network. Default DTM types are defined in the NYSDOT CADD survey feature table. The surveyor shall control what features are included in the triangulated network, using feature coding and control coding, so that the DTM surface is representative of the terrain.

Refer to the [Highway Design Manual](#), 5.4 Terrain Data Requirements, for guidance on design terrain data requirements by project type.

TERRAIN DATA (TOPOGRAPHIC) SURVEYS

11.2 ALTERNATIVE TERRAIN DATA COLLECTION SYSTEMS

Alternative terrain (survey) data collection systems such as terrestrial LIDAR (laser scanning) or RTK GPS may be approved for use by the Department as long as the required positional accuracy for terrain data surveys is tested and certified as achieving the minimum standards by comparing it to accepted methods. The alternative survey positioning systems shall also provide feature coding and mapping control coding techniques compatible with NYSDOT CADD Standard Software in order to provide the Department standard survey product deliverables.

11.3 MINIMUM STANDARDS

All *mapping, DTM and geometry* features for terrain data surveys shall be located directly from secondary project control using a TPS and radial surveying techniques. Other survey data collection systems may be approved for use as per [Section 11.2](#) above.

11.3.1 Point Features

Point feature accuracies are dependent upon how definable the feature is in the field and vary depending upon type of feature. For example the location of a real property marker or corner of a building may be more definitive than the center of a tree or an elevation break line in a field.

11.3.2 Linear Features

Linear feature alignments are created by the surveyor using mapping control coding. Linear feature alignment definitions should be consistent through the mapping, DTM and COGO database. Linear feature alignment accuracies are not only dependent upon point feature accuracies, but also point feature spacing/frequency, and alignment type (curve or linear).

11.3.3 DTM Features

DTM features are a combination of both point and linear features. All existing features shall be incorporated into the DTM and should be consistent through the mapping, DTM and COGO database. DTM accuracies are not only dependent upon point feature accuracies, and line feature accuracies, but also point and break line spacing/frequency, and DTM feature type.

11.4 FIELD PROCEDURES

11.4.1 Feature Location Procedures

All features for Terrain Data surveys shall be located directly from secondary project control using a TPS and radial surveying techniques. Other survey data collection systems may be approved for use as per [Section 11.2](#).

The total station used shall be at least a five second least-reading instrument. The total station used should have a minimum DIN accuracy of five seconds (angle) and **0.01 ft.(2mm)+2ppm** (distance).

TERRAIN DATA (TOPOGRAPHIC) SURVEYS

Linear features shall be created from Point features for all existing linear features. Surveyors should use mapping control coding in order to store point features into an alignment definition.

Automated data collection is typically required. An example of the procedures typically used with automated data collection by NYSDOT is described below.

Set-up

Atmospheric refraction corrections are set on the instrument.

Prism offset is accounted for in all distance measurements on the instrument.

The height of the backsight target and height of instrument are measured and recorded.

The instrument is pointed at the backsight and the horizontal angle, the zenith angle and slope distance are recorded by the data collector.

The height of the reflector on the range pole is measured and entered. It is important to measure the actual target (rod) height and not rely on graduation marks.

Operation

With the prism/target mounted on top, the rod person sets the rod on the point to be measured and holds the rod plumb.

The instrument operator sights the pole-mounted prism/target with the total station.

On command, the total station measures the slope distance and horizontal and zenith angles to the point and sends the data to the data collector.

The operator enters mapping control coding, feature coding and attribute information.

This measurement operation continues until all relevant features have been mapped.

RADIAL SURVEYING TECHNIQUES

Well defined Features

When locating well defined features such as Control and Bridge features (refer to [CADD Standards and Procedure Manual](#)) procedures should be used in order to achieve the required positional accuracy tolerances.

Existing monuments and bench marks encountered in the field should be located by inclusion in the baseline or run of levels, or located as *sideshots by some*

TERRAIN DATA (TOPOGRAPHIC) SURVEYS

method utilizing redundant observations. Monuments include government and private survey monuments, control points, and Real Property Monuments.

A properly adjusted Prism Pole Rod with target and level shall be used. A bipod can be used.

Marginally Defined Features

When locating marginally defined features such as, Drainage Features (Culverts, Pipes, Inverts, Structures, Wingwalls) Pavement Features, Landscape Features (Buildings) and Roadway Buffer Features (refer to [CADD Standards and Procedure Manual](#)), procedures should be used in order to achieve the required positional accuracy tolerances.

The detail required of a survey involving drainage structures varies depending on the scope of the project design. In general, however, more detailed information is required for structures to be rehabilitated than for those which need to be replaced. The extent of information that shall be acquired in the field for rehabilitated structures depends on the availability of record plans. All record plan information which is critical to the rehabilitative design should be verified in the field.

When a project involves a structure for a new road, where there is a history of flooding, or where changes in watershed area have occurred, hydraulic cross sections may be required. See [section 13.2](#) for hydraulic cross section requirements.

A properly adjusted Prism Pole Rod with target shall be used. Care should be taken so that the prism pole is positioned in order to achieve the positional accuracy standards.

Poorly Defined Features

When locating poorly defined features such as Drainage Features (Other), Landscape Features (Other), Erosion Control Features, Geotech Features, Striping and Signing Features, Traffic Control Features, Utility Features, a standard of care should be used in order to achieve the required positional accuracy tolerances.

A properly adjusted Prism Pole Rod with target should be used. The center of objects should be estimated within the positional tolerance and offset control codes should be used so that the positional accuracy standards are achieved.

TERRAIN DATA (TOPOGRAPHIC) SURVEYS

Utility Facilities

Coordination among the surveyor, customer (usually the designer) and regional utility engineer is advised, especially in industrial or urban areas.

Generally, all above-surface utility facilities should be located and described. Manholes and other confined spaces should be entered only by properly equipped experts. Electrical manholes never should be probed or sounded for dimension or elevation.

Do not enter areas fenced or cordoned off for safety. Where utility facilities are off the right-of-way, see [Section 3.5](#).

Rock Face Surveys

Surveying on near-vertical surfaces is always dangerous. The health and safety of crew members never shall be compromised, nor should the cost of the endeavor outweigh the benefits. Surveying any rock face presents potential safety problems. Obtaining the *distance* component of each shot may be dangerous as well as difficult.

[Fall Protection](#) training is required for all NYSDOT personnel for working on rock faces, cliffs, steep slopes, over water, etc. This activity may require specific safety equipment. The NYSDOT regional safety officer can arrange fall protection training for NYSDOT surveyors, as well as assist in obtaining necessary fall protection gear. The NYSDOT regional safety officer also can assist the regional survey manager in ensuring that consultant surveyors' personnel have received proper training.

Use of the range pole-mounted reflector is often inappropriate when surveying rock faces. In instances where points are accessible, reflectorless EDM's or Laser Scanning, may be useful alternatives. If points are inaccessible it may be possible to lower by rope a sheet of plywood, metal or plastic with a button reflector mounted on it. In all the instances just discussed, the surveyor chooses from the available tools and instruments those best suited in a specific situation.

When terrestrial photogrammetry is used to survey rock faces it is important to use caution. The same techniques described above should be used. There are, however, two important differences. First, when photogrammetry is used, the control points are located redundantly. Secondly, they shall be photo-discernible.

Where rock face surveys are required along a road or other vehicle-accessible area, the observations may be obtained using "reflectorless" electronic distance measuring technology.

TERRAIN DATA (TOPOGRAPHIC) SURVEYS

11.4.2 Feature Naming

All features shall be named as specified in the [CADD Standards and Procedure](#) Manual. The diagrams below are interpretations of the Standard CADD Feature Naming Convention:

TERRAIN DATA (TOPOGRAPHIC) SURVEYS

FIGURE XIV. Standard Feature Naming

TERRAIN DATA (TOPOGRAPHIC) SURVEYS

Pavement/Roadway/Landscape

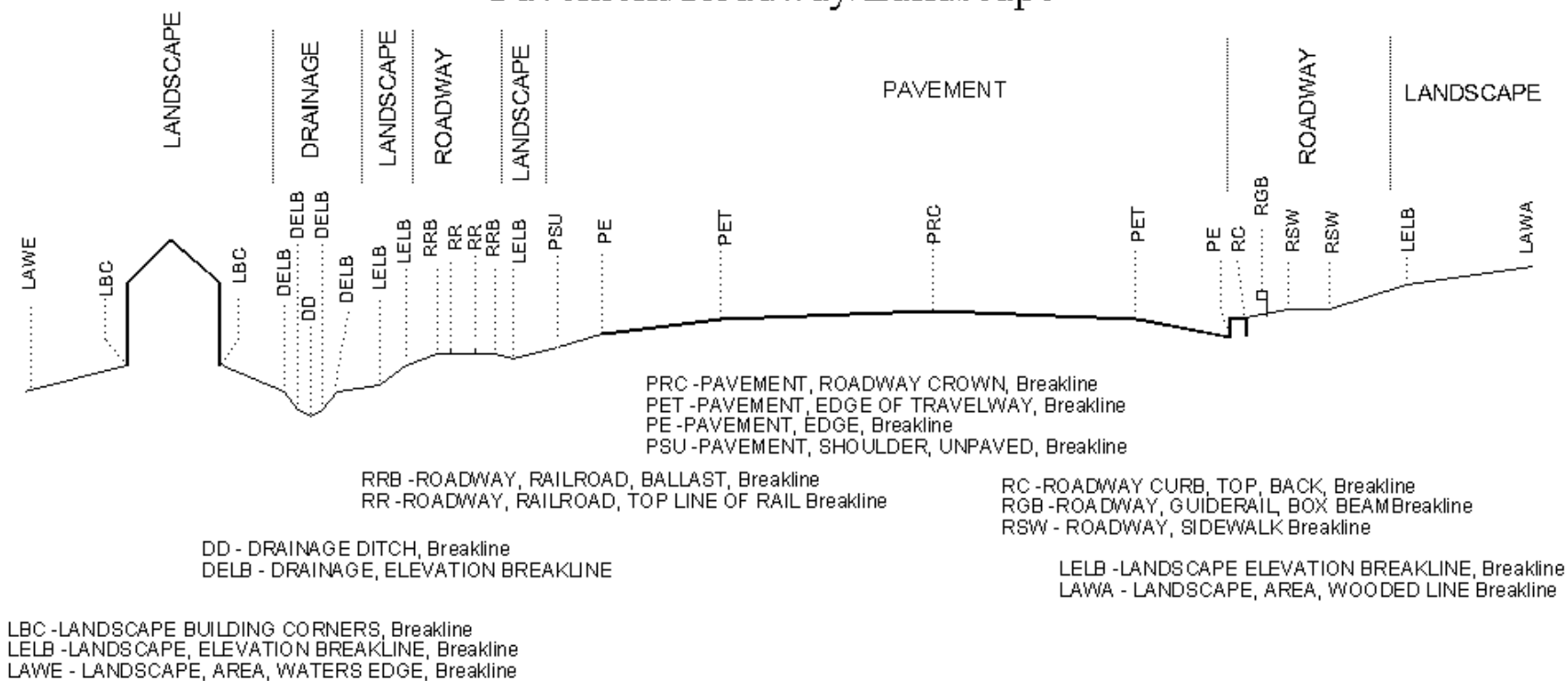

TERRAIN DATA (TOPOGRAPHIC) SURVEYS

Bridge, Deck

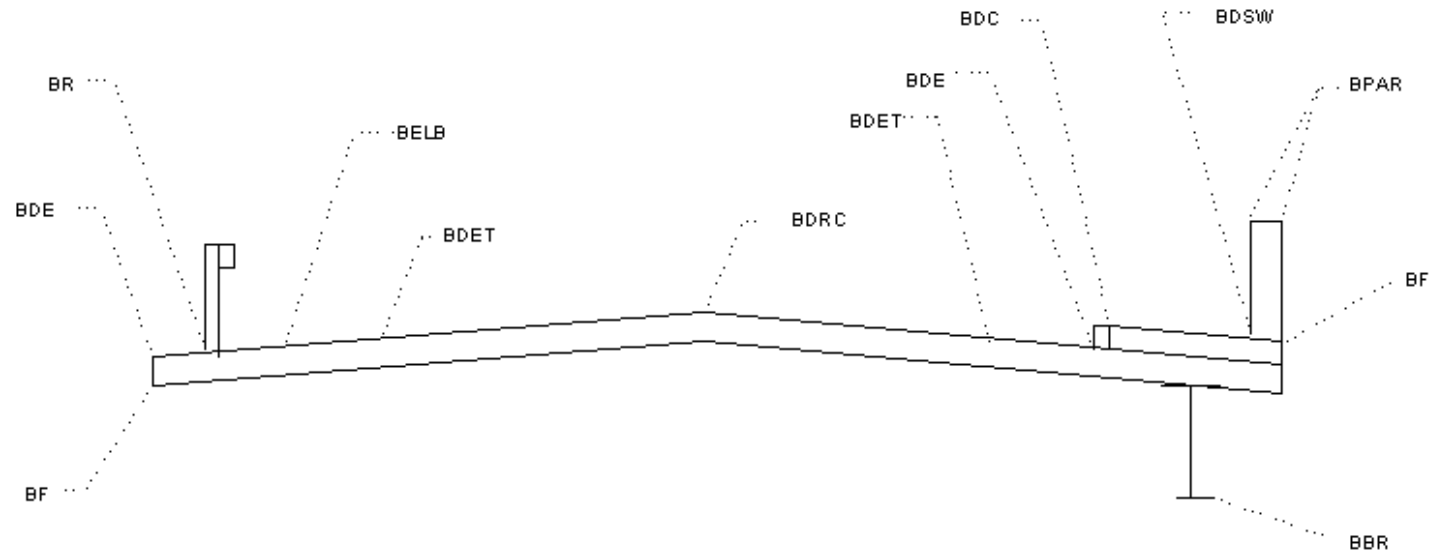

BF - BRIDGE, FACIA, DNC
BDE - BRIDGE, DECK, EDGE, Breakline
BR - BRIDGE, RAIL, Breakline
BELB - BRIDGE, ELEVATION BREAK, Breakline
BDET - BRIDGE, DECK, EDGE OF TRAVELWAY, Breakline
BDRC - BRIDGE, DECK, ROADWAY CROWN, Breakline
BDC - BRIDGE, DECK, CURB, BACK, Breakline
BDSW - BRIDGE, DECK, SIDEWALK, Breakline
BPAR - BRIDGE, PARAPET, Breakline
BBR - BRIDGE, BEAM, ROLLED

TERRAIN DATA (TOPOGRAPHIC) SURVEYS

Bridge

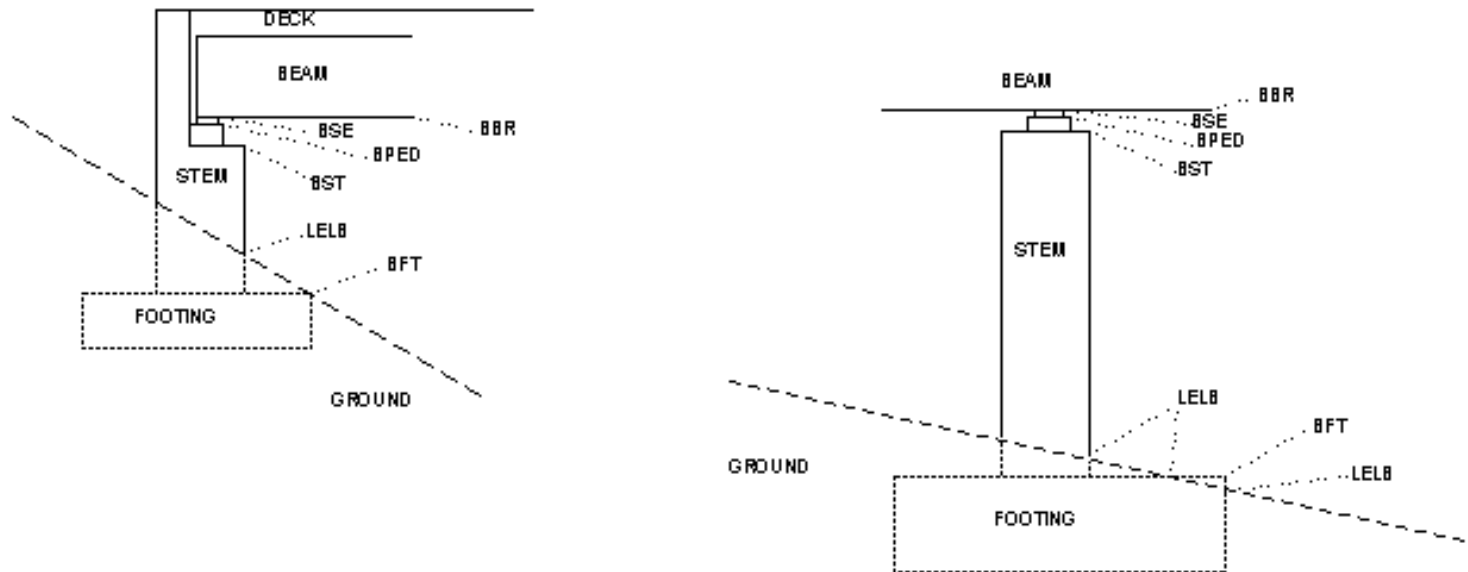

BBR - BRIDGE, BEAM, ROLLED, DNC
BSE - BRIDGE, SEAT, Breakline
BPED - BRIDGE, PEDESTAL, Breakline
BST - BRIDGE, STEM, Breakline
LELB - LANDSCAPE, ELEVATION BREAKLINE, Breakline
BFT - BRIDGE, FOOTING, Breakline

TERRAIN DATA (TOPOGRAPHIC) SURVEYS

11.4.3 DTM Procedures

DTMs provided for use on capital projects shall be in InRoads DTM format according to NYSDOT CADD [Software Standards](#) and the [CADD Standards and Procedure Manual](#).

A breakline method of DTM data collection (identifying elevation breaklines to trap triangulation into shapes which best define a triangulated terrain surface) shall be used.

General Terrain

When mapping the relevant natural and cultural features of a project site, the surveyor uses the procedures described in sections [11.4.1](#) and [11.4.2](#). Terrain is mapped as a combination of 3D lines (*breaklines*), and individual points (*random points*).

DTM Feature Types

Breaklines are 3 dimensional lines. They depict a break or change in the surface being mapped. This break is usually a change in the slope of the surface. Representations of the crest of a ridge, the edge or bottom of a ditch, the top of a curb or the foundation of a building are all examples of breaklines.

Breaklines also can define a change or break in the surface condition. Examples of these breaklines are the edge of a pond (surface changes from ground to water), the line between pavement and gravel, or the line between grass and concrete.

Breaklines are not contours; they do not necessarily follow a single elevation. They follow, instead, an actual and identifiable physical boundary at its true elevations.

Interior and exterior breaklines can exclude triangulation inside or outside of the feature.

Individual or *random points* also may be used to define terrain features. These shots may define things that exist at a point rather than along a line. Trees, fire hydrants and signs are all examples. Separate shots also may be used to capture special features or to record local high or low points where breaklines are not appropriate.

Features that do not represent the ground surface, included in the existing surface DTM, should have a DTM feature type of *DNC* (do not contour). The DNC DTM type will allow the feature to be viewed in the plan, cross section and profile views, but will not be incorporated in the triangulated network.

TERRAIN DATA (TOPOGRAPHIC) SURVEYS

Field Procedures

All existing point and line features shall be incorporated in the DTM with enough elevation breaklines and spot elevations so as to sufficiently define the DTM surface. Although all existing features shall be included in the DTM, some features may be excluded from the triangulated surface. Default DTM types are defined in the survey feature table as specified in NYSDOT [CADD Standards and Procedure Manual](#). The standard feature table, provided by the department, sets default DTM types for all existing features of Random, Breakline, Interior, Exterior, or Do Not Contour. Depending on the particular site some features may not be representative of the surface, and should either be field coded to exclude from triangulation; or the DTM surface features should be edited to change the DTM feature type so that the triangulated surface is representative of the existing surface.

Existing features shall be located as random points and breaklines depending upon whether locating a point or line feature. Line features are located as radial shots and connected as line features by using control coding such as ST to start a line, PC to start a curve, etc.

Line features shall be defined with enough surveyed points to sufficiently define the feature. Curved features shall have a sufficient number of data points and be measured so that the midpoint of any chord segment between two data points does not deviate from the actual curve. Breaklines measured around curves to portray a 3D feature shall have data points measured at closer intervals as the radius of the curve decreases.

Collecting Surface Data

Several rules shall be adhered to while collecting surface data. Accurate data collection is essential for producing accurate models. First, the correct spacing of random points and the correct placement of breaklines are critical to accurately modeling physical sites. The surveyor should collect random points at all local minima and maxima within a site. A local minimum or maximum is a location within the modeled site that is at a low or high elevation relative to neighboring points. Additionally, random points should be collected throughout the site so that the distance from one random point to another is about equal. Breakline data should be added to force the model to accurately represent areas where there are discontinuities in the terrain surface. Such features include the top and bottom of ditches, roadway crowns, and the edges of roadway pavement. Additionally, in certain circumstances where modeling areas include ridge or valley lines, add breaklines that follow these features. In general, breaklines should not cross one another. If breaklines cross, problems may be experienced triangulating the surface. Crossing breaklines should have the same elevation since a surface cannot contain two points at the same X,Y and have a different Z.

TERRAIN DATA (TOPOGRAPHIC) SURVEYS

The basic rule guiding the density, or frequency, of observed shots (breakline vertices) is to collect significant detail where it exists.

Generally, shots are taken at intervals of **25 ft. (10 m)** or less in areas of complex features or rapid vertical change. Shots are usually taken at **50ft. (20 m)** intervals along sections with little transition.

FIGURE XV. Shot Spacing Diagram

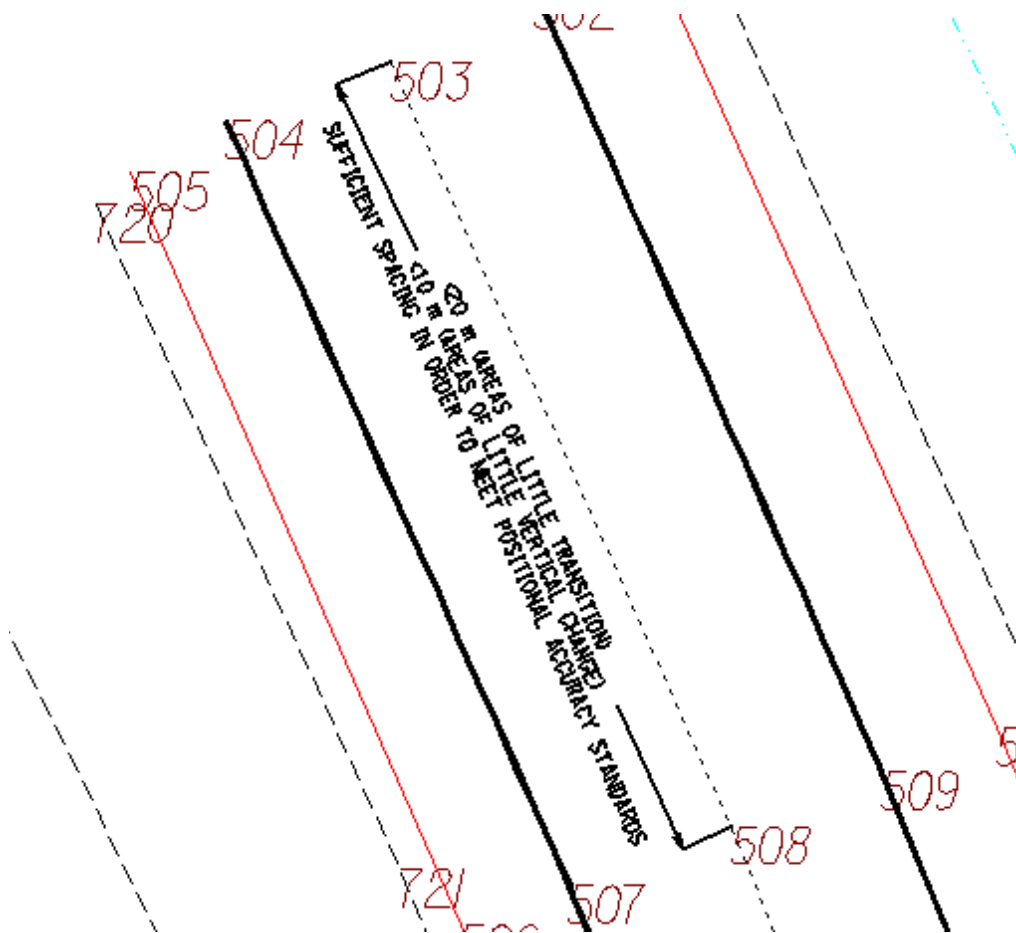

TERRAIN DATA (TOPOGRAPHIC) SURVEYS

Surveyed points that define line features should follow a cross section pattern. Using this method reduces the chance of crossing breaklines. This also provides a more uniform interpolation between actual surveyed points. Some of the software now being used offers templating procedures. This allows a rod person to take shots in a back and forth cross-sectioning fashion. Then, from these shots, breaklines are automatically constructed.

If a random point is included in the triangulated surface it may be necessary to take an additional cross section pattern at the random point, or locate an additional breakline feature to minimize the effect of the random point on the surrounding triangulation. This is most important if the random point is not representative of the surrounding surface.

FIGURE XVI. Cross Section Shot Pattern

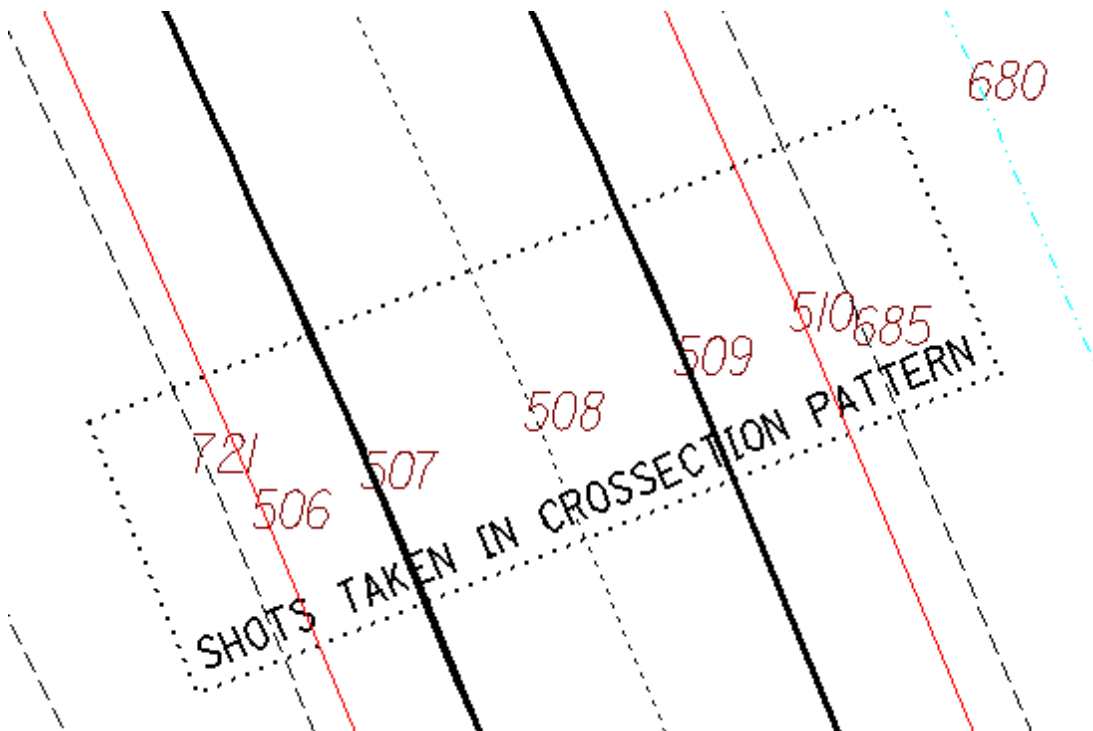

NYSDOT's highway design software does not recognize true vertical walls or features containing true vertical faces. The data measured at the top and bottom of these features shall be offset **no less than 0.10 ft. (30 mm)** from each other to correctly build the model. Such features are bridge abutments, retaining walls, curbs, etc.

Surfaces that define overhangs, bridge decks etc., shall be collected in a separate DTM.

TERRAIN DATA (TOPOGRAPHIC) SURVEYS

It is recommended that any photogrammetric control targets that fall within the survey DTM (SDTM) be measured and included as a random point in the DTM.

FEATURE DESCRIPTION

Specific 3D feature groups are described here for reference. All existing features shall be represented in the mapping, DTM and geometry. (Refer to the [CADD Standards and Procedure Manual](#) – Chapter 4, for more detailed feature lists)

Although all existing features shall be represented in the DTM not all features will be part of the triangulated surface. Whether or not a feature is included in the triangulated surface is controlled by the DTM type in the feature table. Surveyors should refer to the [CADD Standards and Procedure Manual](#) to determine default DTM types for these features and use their judgment as to whether to exclude any additional features from the triangulated network. Default DTM types can be overridden by the use of field coding or edited in the DTM surface.

Survey crews typically collect random points in a regular, grid-like fashion. Although the distance between these points vary from site to site, it would normally range from **15 ft. (5 m) to 150 ft. (50 m)** depending on the topography. To fine-tune the accuracy of the model, topographic measurements along lines where there is an obvious break in the terrain slope would also be collected. This second set of points would be added as breaklines. If there are certain areas on the site that need to be excluded from the model, such as, the footprints of large buildings, the survey crew would collect data points defining the perimeter of the area and add these to the model as interior boundary points.

Standard Feature Groups (Feature groups are stated in the [CADD Standards and Procedure Manual](#))

Bridge Feature Group

Bridge features shall be represented in the plan view and DTM as breaklines and random points. *Bridge Deck* features are set to a default DTM type of *Breakline* in the feature table. When processing a survey that includes a bridge deck, the bridge deck features shall be filtered and excluded from triangulation in the existing ground DTM. A bridge deck surface shall then be created by again filtering the bridge deck features and copying this portion of the DTM to a bridge deck surface. The bridge deck surface and the ground surface shall have points/lines in common at the bridge joint. Refer to [Bridge Survey](#) chapter of this manual for further guidance.

Control Feature Group

Shots on existing survey monumentation are included in the DTM, usually as DNC features. Shots should represent the top center of the survey monument (unless noted otherwise) and are usually not considered representative of the ground surface.

TERRAIN DATA (TOPOGRAPHIC) SURVEYS

Drainage Feature Group

Drainage features should be represented in the plan view and DTM as breaklines and random points. Drainage inverts are collected as random points. The invert point shall define the ends of the drainage channel breakline on either end of the culvert. The inverts shall be connected as a drainage culvert pipe feature if the surveyor can determine which connections exist. Drainage structures such as headwalls, wingwalls etc. are delineated in the plan view as the top of the feature. If exposed, the surveyor may locate the bottom of these features; otherwise, the surveyor shall locate the elevation breaklines or other features at the bottom face of these features. Drainage Structures shall be located at the top center of grate. If this elevation is not representative of the ground around the feature, additional breaklines should be collected around the feature.

Environmental Feature Group

Environmental features shall be included in the existing ground DTM surface. These features include all DTM feature types.

Geotech Feature Group

Geotech Drill Holes, have a default feature type of random. If these features are not representative of the existing ground surface they should be excluded from triangulation in the existing ground DTM surface.

Landscape Feature Group

The landscape feature group includes most features found outside of the roadway buffer. These features include all DTM feature types. The default feature types are set in the [CADD Standards and Procedure Manual](#), the surveyor may need to override certain random point features that may not represent the existing ground surface, by using the DNC control coding in the field or by editing the DTM feature type in the surface properties.

Mapping Feature Group

Mapping features are collected to assist in the determination of real property boundaries. When surveyed in the same data collection process as the terrain data they are included in the DTM, as DNC features. Shots should represent the top center of the feature (unless noted otherwise) and are usually not considered representative of the ground surface.

Pavement Feature Group (pavement crown, edge of travelway, pavement edge, curb, etc.)

Pavement features shall be represented in the plan view and the DTM as triangulated breaklines. Shots shall follow a cross section pattern. Spacing shall be sufficient to meet positional accuracy standards. Additional elevation breaklines, within the pavement, shall be collected in order to meet positional accuracy standards. Bottom of curb shall be located as **Pavement Edge**. Intersections of side roads with the main project alignment are areas that contain many breakline connections. Avoiding crossed breaklines in these areas is very important. The pavement crown of each side road should end at a point in common with the main alignment pavement features. Control coding should be used in the data collection that can join side road features to previously collected pavement features so as to eliminate duplicate surveyed points.

TERRAIN DATA (TOPOGRAPHIC) SURVEYS

Roadway Buffer Feature Group (guide rail, driveways, etc.)

Roadway buffer features such as curb, guiderail, driveways, etc shall be represented both in the plan view and the DTM as breaklines and point features. Roadway buffer features should be representative of the DTM surface. Roadway buffer features should normally be included in the triangulated network. Surveyors must make judgments as to excluding certain features that may not be representative or may negatively affect the triangulation. **Roadway Curb** should be located following the pavement shots cross section pattern, on the top of curb, towards the back, offset at least **0.10 ft. (30 mm)** horizontally from the **Pavement Edge**, in order to reduce the chance of crossing the **Pavement Edge feature**. Guide rail line features that may cross other features such as pavement edge should incorporate common points so as to eliminate the possibility of crossing segments. Guide Rail shots that are not representative of the surface can be excluded from triangulation by use of the DNC control coding or by editing the feature properties in the DTM surface.

Sign and Striping Feature Groups

These features should be represented in the plan view and DTM. These features are typically not representative of the ground surface and should, therefore, be excluded from the triangulated network.

Traffic Control Feature Group

These features should be represented in the plan view and DTM. Some features, such as loop detectors, may be representative of the DTM surface, while others such as control switches are not.

Utilities

These features should be represented in the plan view and DTM. They are usually not representative of the ground surface and should, therefore, be excluded from the triangulated network.

TERRAIN DATA (TOPOGRAPHIC) SURVEYS

11.5 DATA PROCESSING

A maximum segment length should be used in order to produce smaller triangles and force interpolation across features such as a pavement section rather than diagonal across the pavement. A setting of no maximum segment length, in areas of little transition, causes long triangle interpolations across the pavement and should be avoided.

FIGURE XVII. No maximum segment length

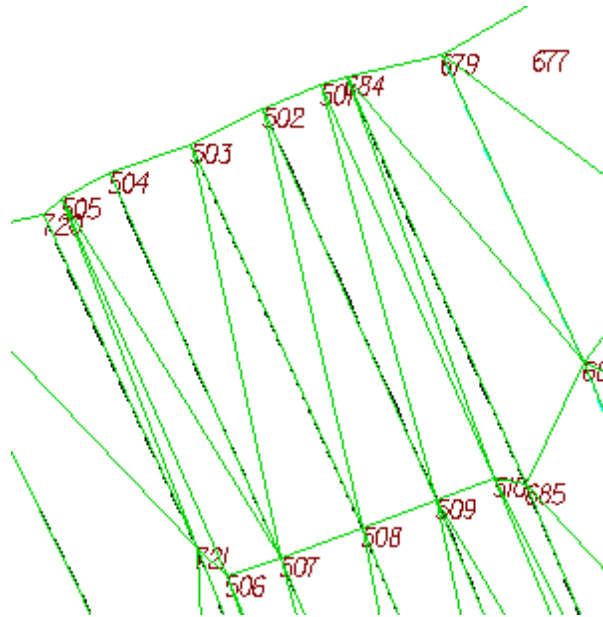

A maximum segment length of **10 ft. (3 m)** forces smaller triangles and directs interpolations across the pavement.

TERRAIN DATA (TOPOGRAPHIC) SURVEYS

FIGURE XVIII. Maximum segment length

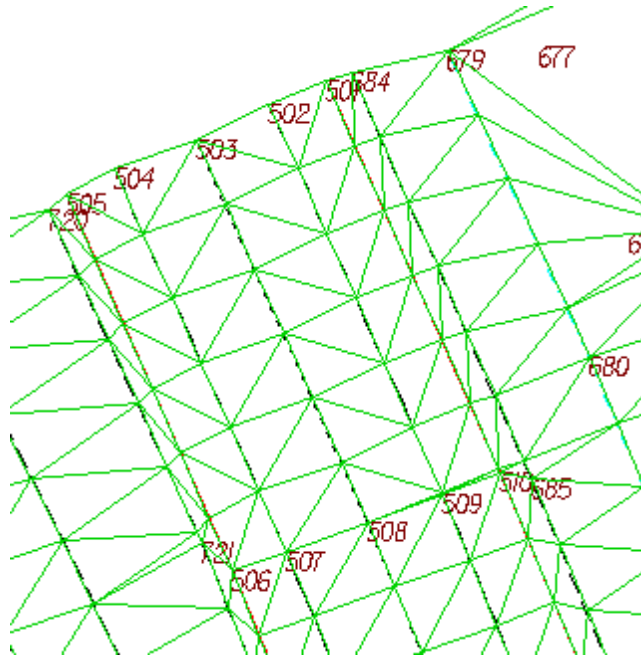

Segment Length should be set in the surface feature properties within InRoads.

11.6 MERGING DTMS

When collecting supplemental survey data for inclusion in an existing DTM surface, the accuracy of the existing DTM surface should be reviewed. DTMs collected by methods, other than the survey techniques described in this chapter, may have differing positional accuracies. Any difference in positional accuracies of the DTM surfaces will be merged between the two DTMs. Care should be taken to collect enough survey data, so that these merged areas are in areas not critical to design. Microstation design files, for any supplemental survey DTM data, shall be provided so that the end user can determine which DTM features were collected in the supplemental survey. Microstation graphics which represent DTM features shall include tags that define their source. Customers should be aware that the positional accuracies of these merged areas are only as accurate as the original DTM surfaces being merged.

11.7 FEATURE ATTRIBUTES

Features shall be described with attribute information as defined in the [CADD Standards and Procedure Manual](#). Attribute values should be included in survey, geometry, and DTM data.

TERRAIN DATA (TOPOGRAPHIC) SURVEYS

11.8 ADJUSTMENTS

All mapping, DTM, and COGO database points and lines shall be located from secondary project control. If secondary project control is adjusted, radial sideshots shall be recomputed from adjusted positions. Atmospheric corrections shall be applied at the instrument. Curvature and refraction corrections shall be applied in the processing. The project combined factor shall be applied to all slope distances.

11.9 SUPPLEMENTAL DTM DATA FOR PHOTOGRAMMETRY

This section defines a process for data measurement, file preparation, and product delivery of three dimensional (3D) survey data to the department's Photogrammetry Section for use in building digital terrain models (DTMs).

Some NYSDOT highway and structures design projects (or specific areas within a project) require terrain data with greater accuracies than can be provided through photogrammetric methods. For these projects, survey crews measure 3D data at these specific locations and send the data to the Photogrammetry Section. The survey data is combined with data measured photogrammetrically to produce a DTM for the subject project.

11.9.1 DEFINITIONS

Discrete (Random) Point - Elevation points measured at local peaks and depressions within the DTM.

Breakline - Typically a line segment used to delineate any visual change in the slope or aspect of a terrain feature.

Digital Terrain Model (DTM) - A DTM incorporates the elevations of discrete points and breaklines (i.e. edge of pavement (EOP), pavement crown, shoulder, and ditch.) These data can be measured by photogrammetric methods, survey methods or a combination of both.

Survey Digital Terrain Model (SDTM) - Breakline and discrete point data measured by regional or TASS survey crews using ground survey methods and instruments.

Photogrammetric Digital Terrain Model - Breakline and discrete point data directly measured using photogrammetric methods and instruments. Photogrammetric DTMs contain no interpolated data.

TERRAIN DATA (TOPOGRAPHIC) SURVEYS

11.9.2 APPROPRIATE AREAS FOR SDTM DATA

SDTM data combined with photogrammetric data provide accurate, cost-effective DTM surfaces, essential for project design and construction. However, DTMs for very small projects or projects located in highly urbanized areas may best be done entirely by ground survey. Utilizing totally photogrammetric methods may be best for other projects. For additional information please refer to the [Highway Design Manual- Chapter 5](#), Section 5.4. Terrain Data Requirements.

Measure SDTM data only in areas determined to be critical to the project. These areas would require greater vertical accuracies than possible using photogrammetric methods.

SDTM data may also be required in areas of obstruction and heavy shadows. The Photogrammetry Section will provide assistance in locating these areas by circling them on the control photos. The survey crew should discuss the locations of the obscure areas indicated on the photos with the project designer. This communication will help to decide whether the areas are critical and require measurement in the field. This process will only be used for projects that have significant obstructions.

11.9.3 DATA FILE INTEGRITY

Properly formatted SDTM data files are essential for timely, accurate DTM building.

The Regional Survey Supervisor shall provide edited SDTM data, regardless of measurement source (region or TASS), to the Photogrammetry Section.

Regional survey staff shall be responsible for the edit and review of SDTM feature content and portrayal. To help in the review, build a model with the SDTM data, utilize random cross sections and contours and run profiles on the pavement road crown and pavement edges to check for possible problems.

SDTM data files must meet file format and feature conventions stated the [CADD Standards and Procedure Manual](#).

11.9.4 SCHEDULE

Early delivery of SDTM data speeds photogrammetric data measurement and DTM building. The following steps are recommended guidelines for SDTM data delivery.

1. SDTM data should be submitted to the Photogrammetry Section no later than two (2) weeks after control survey delivery.
2. SDTM data submitted on time, but found to have problems, will be returned to the Regional Survey Supervisor for corrections. A problem report will be included in the package returned to the region. Resubmissions of SDTM data by the Regional Survey Supervisor must be received before the start of stereocompilation.
3. Late SDTM data will result in rescheduling of the project considering the requested mapping completion date, the Photogrammetry Section's schedule, and regional priorities.

TERRAIN DATA (TOPOGRAPHIC) SURVEYS

4. SDTM data submitted after the completion of the project can not be included in the DTM surface by the Photogrammetry Section. The Photogrammetry Section provides 3D design files to the region for their use. Regional staff will be responsible for combining the two data files.

11.10 QUALITY CONTROL

The Geometry, Mapping and DTM should be checked to assure the standards and procedures in this chapter have been followed and finished products meet the requirements stated in the [CADD Standards and Procedure Manual](#).

11.11 SURVEY RECORDS

11.11.1 FIELD NOTES

Field notes including raw observations, feature coding, control coding, and attribute information shall be submitted for each Terrain Data survey in ascii.txt format.

11.12 REFERENCES

[Highway Design Manual](#)
[CADD Standards and Procedure Manual](#)

12. RIGHT OF WAY (ROW) MAPPING SURVEYS

RIGHT OF WAY (ROW) MAPPING SURVEYS

12.1 INTRODUCTION

The purpose of this chapter is to set standards and provide guidance for ROW Mapping Survey procedures and policies as they relate to locating field and record evidence that could be used in the determination of existing property line and highway boundary locations.

The objectives of the chapter are to provide Department employees, consultant surveyors, and designers with a standardized format to follow when locating property line and highway boundary field evidence that could be used to determine the locations of property lines and highway boundaries.

Existing ROW and Property Line Field Evidence shall be collected from a secondary project control baseline using radial surveying techniques. Coordinates for all existing evidence collected by survey shall be consistent with the [project coordinate system and datum](#).

ROW Mapping survey data may be collected in the same data collection process as the terrain data survey.

ROW Mapping Survey data should be collected using automated data collection procedures, incorporating automated mapping control coding and [NYS DOT feature coding](#). The ROW features shall be collected in the same survey data collection process using standard feature naming stated in the [CADD Standards and Procedure Manual](#). Mapping control coding shall control automatic 3d line generation.

When situations not addressed in this chapter arise or if an interpretation of the various procedures is needed contact [NYS DOT's Regional Land Surveyor](#) for assistance.

12.2 MINIMUM STANDARDS

All property line and highway boundary field evidence for ROW Surveys shall be located directly from secondary project control using a Total Station Positioning System (TPS) and radial surveying techniques. An exception being field evidence that is in a location not visible from the secondary project control, in these instances an alternative method will need to be chosen to locate the field evidence. These various methods are described in [Section 12.4.2.3](#) below.

12.2.1 Point Feature Accuracy Standards

Point feature accuracies are dependent upon how definable the evidence is and vary depending upon the type of evidence. For example the location of a real property marker is more definitive than the center of stone wall or fence line. Expected linear feature accuracies are shown in [Appendix 17.2](#).

12.2.2 Linear Feature Accuracy Standards

Linear feature alignments are created by the surveyor using mapping control coding. Linear feature alignment accuracies are not only dependent upon point feature accuracies, but also point feature spacing/frequency, and alignment type (curve or linear). Expected linear feature accuracies are shown in [Appendix 17.2](#).

RIGHT OF WAY (ROW) MAPPING SURVEYS

12.3 FIELD RESEARCH

After the written evidence has been researched, reading through the title reference will be helpful. Mark on the relative Tax Maps the locations of any noted property evidence for use in locating the property evidence during the field research. Information obtained should be verified on the ground. Ground checks are made for possible gaps, overlaps and discrepancies in the survey data that would have an effect on the ROW. A diligent search shall be made to find all private property monuments and ROW monuments that fall within, abut or impact the area of highway construction or reconstruction. The inclusion of all necessary land corners for legal land ties is of utmost importance. It is helpful to have aerial photography, quadrangle maps, and labeled tax maps, as described above, to assist with the field research.

12.3.1 Verification of Record Evidence

The first phase of field research should be the location of known monuments that do exist. Such monuments are based on records that they do exist subject to local changes that might indicate that the monument has been destroyed, e.g., deep road excavation after the date the record evidence was collected. The following steps should be taken:

- a. Check of reference ties: If there are reference ties on record for the land corners, they should be checked. Any major difference in distance for these ties to a monument should be noted. It is important that no new ties be added to the same trees, poles, etc. that are already being used for a reference tie as this may lead to confusion at a later date.
- b. Magnetic locator: The magnetic locator affords a very quick and efficient means of locating ferrous metallic monuments. For example, one tie could be used in combination with the locator and the point found. At this time the other existing ties should be checked.
- c. Excavation. If not readily visible, the monument marking the land corner or ROW may have been covered by dirt or by a roadway. In this case, you should search an area large enough, and within **3 ft. (a meter)** of the surface of the ground, that leaves no doubt that a monument is existing. Existing construction plans of the area should be researched to determine if the area is in a "cut" or "fill" area. In looking for a monument it will suffice most of the time to excavate with a shovel. In developed areas, neatly replace the sod when finished.

RIGHT OF WAY (ROW) MAPPING SURVEYS

12.3.2 Interviews of Property Owners & Local Residents

Before any interview with a property owner or local resident is attempted, the interviewer should become knowledgeable in the extent of the project and the approximate dates of various phases of the planned construction. The interviewer should also understand the limits on information he/she can give. In cases regarding specific questions relative to areas outside of surveying, the interviewer should indicate whom the question should be referred to. The following steps are a guide to establish a business format for the interview.

a. Prepare a comprehensive list of questions before the date of the interview. The following are samples of frequently asked questions:

1. How many years have you lived in the area?
2. How many years have you owned or occupied this property?
3. How long has a specific improvement (road, fence, building) existed?
4. Did the improvement in Item 3 replace a previous improvement? If so, when?
5. Was either, old or present, improvement placed by a survey? If yes, find out by whom and when. Ask if you could see any survey map they might have.
6. Do you have knowledge of your property corners? Would you help me locate the monuments?
7. Have there been property disputes, feuds, or legal proceedings over property boundaries in the vicinity?
8. Do you have knowledge of the location of any ROW monuments in the area?
9. Where are the locations of any wells (used or unused) within 20 ft. of the ROW?

b. Introduce yourself: Give your name, title and office location. Have employee identification visible.

c. Inform the interviewee of:

1. The project you are working on.
2. The nature of the project.
3. The information needed.
4. Arrange for a convenient time to return if more information is needed.

d. Interview:

During the interview make short written notes of names, dates and significant facts. Upon completion of the interview write neat and complete notes.

12.3.3 Search for Unrecorded Monuments

a. Magnetic Locator: A search should be made at road intersections, fence intersections, etc. for possible monuments even if there is no record evidence available. When such monuments are found they may have registration numbers or other identifiable characteristics that may lead to their origin.

b. Excavation. No excavation should be done at random. If a reading registers on a magnetic locator some digging should be done. If extensive excavation is involved it should be done after all evidence has been analyzed.

RIGHT OF WAY (ROW) MAPPING SURVEYS

12.3.4 Monument Perpetuation

Where the highway ROW takes partial lots or tracts, the position of the old corner monuments is crucial to private surveyors for future location of property lines. The block and lot corner monuments of subdivision plats may be the only evidence by which the correct corner monument can be reestablished. A record of all monuments found shall be kept in the survey report as to the type, size, and registration number of the surveyor who set the monument if known. All found monuments shall have their position perpetuated by making ties to the control survey. Include the date of recovery and the coordinates of the monuments in the survey report for future reference.

12.3.5 Analysis

Reconstructing boundary corner locations from written, survey, parole, and physical evidence requires considerable care and judgment. Generally the analysis should result in a reconstruction of the original survey or a "following in the footsteps of the original surveyor". NYSDOT does not certify that found monuments mark the correct location of private boundary corners.

12.4 FIELD PROCEDURES

12.4.1 Point Feature Location Procedures

All point features for ROW surveys should be located directly from secondary project control using TPS and radial surveying techniques.

Shots should represent the top center of the survey monument (unless noted otherwise) and are usually not considered representative of the ground surface.

The total station used will be at least a five second least-reading instrument. The total station used should have a minimum DIN accuracy of five seconds (angle) and 0.010 ft. (2 mm) +2ppm (distance).

Automated data collection is typically required.

An example of the procedures typically used with automated data collection by NYSDOT is described below.

12.4.1.1 Set-up

Instrument is setup over an angle point in the project control line.

Atmospheric refraction corrections are set on the instrument.

Prism offset is accounted for in all distance measurements on the instrument.

The height of the backsight target and height of Instrument are measured and recorded.

The instrument is pointed at the backsight and the horizontal angle, the zenith angle and slope distance are recorded by the data collector.

The height of the reflector on the range pole is measured and entered. It is important to measure the actual target (rod) height and not rely on graduation marks.

RIGHT OF WAY (ROW) MAPPING SURVEYS

12.4.1.2 Operation

With the prism/target mounted on top, the rod-person sets the rod on the point to be measured and holds the rod plumb.

The instrument operator sights the pole-mounted prism/target with the total station.

On command, the total station measures the slope distance and horizontal and zenith angles to the point and sends the data to the data collector.

The operator enters mapping control coding, feature coding and attribute information.

This measurement operation continues until all relevant features have been mapped.

12.4.2 Radial Surveying Techniques

12.4.2.1 Existing Feature (well defined)

When locating well defined features such as Highway Boundary and Property Line evidence, care should be used in order to achieve the positional accuracies specified above.

Highway boundary and property line evidence shall be located from a secondary project control traverse using radial surveying methods. Location of government and private survey monuments and Real Property Monuments should be located using some form of redundant measurements either by location from two different secondary project control stations or by collecting multiple observation sets.

A properly adjusted Prism Pole Rod with target shall be used.

A bipod can be used.

12.4.2.2 Existing Feature (marginally defined)

When locating marginally defined features such as, Bent Iron Pipes, Stone Walls, Fence Lines, Tree Lines...ect. a standard of care should be used in order to achieve the positional accuracies specified above.

A properly adjusted Prism Pole Rod with target shall be used.

Care should be taken so that the prism pole is positioned in order to meet positional accuracy standards.

RIGHT OF WAY (ROW) MAPPING SURVEYS

12.4.2.3 Side Traverses

When property line evidence and topography is obscured from the secondary project control traverse, there may be a need to establish a side traverse to be able to locate the evidence.

Effort should be made to close side traverses on another secondary project control station using secondary project control standards and procedures, if practical. Otherwise, side traverses should be minimized to no more than two stations and some form of redundancy should be incorporated into the traverse such as locating common points from multiple traverse stations and/or collecting multiple observation sets from each station.

From an angle point in the side traverse you could locate such features as back corners of property lines (if needed), fence lines, tree lines, stone walls, wells, septic systems, structures ... etc.

The procedure for creating a side traverse is as follows:

Observe temperature and atmospheric pressure and enter this data into the total station to correct the slope distance for atmospheric affects.

Account for prism offset in all distance measurements in the instrument settings.

A backsight of known azimuth should be used. Backsight and foresight targets should be tripod mounted.

Measure horizontal angles two times in sets of direct and reverse attitudes (2 D&R). The suggested procedure is to:

1. sight the backsight with telescope direct
2. turn the angle right to the foresight
3. plunge the telescope and re-sight the foresight with the scope reversed
4. turn the angle right to the backsight

This is one D&R.

The sum of the direct and reversed horizontal angles of a single set of angles should not deviate from 360° by more than 5.0 seconds. Re-observe, rejecting sets, until the two sets agree within this tolerance.

For total station instruments that include the capability, the vertical indexing initialization procedure should be checked at the beginning of each day.

Measure zenith angles used to reduce slope distance to its horizontal component in both the direct and reversed attitudes.

The sum of the direct and reversed zenith angles of a single set of angles should not deviate from 360° by more than 10.0 seconds. Observe, once again, the rejected sets until the two sets agree within this tolerance.

RIGHT OF WAY (ROW) MAPPING SURVEYS

Measure all baseline distances electronically from both ends of each line.

The slope distances (between adjacent control points) from forward and backward measurements should not differ by more than the amount that the precision of the EDM device predicts.

For locating points from the side traverse set up the total station on an angle point in the side traverse and follow the procedures describes in Sections [12.4.1.1](#) and [12.4.1.2](#) above.

12.4.3 Linear Feature Location Procedures

Linear features shall be created from Point features for all existing linear features. Surveyors should use mapping control coding in order to store point features into an alignment definition. Sufficient point density should be gathered in order to meet the positional accuracy standards as specified above in section [12.2.2](#)

12.5 SURVEY RECORDS

12.5.1 Research Records

Any reference materials such as deeds, map computations, survey notes, and base plots of property deeds, used for the ROW survey, shall be provided to the Regional ROW Mapping group. The material to be presented could include the following:

- A. A booklet or file containing deeds, cited easements, survey maps, and highway boundary and property line information necessary for the project. The booklet or files will have a separate section for each property owner and organized according to the tax map number. The booklet will include:
 - A Table of Contents itemizing material in the booklet or file.
 - Copies of all relevant Tax Maps
 - Sections containing the following information:
 - 1. appropriate deeds and cited easements
 - 2. copies of any available survey maps related to the property
 - list of coordinates corresponding to all the point numbers used on the project plan to show ROW monuments, iron pins and other property line documentation.
- B. A Tax Map showing the location and point numbers used for ROW monuments, iron pipes, and other property line documentation.

RIGHT OF WAY (ROW) MAPPING SURVEYS

12.5.2 Field Notes

Field notes including raw observations, feature coding, control coding, and attribute information shall be submitted to the Regional Land Surveyor for each ROW Mapping survey in ascii.txt format.

12.6 REFERENCES

NYS DOT [ROW Mapping Procedure Manual](#)

13. BRIDGE AND HYDRAULIC SURVEYS

BRIDGE AND HYDRAULIC SURVEYS

13.1 BRIDGE LOCATION REQUIREMENTS

13.1.1 Types of Bridge Projects

Field survey requirements for bridges will depend on the anticipated scope of work for the bridge. Projects involving bridge work include new, replacement and rehabilitation. Major rehabilitation such as bridge widening, deck replacement or major reconfiguration of the bridge will have different and more extensive survey requirements. Section 5.4 of the [HDM](#) should be referred to for additional survey needed to meet the terrain data requirements for the particular type(s) of bridge work anticipated for the project.

13.1.2 New and Replacement Bridges

New Bridges

Survey requirements for bridges on new alignments, where the proposed structure does not require ties with existing structural elements and/or existing highway features will only need to meet the terrain data requirements of Section 5.4 of the HDM.

13.1.3 Replacement Bridges

There are generally two types of replacement bridges.

1. Replacement at the same general location, with traffic being detoured either at or off site.
2. Replacement at the same general location, with traffic being maintained at the site using stage construction.

Prior to any field survey, an attempt should be made to secure as-built plans for the existing bridge. These as-built plans should be verified in the field by survey. To insure that the designer will be able to adequately relate the existing geometry to the proposed geometry, the surveyor should precisely and redundantly tie the new baseline to the old baseline, existing centerline and the controlling features of the existing structure. The extreme limits of existing permanent bridge features that will be adjacent to new construction shall be located to verify possible physical conflicts during construction.

[Refer to Section 6.10 for information on datum transformations.](#)

The existing bridge plan (Figure XVI) and elevation(s) (Figures XVII) shown below depicts points on some typical bridge features which are important and are considered control points in pinning down the existing geometry of the bridge.

Additional survey will be required for replacement bridges utilizing stage construction as shown in the bridge section (Figure XVIII) to establish required dimensions needed for stage construction control. Additional survey will also be required for any project where channel work is being proposed and is described in items 32 and 33 of the Bridge Data Sheet Part 2 in Appendix 3B of the Bridge Manual.

Substructure components (e.g. abutments, walls, piers, columns and stems) should be located and defined at ground level with strings of individual shots. When record plans are not available, the work required will be substantial and the surveyor is provided with instructions unique to each situation.

BRIDGE AND HYDRAULIC SURVEYS

FIGURE XIX. Bridge Plan

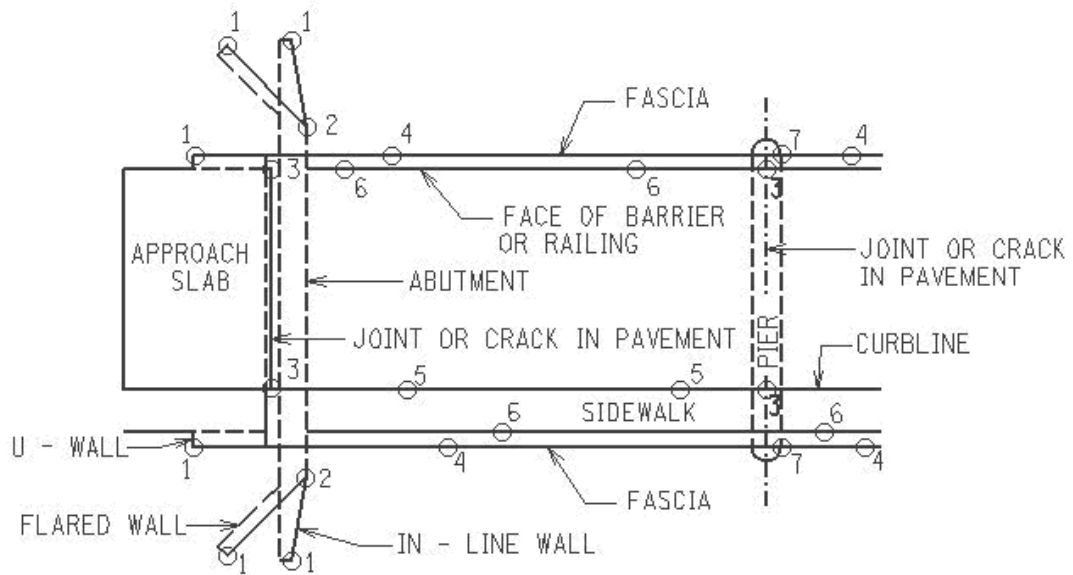

NOTE: SURVEY POINTS 4, 5 & 6 SHALL BE TAKEN AT 10 TO 20 m INCREMENTS TO CAPTURE THE NECESSARY LINE STRINGS.

BRIDGE AND HYDRAULIC SURVEYS

FIGURE XX. Bridge Abutment/Pier

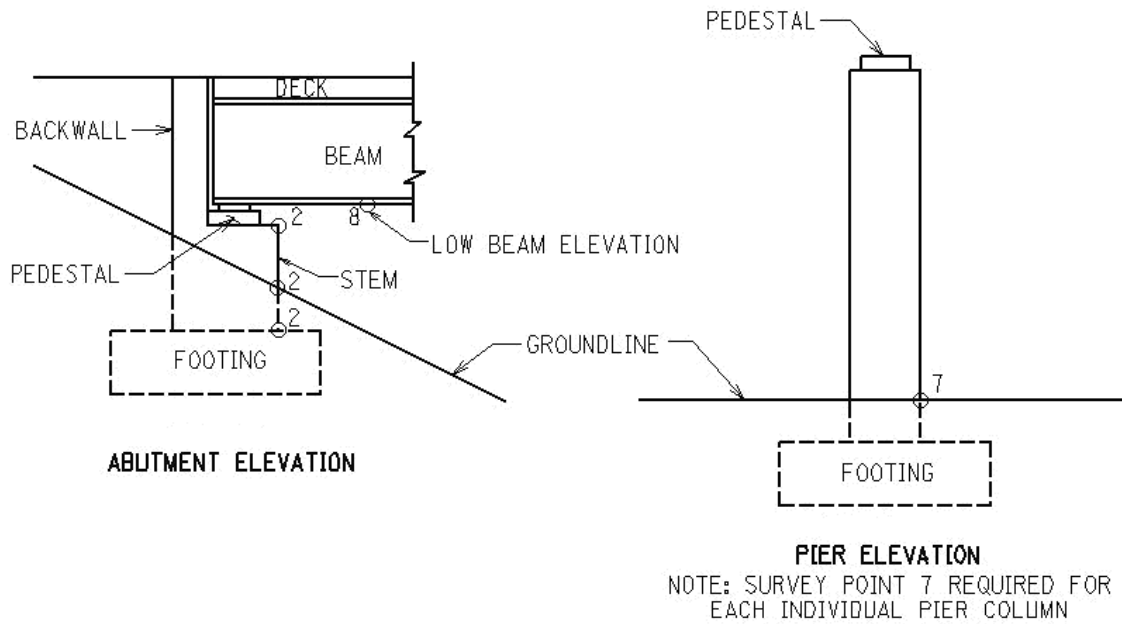
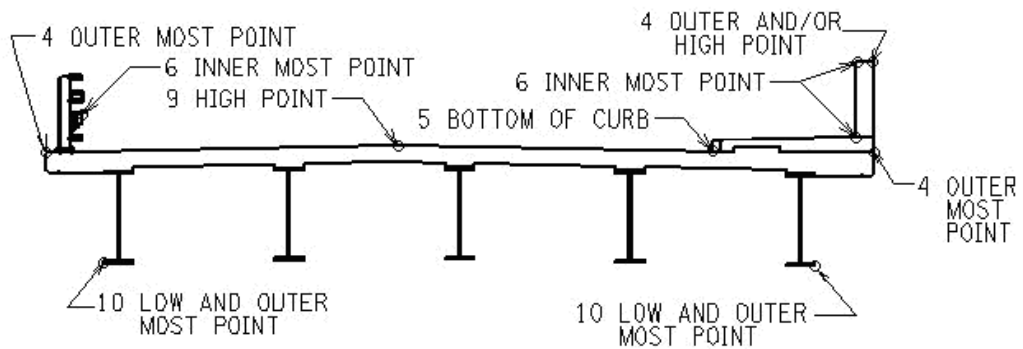

FIGURE XXI. Bridge Section



BRIDGE SECTION

NOTE: SURVEY POINTS SHOULD ALSO BE TAKEN ALONG POR IF BRIDGE IS SUPERELEVATED OR IN TRANSITION

BRIDGE AND HYDRAULIC SURVEYS

13.2 WATERWAY HYDRAULIC REQUIREMENTS

13.2.1 Introduction

It is important for the surveyor to determine the input file format required by the bridge program before entering data into the system. For example, when hydraulic cross sections are required for a stream flowing under a proposed bridge, cross sections need to be taken at the positions indicated below.

As an alternative to the very time-consuming laying-out of a precise cross section, a total station can be used to measure a single profile across a stream at the location of the needed cross section.

13.2.2 Site Data

The research required to collect the site information necessary to complete the bridge data sheets 1 & 2 is performed by the hydraulics engineer and incorporated into the bridge data sheets BD 124-1a and BD 124-2a and submitted along with any hydraulic information obtained from the bridge inspection report. The hydraulics engineer may request survey to collect the following site data.

Sections should be taken perpendicular to the direction of flow at design high water and at low flow. This may require a dog-leg shape section where the low flow channel meanders through the flood plain. The cross sections required for the hydraulic analysis of each structure should be taken as follows:

1. For bridge replacement projects, sections should be taken at both the upstream and downstream faces of the existing bridge, including elevations of the low chord, top of road, faces of piers and abutments. Sections should also be taken at upstream and downstream faces as stated above for any bridges within the limits of all the cross sections as listed below.
2. For all stream bridges, sections should be taken downstream from the proposed bridge location at the following approximate distances: **100 ft. (30 m); 200 ft. (60 m); 300 ft. (90 m); 400 ft. (120 m); 500 ft. (150 m); 1000 ft. (300 m); 2000 ft. (600 m). For streams with slopes flatter than 1 foot (0.3 m) in 1000 feet (300 m), an additional section should be taken 4000 ft. (1200 m) downstream.**
3. For all stream bridges, sections should be taken upstream from the proposed bridge location at the following approximate distances: a distance equal to the length of the proposed bridge; that length plus **100 ft. (30 m)**; that length plus **200 ft. (60 m)** and one at a bridge length plus **500 ft. (150 m)**. In cases where the bridge length exceeds **1000 ft. (300 m)** the bridge hydraulic design unit shall be contacted for a recommendation for the locations of the sections.
4. Additional cross sections should be taken at points where the characteristics of the terrain change radically, where the flow is constricted, where the shape of the channel changes, at sharp bends in the stream, at dramatic changes in the profile of the stream flow, etc. Contact the Regional Hydraulic Engineer or Main Office Hydraulic Unit for information

BRIDGE AND HYDRAULIC SURVEYS

5. Sections should be at least 7 times the width of the low flow channel, and if possible, as wide as the 100 year flood plain. In cases where the flood plain is very wide, shots should be taken as far away from the stream bank as practical.
6. If a special feature such as a lake or dam exists within 10 miles (16 km) downstream from the bridge site, this should be brought to the attention of the Main Office Hydraulic Unit to see whether additional sections may be required.
7. Cross sections should be reported in an ascii text file, listed from left to right looking downstream, starting with the farthest downstream section.
8. If a DTM generated from photogrammetry has been used to generate cross-sections electronically, these sections must be supplemented by survey crossing the stream at the cross-section locations to pick up the stream bed elevations below the water surface.

13.2.3 Cross Sections Required for Scour Susceptibility Study

1. The following cross sections should be taken along the stream baseline progressing from upstream to downstream. Cross-section elevations shall be in the USGS Datum.
2. A section at the upstream and downstream face of the bridge, including any piers or abutments that may be inside the face, within 3 feet (**a meter**) of the facia. This section should be taken along the face of the bridge even though this may not be perpendicular to flow. However, an estimate of the angle between the flow and the face of the bridge should also be included.
3. A section about 500 **ft. (150 m)** downstream of the bridge should be taken perpendicular to flow. It should be a full valley section to the estimated high water line and should be what the Surveyor considers a typical section. The distances between that section and the downstream face of the bridge should also be given; if it is around a curve of the river the distances of the right and left overbank should also be given to the downstream face of the bridge.
4. Another section **200 ft. (60 m)** downstream of the downstream bridge face, also taken perpendicular to flow and similar to the above section.
5. Sections perpendicular to the flow should be taken approximately one bridge length and one bridge length plus **100 ft. (30 m)** upstream of the bridge. These should be full valley sections to whatever extent the flow is during an extreme flood. If they are around a bend in the curve, the distances of the left and right overbanks should be determined.
6. Additional cross sections should be taken at points where the characteristics of the terrain change radically, where the flow is constricted, where the shape of the channel changes at sharp bends in the stream, etc. These sections should be taken perpendicular to the direction of flow at design high water and at low flow.

BRIDGE AND HYDRAULIC SURVEYS

7. Sections should be at least 7 times the width of the low flow channel, or if practical, they should be as wide as the 100 year flood plane. If the estimated high water is obviously within the stream banks, an elevation should be taken at the top of bank or at a location **10 ft. (3 m) +** vertically higher than estimated high water.
8. The elevation of a prominent point on the structure should be established, possibly the top of an existing wingwall. Also, the lowest bottom of beam elevation on the upstream facia should be determined.
9. Need stream section at end of wingwalls upstream and downstream.

13.2.4 Additional Information

The following information is also necessary in order to perform a hydraulic analysis. The hydraulics engineer may ask the regional survey group to provide some of this information. Submission of a MicroStation DGN file and an InRoads DTM file may be substituted in place of paper copies of this information required below in “a” through “d”:

- a) A small scale map showing the location and orientation of the cross sections.
- b) A **1:40 scale (1:250 metric)** map of the bridge area showing the existing topography.
- c) A cross-section of the proposed pavement section.
- d) A copy of the existing and proposed roadway profile.
- e) Copies of boring logs or information as to whether there is rock close to the channel bottom.

14. RAILROAD SURVEYS

RAILROAD SURVEYS

14.1 SAFETY

Railroad rights-of-way usually are not owned by the State. Field operations should be conducted in accordance with [3.4 Right of Entry](#). [Appendix 17.6](#) is a copy of a memo discussing the rights and responsibilities of NYSDOT surveyors and consultant surveyors engaged in NYSDOT projects. The regional survey manager will determine when flagging assistance from the railroad operator is necessary and appropriate.

14.2 PROCEDURES

Most railroad surveys conducted for the Department support the design for highway crossings. When substantial changes to a railroad's alignment need to be made, an extensive survey is required. When no changes need to be made to a railroad's alignment, however, there is no need for an extensive survey.

Depending on the requirements of the designer, the extent of the survey varies from fully defining all features within the railroad right-of-way to simply defining a short stretch of alignment. Generally, if a project involves track realignment, a railroad's horizontal alignment should be defined for about **1000 ft. (300 m)** beyond the anticipated project limits. Track profiles should be surveyed **1500 ft. (500 m)** beyond intersecting roadways.

The vertical control line or theoretical grade line is always the top of one of the rails. The horizontal control line is always the center line between rails or sets of rails. Points of switch and points of frog are also important in defining horizontal alignment. See diagram below.

A typical survey consists mostly of breaklines representing such features as both tops of rail, edge of ballast, toe of slope of ballast, edge of sub-ballast, toe of slope of embankment and/or centerline of ditch. The individual shots comprising these strings are taken at about **70 ft. (20 m)** intervals. Shots should be taken at shorter intervals on alignment curves and transitions or in areas of special interest.

15. CONSTRUCTION SURVEYS

CONSTRUCTION SURVEYS

15.1 RE-ESTABLISHMENT OF PROJECT CONTROL

The order of importance of project control is

- 1) Secondary Project Control Stations
- 2) Primary Project Control Stations
- 3) National Spatial Reference (NSRS) Stations

When Staking out Construction Projects Secondary Project Control stations should be used as control. If stations have been disturbed or removed, a control should be re-established between one existing secondary project control station pair and closed on another secondary project control pair, to [secondary project control standards and procedures](#).

If all secondary project control stations have been disturbed the primary project control should be used to re-establish secondary project control.

Secondary project control stations shall not be reset from ties.

15.2 ESTABLISHING PERMANENT SURVEY MARKERS (PSM'S) AND ROW MARKERS

PSM's and ROW Markers should be established from secondary or primary project control stations according to NYSDOT Standards and Specifications, Construction and Materials, [section 625](#), Right of Way Markers and [section 626](#), Survey Markers.

15.3 CORRECTIONS AND ADJUSTMENTS

NYSDOT Surveys are reported on the NYS Plane Coordinate System (NYSPCS) of 1983. Refer to [Chapter 6](#) for a description of the NYSPCS, datums, transformations and conversions.

When staking out construction projects using TPS technology the inverse of the [combined factor](#) (1/combined factor), also referred to as an output scale factor, shall be applied to all distances. This will scale the distance back to the position and elevation of the project. Stakeout distances should be limited to **650 ft. (200 meters)**.

When staking out construction projects using GPS technology the stakeout coordinates shall be projected to the position and elevation of the project.

15.4 CONSTRUCTION STAKEOUT

Proposed design data should be staked out directly from secondary or primary control stations using Levelling, TPS or GPS technology. If additional secondary control stations are needed they should be surveyed to [secondary project control standards and procedures](#).

CONSTRUCTION SURVEYS

When staking out construction features the construction survey must verify consistency with the secondary project control. If secondary project control has been disturbed the survey must verify consistency with primary project control.

When staking out construction features from the NYSNet CORS/RTN using RTK GPS methods the construction survey must verify consistency with the secondary project control. If secondary project control has been disturbed the survey must verify consistency with primary project control.

All survey equipment, including tripods, tribrachs, prisms, etc. shall be properly maintained and calibrated frequently according to manufacturers' guidelines. The National Geodetic Survey (NGS) calibration baselines established specifically for the checking of Electronic Distance Measuring Instruments (EDMI) may be used for checking the calibration of EDM's. Equipment calibration records and reports (not exceeding one year) shall be maintained by the surveyor and submitted to the Department as requested.

<http://www.ngs.noaa.gov/CBLINES/BASELINES/ny>

Construction Stakeout should be performed according to NYSDOT Standards and Specifications, Construction and Materials, [section 105-10](#), Stakeout.

16. FIELD EDITS OF PHOTOGRAMMETRIC MAPPING

FIELD EDITS OF PHOTOGRAMMETRIC MAPPING

Photogrammetric mapping methods cannot capture all of the information requested by design about the existing situation in a project area. Photo mapping only can capture every feature visible from a vantage point of about **1500 ft. (450 m)** straight up. When something can't be seen from that vantage point, it won't appear in the photo mapping products. An object may not be visible either because it is too small, is hidden by another object, or is at the wrong angle relative to the viewer. In any case, a person on the ground shall supply the remaining needed information. This activity generally is referred to as field editing.

Field editing is a process of collecting information to satisfy a requirement. The requirement is determined by the use to which the mapping will be put. It is key to determining what information shall be gathered and how precisely any measurements shall be made. Two types of data collection processes could be involved: 1. observation and annotation and 2. Conventional surveying. Typical examples of the kinds of information collected by observation and annotation are sign texts, utility identifications, and materials identifications. In addition, it often is necessary to *fill in* feature and topographic information missing from the photo map because it was obscured from the view of the camera. Radial surveying methods are commonly employed to acquire the needed details.

Field editing procedures can be applied to a project either before or after photogrammetric base mapping is delivered. The most common practice is to take copies of the base mapping to the project site and add any needed information that isn't depicted. The advantage of this *post mapping* approach is that the surveyors can see exactly what needed information is and isn't on the photo maps. They then can focus their efforts on getting exactly what they need. The disadvantage of this approach is that it can be applied only after the photo mapping has been delivered.

A time-saving alternative is to do the field editing work before the photo mapping is delivered. This can be done by using scaled enlargements of the aerial photographs printed on paper. These enlargements can be taken into the field and annotated with details not available from the photographs. The information is then available to be merged with the digital photo mapping files when they arrive. The advantage of this approach is flexibility. The field editing can be scheduled any time after the photos are available. The disadvantage is the additional cost of photo enlargements. However, this cost is small compared to the total cost of any capital project.

Substructure components — abutments, walls, piers, columns and stems — should be located and defined at ground level with strings of individual shots.

17. APPENDIX

APPENDIX

17.1 SURVEY CLASSIFICATIONS AND ACCURACY STANDARDS

NYS DOT ORDER	STANDARDS				PROCEDURES				APPLICATION --TYPICAL SURVEYS	
	LINEAR/PROPORTIONAL ACCURACY ⁴		POSITIONAL ACCURACY ^{6,7}		MONUMENT TYPE AND SPACING		TYPICAL SURVEY METHOD		HORIZONTAL	VERTICAL
	HORIZONTAL	VERTICAL	HORIZONTAL	VERTICAL	HORIZONTAL	VERTICAL	HORIZONTAL	VERTICAL		
Control Network Densification and Extension (Cooperative Base Network Surveys) ³	B-order 1:1,000,000	2nd-order maximum misclosure $e=0.03 \text{ ft. } \sqrt{D}$ ($e=8 \text{ mm } \sqrt{D}$)			3-D Rod, Disk in Massive Structure, or existing Bench mark (GPS'able) 15 Mile Average (25K Average)	3-D Rod, Disk in Massive Structure, 2 Mile Average (3K Average)	GPS: Static	Digital Level/Bar Code Rods	High Precision Geodetic Network (HPGN)	High Precision Geodetic Network (HPGN)
Primary Project Control – GPS Base Stations (User Densification Network)	C1 order 1:100,000	maximum misclosure $e=0.03 \text{ ft. } \sqrt{D}$ ($e=8 \text{ mm } \sqrt{D}$)			3-D Rod, Disk in Massive Structure, Feno Marker Within 4 Miles (7K) of project, in at least three quadrants.	3-D Rod, Disk in Massive Structure, Feno Marker Within 4 Miles (7K) of project, in at least three quadrants.	GPS: Static	GPS: Static Differential Leveling: Digital Level/Bar Code Rods Trigonometric Leveling: 1 sec least count Total Station	Primary Project Control: GPS Base Stations	Primary Project Control: GPS Base Station Elevations
Primary Project Control – GPS Azimuth Pairs (User Densification Network)	C2-I order 1:50,000	maximum misclosure $e=0.03 \text{ ft. } \sqrt{D}$ ($e=8 \text{ mm } \sqrt{D}$)			3-D Rod, Disk in Massive Structure, Feno Marker Azimuth Pairs: 2 Miles (3K) through project	3-D Rod, Disk in Massive Structure, Feno Marker Azimuth Pairs: 2 Miles (3K) through project	GPS: Static	GPS: Static Differential Leveling: Digital Level/Bar Code Rods Trigonometric Leveling: 1 sec least count Total Station	Primary Project Control: Azimuth Pairs	Primary Project Control: Azimuth Pair Elevations
Secondary Project Control	C2-II order 1:20,000	maximum misclosure $e=0.03 \text{ ft. } \sqrt{D}$ ($e=8 \text{ mm } \sqrt{D}$)			No. 5 Rebar with Cap Typical (Nails, Spikes, chiseled marks as required) Typical Spacing 1000 ft. (300 m)	As Required Bench mark Monument not subject to vertical movement. Typical Spacing 1000 ft. (300 m)	GPS: Static, Fast Static TPS: Single Route Traverse	Bench marks: Digital Level/Bar Code Rod Baseline Stations: Differential Leveling, GPS, Trigonometric Leveling	Secondary Project Control Survey Baseline Stations	Secondary Project Control Baseline Station Elevations, Bench marks
Photo Control	C2-II order 1:20,000	maximum misclosure $e=0.03 \text{ ft. } \sqrt{D}$ ($e=8 \text{ mm } \sqrt{D}$)			As Required	As Required	GPS: Static Fast Static Kinematic LRTK, NRTK TPS: Single Route Traverse, Multiple Sideshot, Multiple Observation	Level: Differential Leveling TPS: Trig GPS: Static, Fast Static, Kinematic	Photogrammetric Ground Control	
Terrain Data (Topographic) Feature Location	C3 order 1:10,000	maximum misclosure $e=0.05 \text{ ft. } \sqrt{D}$ ($e=12 \text{ mm } \sqrt{D}$)			Not Applicable	Not Applicable	TPS: Radial Sideshots from Secondary Project Control; GPS: NRTK; LRTK	TPS: Radial Sideshots from Secondary Project Control GPS: NRTK; LRTK	Terrain Data (Topographic) Survey Construction Stakeout Survey	
ROW Mapping Feature Location	C3 order 1:10,000	N/A			Not Applicable	Not Applicable	TPS: Multiple Sideshots from Secondary Project Control GPS: LRTK;NRTK	N/A	Right of Way Mapping Surveys Location of Real Property Monumentation	

APPENDIX

SURVEY CLASSIFICATIONS AND ACCURACY STANDARDS NOTES:

Notes:

1. The standards, specifications, and procedures included in this Survey Manual are based on the Federal Geodetic Control Subcommittee (FGCS) standards and specifications.
2. Refer to the relevant sections of the Manual for detailed procedural specifications for specific survey techniques and types of surveys.
3. Control Network Densification and Extension Surveys are performed to FGCS standards and specifications. Procedures shall be approved by NYSDOT and the National Geodetic Survey.
4. e = maximum misclosure in **hundredths of a foot** (mm in metric), D = distance in **Miles**.(Kilometers in metric)
5. TPS=Total Station Positioning System Techniques; GPS= Global Positioning System Techniques; Level=Differential Leveling Techniques
6. Network Accuracy: repeatability of connection to NAD83 or NAVD88 datum at 95% confidence level.
7. Local Accuracy: repeatability of station to station connections at 95% confidence level.

APPENDIX

17.2 VACANT

APPENDIX

17.3 HIGHWAY LAW, SECTION 30, PARAGRAPH 17

17. Notwithstanding the provisions of any general, special or local law, the commissioner of transportation, his officers, agents or contractor and the officers or agents of the United States when engaged on such highway projects, may, pursuant to section four hundred four of the eminent domain procedure law, enter upon property for the purpose of making surveys, test pits, test borings, or other investigations and also for temporary occupancy during construction. Claims for any damage caused by such entry, work or occupation not exceeding twenty-five hundred dollars may be adjusted by agreement by the commissioner of transportation with the owner of the property affected as determined by him by reasonable investigation without appropriating such property. Upon making any such adjustment and agreement, the commissioner of transportation shall deliver to the comptroller such agreement and a certificate stating the amount due such owner and the amount so fixed shall be paid out of the state treasury from monies appropriated for the acquisition of property for the project requiring such entry, work or occupation.

APPENDIX

17.4 EMINENT DOMAIN PROCEDURE LAW, SECTION 404

S 404. Right of entry prior to acquisition. The condemnor, its officers, agents or contractors when acquiring real property in accordance with this law, or when engaged in work connected with a proposed public project, as described in this law, shall have the right to enter upon any real property for the purpose of making surveys, test pits and borings, or other investigations, and also for temporary occupancy during construction. At a reasonable time prior to such entry, the condemnor shall deliver notice personally or by first class mail, to the property owner stating the necessity for the entry. The condemnor shall be liable to the owner for any damages caused by the condemnor as a result of the entry; but such damages shall not entail duplicate payment of damages to be compensated for by the condemnor pursuant to article three of this law. Entry damages, if any, shall not be deemed an acquisition.

APPENDIX

17.5 RIGHT OF ENTRY FORM HC 176

Dear Property Owner:

Re: Project #
County

The New York State Department of Transportation is engaged in planning and designing the above-mentioned highway improvement project. In order to advance this project, it will be necessary for members of this Department or their representatives to enter property within the design area for purposes of surveys and soil explorations. We find that this area contains property belonging to you.

This Department has the absolute legal right to enter your property for such purposes, pursuant to the authority of section 30, paragraph 17 of the New York State Highway Law. We understand that our entry onto your property may be disconcerting. Therefore, we wish to inform you in advance that we will be conducting preliminary surveys or tests that may require us to enter onto your property (identify dates or time frame). If that time is problematic for you, we will use our best efforts to coordinate with your scheduling needs.

If any damage is done to your property as a result of such entry, you are entitled to payment. The Department is authorized to pay claims directly for damages not exceeding \$ 2,500. For larger claims, the procedure set forth in section 10 of the Court of Claims Act for bringing an action against the State must be followed.

Please feel free to direct any questions you have in this matter to me. A copy of section 30, paragraph 17 of the Highway Law is attached for your information.

Very truly yours,

Regional Director

Attachment

HC 176-1c (2/95)

APPENDIX

Section 30, paragraph 17 reads as follows:

“Notwithstanding the provisions of any general, special or local law, the commissioner of transportation, his officers, agents or contractor and the officers or agents of the United States when engaged on such highway projects, may, pursuant to section four of the eminent domain procedure law, enter upon property for the purpose of making surveys, test pits, test borings, or other investigations and also for temporary occupancy during construction. Claims for any damage caused by such entry, work or occupation not exceeding twenty-five hundred dollars may be adjusted by agreement by the commissioner of transportation with the owner of the property affected as determined by him by reasonable investigation without appropriating such property. Upon making any such adjustment and agreement, the commissioner of transportation shall deliver to the comptroller such agreement and a certificate stating the amount due such owner and the amount so fixed shall be paid out of the state treasury from monies appropriated for the acquisition of property for the project requiring such entry, work or occupation.”

HC 176-2a (2/95)

APPENDIX

17.6 "SURVEYING ON RAILROAD PROPERTY" MEMO MEMORANDUM DEPARTMENT OF TRANSPORTATION

TO: R. C. Babyak, Regional Design Engineer, Region I

FROM: D. W. Harp, Asst. Commissioner, Legal Affairs, 5-505

SUBJECT: SURVEYING ON RAILROAD PROPERTY

DATE: August 3, 1993

cc: Regional Design Engineers
MO Design Bureau

This will reply to your memorandum of July 14, 1993 regarding the referenced subject (copy attached).

As you know, Highway Law, Section 30(17) provides "Notwithstanding the provisions of any general, special or local law, the commissioner of transportation, his officers, agents or contractor and the officers or agents of the United States when engaged on such highway projects, (projects enumerated in § 30(2)) may, pursuant to section four hundred four of the eminent domain procedure law, enter upon property for the purpose of making surveys, test pits, test borings, or other investigations and also for temporary occupancy during construction." (Underlining an parenthetical material added)

Section 404 of the Eminent Domain Procedure Law repeats the authority of the condemner to enter private property for the purposes and following the procedure therein set forth.

The authority being implemented in these e two statutes is the inherent power of the sovereign (State of New York) to utilize for a legitimate public purpose, all lands within its boundaries. As observed by the State's highest court, the right to take private property for public use is an inherent and unlimited attribute of sovereignty whose exercise may be governed by the legislature; Application of Mazzone, 281 N.Y. 139 (1939T; and that the power of eminent domain antedates state and federal Constitutions, and survived their adoption, subject only to restrictions that taking shall be for authorized public use and that just compensation be paid to the owner., Fifth Avenue Coach Lines, Inc. v. City of New York, 11 N.Y.2d 347 (1962).

APPENDIX

The right of entry for survey stems from and is as fundamental as the right to acquire private property.. The same court has also specifically upheld the right of the state to take property belonging to a common carrier engaged in interstate commerce, observing that the State's 11 ... purpose is to acquire part of the carrier's property in order to promote public health and safety.... 11 Hudson River R. Dist. v. F. J. & G. R.R. Co., 249 N.Y. 445 (1928).

In addition §115 of the Transportation Law provides that "The commissioner, or responsible engineers or inspectors duly authorized by him, shall have power to enter-in or upon and to inspect the property, ...and offices of any such companies ... (Common Carriers)" Transportation Law §115(2). (Parenthetical material added)

The Department has maintained that this language alone can also cover entry onto railroad property. Railroads are nowhere exempted from any of the referenced State's rights.

It is therefore the opinion of this office that railroad property is included in the property which the commissioner of Transportation may enter for legitimate public purposes pursuant to statutes implementing the State's inherent power of eminent domain. The aid of the State Police can be enlisted to enforce the State's right of entry, if necessary.

The foregoing should not be deemed to apply without flagging assistance from the railroads where necessary and appropriate. However, entry not made in close proximity to operating railroad tracks does not require flagging assistance.

JCD/11
JCD0407/File 22.38
Attachment

APPENDIX

17.7 DESCRIPTION OF TERMS

Azimuth	The horizontal angle reckoned clockwise from the meridian -- from north in highway surveying.
Backsight	The reference point from which horizontal angles are measured with a total station.
Bench Mark	The specific case of a vertical control point.
Consultant	A private surveying firm qualified under the laws of New York to practice land surveying and acting, under agreement, as an agent of NYSDOT.
Control	Any station for which position coordinates and/or elevation are already known, and from which the positions or elevations of unknown stations are determined.
CORS	Continuously Operating Reference Stations. Continuously operating GPS receivers that can be used for differential GPS applications. Part of the National CORS network and the National Spatial Reference System (NSRS), maintained by the National Geodetic Survey. The NYSDOT CORS are part of the NYS Spatial Reference Network (NYSNet).
Data Collector	Portable computer, usually sized to hold in one hand, which automatically records observations made with a total station.
Direct	The telescope of the total station is in its normal orientation relative to the supporting instrument trunions.
DOP	Dilution of Precision, DOP factor indicates the geometrical strength of the satellite constellation at the time of measurement. Standard terms in the case of GPS are PDOP (Position and Height), GDOP (Position and clock offset), HDOP (position), VDOP (height).
DTM	A digital terrain model (DTM) is a digital map representation of a topographic surface.
EDM	Electronic Distance Measuring.
Elevation	The vertical distance from a datum to a point on the earth's surface.

APPENDIX

Ellipsoid	A mathematical surface which approximates the shape of the earth. The reference ellipsoid for NAD 83 is GRS80.
Fast Static GPS	Static observation technique achieving minimum point occupation times through coordinated relocation of GPS receivers.
Features	A feature is a named set of points in a Digital Terrain Model (DTM).
Foresight	The station or location to which a horizontal angle (relative to the backsight), zenith angle, and distance are measured.
GEOID	The equipotential surface of the Earth's gravity field which best fits, in a least squares sense, global mean sea level.
Geospatial Data	Geographic data (land features) represented in a common reference system so that all data can be spatially related. The NYS Spatial Reference Network (NYSNet) CORS/RTN provides this common reference system for NYSDOT.
GPS	Global Positioning System. A US space based radionavigation system that provides reliable positioning, navigation, and timing services to civilian users on a continuous worldwide basis.
GLONASS	Global Navigation Satellite System (GLONASS). A Russian space based radionavigation system similar to GPS
GNSS	Global Navigation Satellite System (GNSS). International term used to describe all global satellite navigation systems. (GPS, GLONASS etc.)
HARN	High Accuracy Reference Network. This is a single horizontal network of GPS and VLBI stations based on the new continental network established by NGS.
Localization	localization (site calibration, transformation parameters, determine coordinate system) of project control is the process of determining transformation parameters from the GPS coordinate system (WGS84) to a local coordinate system or datum. Transformation parameters are determined by computing the shift, rotation and scale from the WGS 84 coordinate system to the local coordinate system. By surveying points known in the local coordinate system with GPS software can determine these transformation parameters.
HI	Height of Instrument. The vertical distance from the station mark to the center of the trunion axis of the total station or level.

APPENDIX

HT or HR	Height of Target (Reflector). The vertical distance from the station mark or the ground to the center of the object being sighted with the total station.
Kinematic GPS	Observation technique achieves shortest possible occupation time by continuously tracking satellites during movement between stations.
NAD 83	North American Datum of 1983. Horizontal reference datum which superseded NAD 27.
NAVD 88	North American Vertical Datum of 1988. Vertical reference datum which superseded NGVD 1929.
Network RTK	NRTK, use of a network of reference stations to model correction differences across the network. Correction differences can then be interpolated for the rover position in the network and applied to the RTK observations. NRTK can reduce the ppm error due to atmospheric differences allowing centimeter RTK positioning across the network.
NGS	National Geodetic Survey. The federal government activity responsible for national programs in geodesy and geodetic surveying. A Division under the National Ocean Service of the National Oceanic and Atmospheric Administration, within the Department of Commerce.
NGVD 29	National Geodetic Vertical Datum of 1929. Vertical reference datum.
NYSPCS	New York State Plane Coordinate System, Adopted by the NY State Legislature to authorize use of the State Plane Coordinate System of 1983 as defined by NGS.
NYSNet	New York State Spatial Reference Network, a spatial reference network of continuously operating Global Positioning System (GPS), reference stations (CORS) throughout NYS that can be used for differential GPS applications.
Orthometric Height	The distance between the geoid and a point measured along the plumb line and taken positive upward from the geoid
Post Processing	GPS observation data simultaneously collected by several receivers is returned to the office for differential correction processing and adjustment.
Photogrammetry	Photogrammetry is the art, science, and technology of obtaining spatial information about physical objects and the environment through the processes of recording, measuring, and interpreting

APPENDIX

photographic images and patterns of electromagnetic radiant energy and other phenomena.

Position	The coordinates, in a horizontal reference system, of station mark or feature. Latitude and longitude, and Northing and Easting are examples of position coordinates in systems used in surveying.
Real Time	GPS differential correction information is received and used to compute and display raw positions in the field as observations proceed.
Reverse	The telescope of the total station is "upside down" from its normal position relative to the supporting instrument trunions.
ROW	Right-of-Way. The strip or area of land around a state highway granted as easement or fee to the State and managed by NYSDOT.
RTK	Real Time Kinematic GPS, RTK is a process where GPS corrections are transmitted in real time from a reference receiver at a known location to one or more remote rover receivers
Single Base RTK	Use of a single reference station to apply differential corrections and achieve centimeter positioning. The accuracy of single base RTK diminishes as the distance from the reference station increases, usually by 1 ppm.
Static GPS	Observation technique having all receivers stationary at points on a fixed, pre-determined schedule.
Total Station	Electronic surveying instrument that combines angle and distance-measuring capabilities in a single unit.
TPS	Total Station Positioning System
WGS84	World Geodetic System of 1984. defined by the National Geospatial-Intelligence Agency (NGA). WGS 84 is the reference frame used in GPS.
Zenith Angle	The angle, measured in the vertical plane, between straight up (zero) and the target of observation. Horizontal is, therefore, 90 degrees.

APPENDIX

17.8 INDEX

A	E
APPENDIX	EQUIPMENT..... 4-27
DESCRIPTION OF TERMS 17-173	
SURVEY CLASSIFICATIONS AND	
ACCURACY STANDARDS CHART ... 17-163	
SURVEYING ON RAILROAD PROPERTY	
MEMO 17-171	
	F
	FIELD EDITS OF MAPPING 16-159
C	
CONFINED SPACES..... 2-19	
CONSTRUCTION SURVEYS	
CONSTRUCTION STAKEOUT 15-154	
CORRECTIONS AND ADJUSTMENTS ... 15-154	
ESTABLISHING PERMANENT SURVEY	
MARKERS (PSM'S) AND ROW MARKERS	
..... 15-154	
CONTROL NETWORK DENSIFICATION AND	
EXTENSION	
DATA PROCESSING 7-51	
DOCUMENTATION..... 7-51	
FIELD PROCEDURES 7-51	
HORIZONTAL GEODETIC CONTROL... 7-51	
VERTICAL GEODETIC CONTROL..... 7-51	
INTRODUCTION 7-48	
MINIMUM STANDARDS 7-50	
HORIZONTAL GEODETIC CONTROL	
STANDARDS 7-50	
VERTICAL GEODETIC CONTROL	
STANDARDS 7-50	
MONUMENTATION..... 7-50	
HORIZONTAL CONTROL STATION 7-50	
CORS 7-50	
VERTICAL CONTROL STATION 7-50	
QUALITY CONTROL 7-51	
REFERENCES 7-52	
COORDINATE SYSTEM..... 6-38	
COORDINATE SYSTEMS AND DATUMS	
COORDINATE SYSTEM 6-38	
DATUM TRANSFORMATIONS 6-44	
DISTANCE CONVERSIONS 6-44	
DOCUMENTATION..... 6-45	
HORIZONTAL DATUM 6-40	
INTRODUCTION 6-38	
REFERENCE SYSTEM 6-38	
REFERENCES 6-45	
UNITS OF LENGTH..... 6-42	
VERTICAL DATUM 6-42	
CREW COMPOSITION PERSONNEL AND	
EQUIPMENT	
EQUIPMENT 4-27	
PERSONNEL 4-27	
	H
	HORIZONTAL DATUM..... 6-40
	HYDRAULIC SURVEYS
	WATERWAY HYDRAULIC REQUIREMENTS
 13-148
	ADDITIONAL INFORMATION..... 13-150
	CROSS SECTIONS REQUIRED FOR SCOUR
	SUSCEPTIBILITY STUDY..... 13-149
	INTRODUCTION 13-148
	SITE DATA 13-148
	I
	INTERVIEWS OF PROPERTY OWNERS AND
	LOCAL RESIDENTS 12-137
	M
	MONUMENTATION..... 7-50
	HORIZONTAL CONTROL STATION..... 7-50
	VERTICAL CONTROL STATION..... 7-50
	P
	PERSONNEL..... 4-27
	PHOTOGRAMMETRIC CONTROL
	DATA PROCESSING..... 10-107
	HORIZONTAL 10-107
	GPS 10-107
	TPS 10-107
	VERTICAL 10-107
	DIFFERENTIAL LEVELING..... 10-107
	GPS 10-108
	TPS 10-108
	INTRODUCTION..... 10-97
	MINIMUM STANDARDS 10-98
	HORIZONTAL CONTROL
	GPS TECHNIQUES 10-98
	TPS TECHNIQUES 10-98
	VERTICAL CONTROL..... 10-98
	DIFFERENTIAL LEVELING
	TECHNIQUES 10-98
	GPS TECHNIQUES 10-99
	TPS TECHNIQUES 10-98
	MONUMENTATION 10-98
	PROCEDURES 10-99
	HORIZONTAL 10-99
D	
DATUM TRANSFORMATIONS..... 6-44	

APPENDIX

<p>TPS TECHNIQUES 10-104</p> <p>VERTICAL 10-106</p> <p style="padding-left: 20px;">DIFFERENTIAL LEVELING</p> <p style="padding-left: 40px;">TECHNIQUES 10-106</p> <p style="padding-left: 20px;">GPS TECHNIQUES 10-106</p> <p style="padding-left: 40px;">TPS TECHNIQUES 10-106</p> <p>QUALITY CONTROL 10-108</p> <p>REFERENCES 10-109</p> <p>REPORTING 10-108</p> <p style="padding-left: 20px;">CONTROL REPORTS 10-108</p> <p style="padding-left: 40px;">HORIZONTAL 10-109</p> <p style="padding-left: 40px;">VERTICAL 10-109</p> <p style="padding-left: 20px;">FIELD NOTES 10-108</p> <p style="padding-left: 40px;">HORIZONTAL 10-108</p> <p style="padding-left: 40px;">VERTICAL 10-108</p> <p>PRIMARY PROJECT CONTROL</p> <p style="padding-left: 20px;">DATA PROCESSING 8-69</p> <p style="padding-left: 40px;">HORIZONTAL 8-69</p> <p style="padding-left: 40px;">VERTICAL 8-71</p> <p style="padding-left: 60px;">DIFFERENTIAL LEVELING 8-71</p> <p style="padding-left: 60px;">GPS LEVELING 8-71</p> <p style="padding-left: 60px;">TRIGONOMETRIC LEVELING 8-71</p> <p style="padding-left: 20px;">INTRODUCTION 8-54</p> <p>MINIMUM STANDARDS 8-56</p> <p style="padding-left: 40px;">HORIZONTAL PROJECT CONTROL 8-56</p> <p style="padding-left: 40px;">VERTICAL PROJECT CONTROL 8-57</p> <p>MONUMENTATION 8-56</p> <p>PROCEDURES 8-57</p> <p style="padding-left: 40px;">HORIZONTAL PROJECT CONTROL 8-57</p> <p style="padding-left: 40px;">VERTICAL PROJECT CONTROL 8-65</p> <p style="padding-left: 60px;">DIFFERENTIAL LEVELING 8-65</p> <p style="padding-left: 60px;">TRIGONOMETRIC LEVELING 8-65</p> <p>QUALITY CONTROL: 8-73</p> <p>REFERENCES 8-77</p> <p>REPORTING 8-73</p> <p style="padding-left: 20px;">FIELD NOTES 8-73</p> <p style="padding-left: 40px;">HORIZONTAL 8-73</p> <p style="padding-left: 40px;">VERTICAL 8-73</p> <p>SURVEY REPORTS 8-73</p> <p style="padding-left: 20px;">HORIZONTAL(GPS SURVEY REPORT) 8-74</p> <p style="padding-left: 20px;">VERTICAL 8-75</p> <p>PROCEDURES 1-14</p> <p>PROJECT CONTROL <i>SEE UNDER PRIMARY PROJECT CONTROL AND SECONDARY PROJECT CONTROL</i></p> <p>PUBLIC RIGHTS AND NOTIFICATION</p> <p style="padding-left: 20px;">COURTESY 3-23</p> <p style="padding-left: 20px;">INTRODUCTION 3-23</p> <p style="padding-left: 20px;">RIGHT OF ENTRY 3-23</p> <p style="padding-left: 20px;">WHAT TO DIVULGE 3-23</p> <p>PURPOSE 1-13</p>	<p>RIGHT OF ENTRY 3-23</p> <p>RIGHT OF WAY SURVEYS</p> <p style="padding-left: 20px;">FIELD PROCEDURES 12-138</p> <p style="padding-left: 40px;">LINEAR FEATURE LOCATION 12-141</p> <p style="padding-left: 40px;">POINT FEATURE LOCATION 12-138</p> <p style="padding-left: 60px;">OPERATION 12-139</p> <p style="padding-left: 60px;">SET-UP 12-138</p> <p style="padding-left: 20px;">RADIAL SURVEYING TECHNIQUES 12-139</p> <p style="padding-left: 40px;">EXISTING FEATURE(MARGINALLY DEFINED) 12-139</p> <p style="padding-left: 40px;">EXISTING FEATURE(WELL DEFINED) 12-139</p> <p style="padding-left: 60px;">SIDE TRAVERSES 12-140</p> <p>FIELD RESEARCH 12-136</p> <p style="padding-left: 20px;">ANALYSIS 12-138</p> <p>INTERVIEWS OF PROPERTY OWNERS AND LOCAL RESIDENTS 12-137</p> <p>MONUMENT PERPETUATION 12-138</p> <p>SEARCH FOR UNRECORDED MONUMENTS 12-137</p> <p>VERIFICATION OF RECORD EVIDENCE 12-136</p> <p>INTRODUCTION 12-135</p> <p>MINIMUM STANDARDS 12-135</p> <p style="padding-left: 20px;">LINEAR FEATURE ACCURACY 12-135</p> <p style="padding-left: 20px;">POINT FEATURE ACCURACY 12-135</p> <p>REFERENCES 12-143</p> <p>RIGHT OF WAY SURVEY RECORDS 12-141</p> <p style="padding-left: 20px;">FIELD SURVEY RECORDS 12-143</p> <p style="padding-left: 20px;">RESEARCH RECORDS 12-141</p>
S	
<p style="text-align: center;">R</p> <p>RAILROAD SURVEYS</p> <p style="padding-left: 20px;">PROCEDURES 14-152</p> <p style="padding-left: 20px;">SAFETY 14-152</p> <p>REFERENCE SYSTEM 6-38</p> <p>REFERENCES 1-14</p>	<p>SAFETY</p> <p style="padding-left: 20px;">CREW CHIEF RESPONSIBILITIES 2-20</p> <p style="padding-left: 20px;">DEPARTMENT SAFETY AND HEALTH</p> <p style="padding-left: 40px;">POLICY 2-16</p> <p style="padding-left: 20px;">EQUIPMENT 2-18</p> <p style="padding-left: 20px;">INDIVIDUAL RESPONSIBILITIES 2-19</p> <p style="padding-left: 20px;">PRACTICES 2-19</p> <p style="padding-left: 20px;">SUPERVISOR RESPONSIBILITIES 2-20</p> <p style="padding-left: 20px;">TRAFFIC CONTROL 2-17</p> <p style="padding-left: 40px;">PROJECT CONTROL SURVEY 2-18</p> <p style="padding-left: 40px;">RECONNAISSANCE SURVEY OFF OF THE ROADWAY 2-17</p> <p style="padding-left: 20px;">TERRAIN DATA SURVEY 2-18</p> <p style="padding-left: 20px;">VEHICLE WARNING LIGHTING</p> <p style="padding-left: 40px;">STANDARDS 2-17</p> <p style="padding-left: 20px;">WORK ZONE ENHANCEMENTS FOR SHOULDER WORK 2-18</p> <p style="padding-left: 20px;">WORK AREA HAZARDS</p> <p style="padding-left: 40px;">CONFINED SPACES 2-19</p> <p>SECONDARY PROJECT CONTROL</p> <p style="padding-left: 20px;">DATA PROCESSING 9-89</p> <p style="padding-left: 40px;">HORIZONTAL 9-89</p> <p style="padding-left: 60px;">GPS 9-89</p> <p style="padding-left: 60px;">TPS 9-89</p> <p style="padding-left: 40px;">VERTICAL 9-90</p> <p style="padding-left: 60px;">DIFFERENTIAL LEVELING 9-91</p>

APPENDIX

TRIGONOMETRIC LEVELING	9-91
DATA QUALITY CONTROL	9-91
INTRODUCTION	9-80
MINIMUM STANDARDS	9-82
HORIZONTAL PROJECT CONTROL.....	9-82
GPS TECHNIQUES	9-82
TPS TECHNIQUES	9-82
VERTICAL PROJECT CONTROL.....	9-83
MONUMENTATION.....	9-81
BASELINE STATIONS	9-81
BENCH MARKS	9-82
PROCEDURES.....	9-83
HORIZONTAL PROJECT CONTROL.....	9-84
GPS PROCEDURES.....	9-84
TPS PROCEDURES	9-85
VERTICAL PROJECT CONTROL.....	9-87
DIFFERENTIAL LEVELING	9-87
TRIGONOMETRIC LEVELING	9-87
QUALITY CONTROL.....	9-94
REFERENCES	9-94
REPORTING	9-91
FIELD NOTES	9-91
HORIZONTAL	9-91
VERTICAL	9-91
SURVEY REPORTS	9-91
HORIZONTAL.....	9-92
VERTICAL.....	9-93
SIDE TRAVERSES.....	12-140
SPATIAL POSITIONING ACCURACY	
STANDARDS	
INTRODUCTION	5-33
PROCEDURES.....	5-33
REFERENCES	5-35
STANDARDS.....	5-33
STANDARDS	1-14
STATE PLANE COORDINATE SYSTEM	
DISTANCE CONVERSIONS	6-44
DOCUMENTATION.....	6-45
REFERENCES	6-45
UNITS OF LENGTH	6-42
SURVEY	
PROCEDURES.....	1-14
PURPOSE	1-13
REFERENCES.....	1-14
STANDARDS	1-14
 T 	
TERRAIN DATA SURVEYS	
DATA PROCESSING.....	11-128
FEATURE ATTRIBUTES.....	11-129
FIELD PROCEDURES.....	11-112
DIGITAL TERRAIN MODEL.....	11-121
LINEAR FEATURE LOCATION	11-116
POINT FEATURE LOCATION	11-112
INTRODUCTION.....	11-111
MERGING DIGITAL TERRAIN MODELS.....	11-129
MINIMUM STANDARDS	11-112
QUALITY CONTROL	11-132
SURVEY RECORDS.....	11-132
FIELD NOTES	11-132
TRAFFIC CONTROL.....	2-17
PROJECT CONTROL SURVEY.....	2-18
RECONNAISSANCE SURVEY OFF OF THE	
ROADWAY	2-17
TERRAIN DATA SURVEY	2-18
VEHICLE WARNING LIGHTING STANDARDS	
.....	2-17
WORK ZONE ENHANCEMENTS FOR	
SHOULDER WORK.....	2-18
 V 	
VEHICLE WARNING LIGHTING STANDARDS .	2-17
VERTICAL DATUM	6-42

APPENDIX

17.9 TABLE OF FIGURES

FIGURE I.	NYSPCS ZONES	6-40
FIGURE II.	NSRS in New York State	7-49
FIGURE III.	NYS DOT Survey Control Classifications.....	8-54
FIGURE IV.	Horizontal Primary Control Survey To Azimuth Pair Stations.....	8-60
FIGURE V.	Horizontal Primary Control Survey To Base Stations.....	8-62
FIGURE VI.	Horizontal Primary Control Survey From Base Stations to Azimuth Pair Stations	8-63
FIGURE VII.	Network Diagram Incorporating Bench Marks to Establish Vertical Control on Project Site.....	8-68
FIGURE VIII.	NYS DOT SECONDARY PROJECT CONTROL.....	9-81
FIGURE IX.	TYPICAL SECONDARY PROJECT CONTROL SURVEY.....	9-83
FIGURE X.	Photogrammetric Control.....	10-97
FIGURE XI.	NRTK Photogrammetric Control Survey.....	10-102
FIGURE XII.	Local RTK Photogrammetric Control Survey.....	10-103
FIGURE XIII.	Fast Static Photogrammetric Control Survey.....	10-104
FIGURE XIV.	Standard Feature Naming	11-117
FIGURE XV.	Shot Spacing Diagram.....	11-123
FIGURE XVI.	Cross Section Shot Pattern	11-124
FIGURE XVII.	No maximum segment length	11-128
FIGURE XVIII.	Maximum segment length	11-129
FIGURE XIX.	Bridge Plan	13-146
FIGURE XX.	Bridge Abutment/Pier	13-147
FIGURE XXI.	Bridge Section	13-147